

Pennsylvania's Traffic Calming Handbook

Pennsylvania Department of Transportation



Pennsylvania's Traffic Calming Handbook

Pennsylvania Department of Transportation
Bureau of Maintenance and Operations (BOMO)
Publication No. 383

PA Traffic Calming Handbook on the Web:

[Pub383ftp://ftp.dot.state.pa.us/public/PubsForms/Publications/PUB%20383.pdf](ftp://ftp.dot.state.pa.us/public/PubsForms/Publications/PUB%20383.pdf)

Cover Photos: Bucknell University, Pennsylvania
Peters Township, Pennsylvania
Municipality of Mt. Lebanon, Pennsylvania

July 2012

TABLE OF CONTENTS

- Chapter 1 INTRODUCTION _____ 1
 - History of Traffic Calming..... 2
 - Objectives of Traffic Calming 2
 - When Is Traffic Calming Appropriate? 3
 - Education 3
 - Enforcement..... 3
 - Engineering 4
 - Where are Traffic Calming Measures Appropriate? 4
 - PennDOT Policies..... 4
- Chapter 2 TRAFFIC CALMING ISSUES _____ 5
 - Funding..... 5
 - Emergency Service Vehicles 5
 - Streetscape Improvements 7
 - Snow Removal..... 7
 - Drainage 8
 - ADA Requirements 8
- Chapter 3 LEGAL ISSUES _____ 9
- Chapter 4 TRAFFIC CALMING STUDY AND APPROVAL PROCESS _____ 13
 - Preliminary Traffic Calming Process 13
 - Study and Approval Process..... 15
 - Statewide Pennsylvania Traffic Calming Survey..... 22
- Chapter 5 TRAFFIC CALMING MEASURES AND DESIGN GUIDELINES _____ 23
 - Selecting Potential Traffic Calming Measures 23
 - Overview of Measures 24
 - CURB EXTENSIONS / BULB-OUTS..... 26
 - CHICANES..... 29
 - GATEWAYS..... 32
 - ON-STREET PARKING 33
 - TRAFFIC CIRCLES 34

ROUNDBABOUTS	37
SPEED HUMPS	38
SPEED CUSHIONS/SPEED PILLOWS.....	48
RAISED INTERSECTIONS.....	50
DIAGONAL DIVERTERS.....	55
RIGHT-IN / RIGHT-OUT ISLAND	58
RAISED MEDIAN THROUGH INTERSECTION	61
STREET CLOSURES	63
PEDESTRIAN SAFETY ENHANCEMENT DEVICES	65
Chapter 6 USE OF SIGNS AND PAVEMENT MARKINGS FOR TRAFFIC CALMING ____	75
Signing.....	75
Speed Limit Signing	75
Multi-Way Stop Signs.....	75
Turn Prohibitions	76
One-Way Streets.....	76
Roadway Narrowing with Edge Lines	76
Transverse Markings.....	76
Chapter 7 TRAFFIC CALMING PLANNING AND DESIGN FOR NEW AND RECONSTRUCTED STREETS _____	78
Complete Streets	78
Smart Transportation	79
Speed Management.....	80
Traffic Calming Features for New Development	81
Street Network Elements:	81
Roadway Features:.....	81
Appendix A ADDITIONAL FINDINGS ON TRAFFIC CALMING ISSUES _____	82
Funding Issues.....	82
University of California Study Findings	82
Community Approval.....	83
Traffic Data Gathering Process.....	84
Determining Eligibility.....	84
Monitoring and Evaluation	84

Appendix B SOURCES	86
Interviews	86
Local Surveys	87
Statewide Pennsylvania Traffic Calming Survey	88
Survey Questionnaire	88
Survey Results	90
Summary of Survey	97
State Surveys	98
Texts	98
Web Sites	103
Appendix C TRAFFIC CALMING EFFECTIVENESS STUDIES	104
Appendix D EXAMPLE TRAFFIC CALMING POLICIES	109

LIST OF FIGURES

Figure 1 – Project Ranking System	14
Figure 2 – Traffic Calming Study and Approval Process (Flowchart)	15
Figure 3 – Effects of Traffic Calming Measures	25

Chapter 1

INTRODUCTION

Due to the use of traffic calming as traffic management tool for many municipalities in the State of Pennsylvania, the Pennsylvania Department of Transportation (PennDOT) has created the "Traffic Calming Handbook" (Publication 383) to provide new and additional information on traffic calming and how it can be used on the roadways of Pennsylvania. This Handbook contains information on various traffic calming issues such as legal authority, liability, funding, impacts on emergency services, as well as many others that were in the original publication.

Information in this handbook has been incorporated on the basis of a survey that was conducted of municipalities in the State of Pennsylvania on common devices and practices used. New devices used in the state and nationally have also been added to this publication. Finally, additional case studies on the expected effects of specific traffic calming measures are provided.

The Institute of Transportation Engineers (ITE) has developed a publication entitled "Traffic Calming Practice Revised". The ITE publication is an update to the original "Traffic Calming – State of the Practice". The ITE "Traffic Calming Revised" publication provides updated information about traffic calming, traffic calming programs around the country, and various other traffic calming issues. It is recommended that the ITE publication be used in conjunction with the "Pennsylvania's Traffic Calming Handbook" when formulating a traffic calming program for your community. ("Traffic Calming – State of the Practice" can be purchased or downloaded from the ITE web site at www.ite.org.)

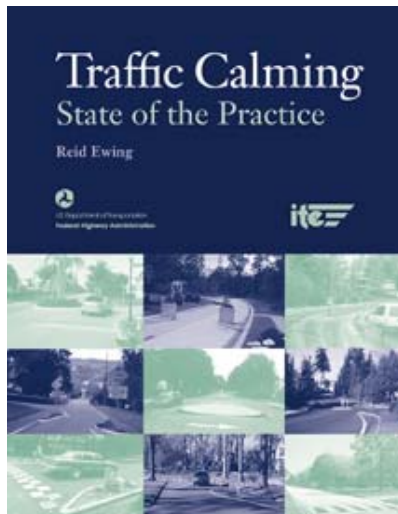

"Pennsylvania's Traffic Calming Handbook" also provides guidance for PennDOT when considering the use of traffic calming measures on State roadways in Pennsylvania, although most traffic calming devices in Pennsylvania are installed on local municipal streets. The Handbook is intended to provide municipalities with information that can help them establish a traffic calming program for roadways within their jurisdiction. In doing so, local municipalities may also need to modify the study and approval process to better reflect the conditions of their community.

This handbook is designed to supplement existing design policies and procedures and is not intended to replace or supersede any current requirements. The updated handbook also recognizes the new MUTCD requirements that now include many traffic calming devices, markings and signage. In addition the PennDOT smart transportation principals have been reviewed and incorporated as part of this update.

Finally this update recognizes the evolution of traffic calming into complete street design that addresses the need not to just calm vehicular traffic on streets but design for pedestrians, bicycles and other alternate modes. For any project that involves State or Federal money, or Liquid Fuels funds, the processes outlined in PennDOT's Design Manual Part 1 and 1A must be followed.

Using "Pennsylvania's Traffic Calming Handbook" and ITE's "Traffic Calming – State of the Practice" will help local governments update or formulate and document that a rational planning process has been followed in establishing their traffic calming program. Further, by basing a traffic calming program on these references, local governments in Pennsylvania may benefit from this updated information on the experience of other jurisdictions in Pennsylvania and nationwide while providing a degree of consistency for the public in encountering these measures.

Through the application of appropriate traffic calming principles, neighborhoods throughout Pennsylvania will be able to enjoy safer streets that are shared by motorists, pedestrians, and bicyclists alike.

History of Traffic Calming

Traffic calming began in the Netherlands in the 1960s with the design of “Woonerven”, or “living yards”. The “Woonerven” integrated motor traffic with pedestrian and bicycle traffic on shared street space. In the late 1970s, Germany began working in this area using the term “Verkehrsberuhigung” which would eventually be translated as “traffic calming”.

A number of communities in the United States began applying the principles of traffic calming in the late 1970s, at the same time that it was spreading to other European countries, Canada, and Australia. However, it has taken many years for traffic calming to gain popularity in America. As a result, many of the initial studies on the effects of traffic calming have taken place abroad, where its application has reportedly lowered crash and injury rates anywhere from 20 to 80 percent.

In the United States, traffic calming measures are rarely combined to the extent that they are in Europe. Although it has been much more common to see the installation of individual measures, an increasing number of jurisdictions have begun combining measures with good success.

Traffic calming measures are typically limited for use on local streets. However, they have been incorporated on collector streets with predominantly residential land uses and, less frequently, on streets through downtown business districts. Because traffic calming measures are designed to slow traffic and reduce cut-through volumes, they are generally not appropriate for use on arterial streets which are intended to accommodate higher speeds and larger traffic volumes.

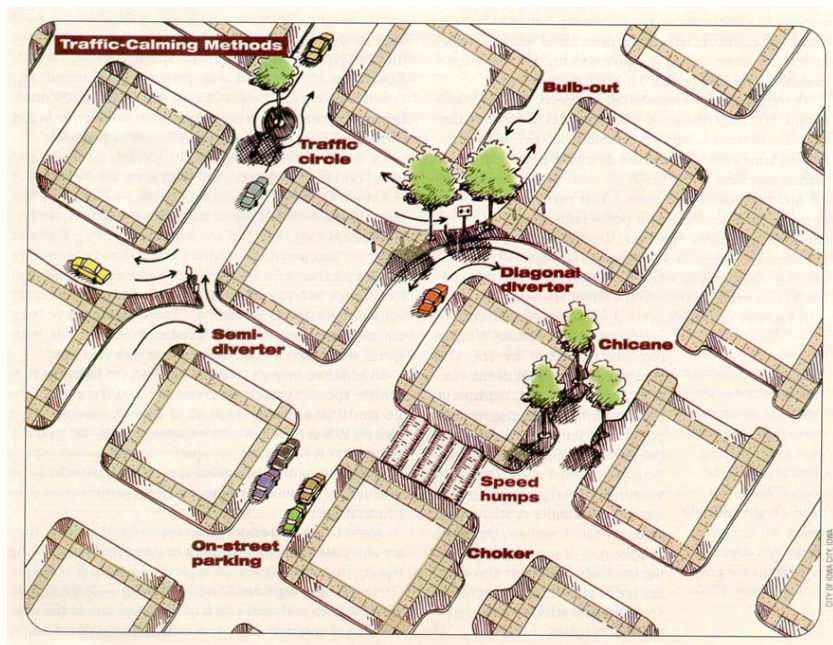

(Source: City of Iowa City, Iowa)

Many jurisdictions in the United States have evolved their traffic calming programs into complete streets policies that now apply to new and reconstructed streets as well as existing streets. The application of complete streets principals provides for enhancing travel for all modes not just vehicles.

Objectives of Traffic Calming

Traffic calming measures are mainly used to address speeding and high cut-through traffic volumes on neighborhood streets. These issues can create an atmosphere in which non-motorists are intimidated, or even endangered, by motorized traffic. Additionally, high cut-through volumes become an increased concern when larger commercial vehicles are involved. Along with the additional amount of traffic

generated within the neighborhood, cut-through motorists are often perceived as driving faster than local motorists. By addressing high speeds and cut-through volumes, traffic calming can increase both the real and perceived safety of pedestrians and bicyclists, and improve the quality of life within the neighborhood. The evolution of traffic calming into complete streets also recognizes that traffic calming measures can include devices that enhance safety and mobility for bicyclists and pedestrians such as sidewalks, bike lanes and other non-motorized mode enhancements.

ITE has defined traffic calming in the following way:

<h2 style="margin: 0;">Traffic Calming</h2>	<p>The combination of mainly physical measures that reduce the negative effects of motor vehicle use, alter driver behavior, and improve conditions for non-motorized street users.</p>
---	--

The role of physical measures in traffic calming has been emphasized because they are “self-policing”. This means that traffic calming measures, such as speed humps and traffic circles, have the ability to slow motor vehicles in the absence of enforcement. On the other hand, traffic control devices, such as, weight limits and one-way streets; depend upon the level of police enforcement and the willingness of motorists to comply with the posted restrictions to be effective. Therefore, the use of traffic calming measures can often lead to a more certain accomplishment of the neighborhood’s goals.

Traffic calming devices should not be confused with traffic control devices, which are outlined in the new MUTCD. Traffic control devices are all signs, signals, pavement markings, and other devices placed along roadways to guide and regulate the action of motorists on public roads. Traffic calming devices are used to strike a balance between vehicular traffic and everyone else who uses the streets through measures that are self-enforcing.

When Is Traffic Calming Appropriate?

Using a well-defined “Traffic Calming Study and Approval Process” will help determine when and where traffic calming measures are appropriate. Because traffic calming measures have the potential to create controversy, their installation often occurs as the final step of a three-step process referred to as the “three E’s” (education, enforcement, and engineering). However, this three-step process only addresses problems with speeding, not with cut-through volumes. If the first two steps are not effective in lowering speeds on neighborhood streets, the need for traffic calming measures becomes more apparent.

Education

Communities with educational programs seek to remind speeding drivers of the negative effects of their actions, often by stressing that the community’s children are the most at risk. Educational campaigns may use brochures or neighborhood newsletters to spread this message. Newsletters may also contain information on speeding fines (particularly in school zones), pedestrian and bicycle safety tips, and information on average speeds in the neighborhood.

Enforcement

Enforcement involves a more intensive police presence and a greater allocation of time to enforcing the speed limit in a particular neighborhood. Unfortunately, it is often not practicable to maintain a police presence at the level needed to permanently lower speeds. However, consistent visible enforcement does lead to respect of the speed limit by motorists.

Engineering

Engineering includes, but is not limited to, traffic calming measures. It can also include the use of signs and pavement markings to obtain the desired effect.

Prior to installing traffic calming measures on local or collector streets, traffic conditions on adjacent arterial streets should be investigated to determine if operational deficiencies are contributing to the identified traffic concerns. If the adjacent arterial streets are the responsibility of the local government, these deficiencies should be addressed before traffic calming is considered. In addition, when the use of traffic calming measures may divert large volumes of traffic from local streets, the effects on adjacent roadways should be addressed.

Where are Traffic Calming Measures Appropriate?

As outlined in the “Traffic Calming Study and Approval Process” (see Chapter 4), functional classification and land use should be primary criteria in determining whether traffic calming measures are appropriate for a particular roadway. When conditions warrant, traffic calming measures may be appropriate on the following roadway types (local or State-owned):

- ❑ Local residential streets
- ❑ Collector streets with predominantly residential land uses
- ❑ Arterial roads within downtown districts or commercial areas (with posted speeds of 40 mph or less)

PennDOT Policies

PennDOT supports the use of traffic calming measures. The use of Smart Transportation Principles and Complete Streets concepts are also encouraged by PennDOT to consider all modes not just in addressing issues on existing streets but the design of new or reconstructed streets. In addition, the *Traffic Engineering Manual*, Publication 46 is a supplement to the MUTCD to aid in the design, placement, and maintenance of signs on all State Highways.

Chapter 2

TRAFFIC CALMING ISSUES

Various issues can affect a traffic calming policy or project, regardless of the type or application of a particular measure. These issues include, but are not limited to, funding, impact on emergency service vehicles, landscaping, snow removal, drainage, and the Americans with Disabilities Act (ADA) requirements. This chapter provides information to help address some of the concerns in each of these areas.

Funding

Compared to other transportation expenditures for local governments, traffic calming program expenses are not large capital expenditures. Therefore, local governments have some flexibility in determining how to fund their programs. Local governments nationwide most frequently fund their traffic calming programs from capital improvement funds, general funds, or State gas tax subsidies. Some have also used other funding mechanisms such as assessments. Many governments require neighborhood residents to pay for installation and/or maintenance of traffic calming measures and accompanying landscaping, particularly if the project is low on the priority list. Experience has also shown that many traffic calming devices such as speed humps can be installed in conjunction with municipal paving programs.

In Pennsylvania, Liquid Fuels funds may be used for traffic calming measures listed in this Handbook provided that a well-defined "Traffic Calming Study and Approval Process" has been followed (see page 12 for exception relating to road closures). However, no money has been designated at the State or Federal level specifically for implementation of traffic calming projects. This means that traffic calming projects must compete with other types of projects, or measures can be included as part of a larger project, if State or Federal dollars are being requested.

For any project that involves State or Federal money, or Liquid Fuels funds, the processes outlined in PennDOT's Design Manual Part 1 and 1A must be followed.

When traffic calming measures are installed on State highways, a written agreement between the local municipality and PennDOT's local Engineering District must be established to outline funding responsibilities for installation, maintenance, pavement markings, and any other associated traffic control devices such as warning signs. This agreement will indicate that the funding for each of these areas will be the responsibility of the local municipality, unless otherwise agreed upon by PennDOT.

It is recommended that local governments determine how their traffic calming program will be funded before they begin to study identified areas. Doing so may help eliminate unnecessary work if monies will not be available to fund the implementation of traffic calming projects or the maintenance of measures after installation. Whenever Liquid Fuels funds are considered for a traffic calming project, the local municipality should contact PennDOT's Municipal Services representative in the local Engineering District Office.

Emergency Service Vehicles

Police departments generally have little opposition to (and often endorse) traffic calming measures because of their potential to reduce speeds and crashes. Fire departments may also recognize their benefit for increasing safety. However, emergency service providers may be slowed or inconvenienced by certain types of traffic calming measures. Generally, longer and heavier vehicles must slow to a

greater extent than passenger cars to negotiate various measures. For fire trucks, which are longer than normal passenger vehicles and have stiffer suspensions, sudden vertical deflection can be more jarring and may sometimes lead to discomfort for passengers. Traffic calming measures may have an even greater effect on ambulances that are transporting patients.

While many municipalities have successfully implemented traffic calming programs with no resistance from emergency service providers, it is important that they be consulted very closely when any traffic calming program is formulated and projects are identified. Many of the municipalities' have incorporated the following guidelines pertaining to traffic calming and emergency service vehicles:

- Include emergency service providers in the planning of traffic calming measures.
- A primary emergency response route study should be completed and traffic calming measures should not be permitted on the primary emergency service response routes.
- Devise a list of recommended traffic calming measures that can accommodate emergency service vehicles, including altering the design of current traffic calming measures to improve emergency vehicle maneuvering or to allow emergency access.

A major emergency response street is intended to service the longer, most direct legs of emergency response trips. Major emergency response streets were selected based on the following considerations:

- Eligibility of streets for traffic calming devices;
- Spacing/connectivity;
- Traffic classification;
- Location of fire stations; and
- Topography.

Municipalities may consider designating all collector roadways and higher arterial roadways as major emergency response streets. In addition, a potential guideline for designating any neighborhood collector roadway as an emergency response street is any roadways that accommodates less than seventy-five percent of residential traffic.

Other considerations also include developing the roadway network to connect all existing fire stations to the major emergency response streets and avoiding streets where topographic conditions would result in emergency vehicle delays. All streets that were not selected as major emergency response streets were designed as minor emergency response streets.

A minor emergency response street is intended to serve the shorter legs of emergency response trips. Minor emergency response streets are generally eligible for traffic calming devices and are designed and operated to provide access to individual properties.

Most traffic calming measures present little or no impact on emergency response time. Studies have demonstrated that speed humps and traffic circles typically create a delay of less than 9 to 11 seconds for fire trucks. One study on the effects of speed humps and traffic circles reported:

- ❑ 22-foot speed humps caused 0 to 9 seconds of delay
- ❑ 14-foot speed humps caused 1 to 9 seconds of delay
- ❑ Traffic circles caused 1 to 11 seconds of delay

Many local governments have responded to the fears that speed humps will increase response times by not permitting the installation of humps on major emergency response routes, or by permitting only Seminole County humps, which have a gentle profile (see Page 47). Further, design elements can be added to measures to improve emergency vehicle maneuvering and to allow emergency access. For example, traffic circles can be built with mountable aprons which allow fire trucks to pass through an intersection without compromising the measure's effectiveness in slowing passenger cars. Another example is the City of Portland, Oregon's "split" speed hump, which allows emergency vehicles to bypass the hump with horizontal rather than vertical deflection. Street closures and diverters can be designed with removable bollards that allow emergency access only.

Possessing an understanding of the traffic calming measure being considered, the location where it will be used, and the opinions of emergency service providers can work to strengthen a traffic calming program. The majority of emergency service provider concerns can be eliminated with a well-designed and properly implemented traffic calming program. As discussed in Chapter 4 of this Handbook, emergency service providers should be included on the Local Traffic Advisory Committee which oversees the preparation of a traffic calming plan or a jurisdiction-wide traffic calming program. Also, all major emergency response routes should be identified as part of the traffic calming plan process. With input from emergency service providers, the Local Traffic Advisory Committee will then have two options to consider when formulating its recommendations:

1. Only permit traffic calming measures with minimal or no impacts on emergency response times on major emergency response routes.
2. Alter the design of measures to improve emergency vehicle maneuvering or to allow emergency access.

Streetscape Improvements

When landscaping is considered in conjunction with traffic calming measures as part of a streetscape project, the local government may consider recruiting neighborhood volunteers for routine landscape maintenance and litter removal. Without community help, the costs associated with landscaping can sometimes be large. If there are no volunteers (or if volunteers diminish over time), the local government should consider using a low-maintenance landscaping plan.

When deciding what types of landscaping to use for a traffic calming measure as part of a streetscape project, one must always consider sight distance requirements and whether the landscaping will introduce "fixed objects" which may pose a potential hazard if struck by errant vehicles. In certain applications, large trees, rocks, and other similar objects could pose a potential hazard to motorists and pedestrians. In these situations, smaller shrubs and plants that do not pose a safety concern should be considered. Along with the safety concerns of introducing a "fixed object", the landscaping may also become a sight distance problem as the plants mature if they are improperly placed, not maintained, or if the wrong types of plantings are used. For this reason, it is important to consider plant type, growth, and location when landscaping is being considered.

Snow Removal

Many of the traffic calming measures identified in this Handbook may have an effect on the removal of snow and ice, with vertical deflection measures being the most difficult for the removal of snow and ice.

A study was conducted in Placer County, California by the Placer County Department of Public Works, to determine which traffic calming devices are considered appropriate in the snow. The study, *Placer*

County Neighborhood Traffic Management Program, dated February 28, 2007, identified the following traffic calming devices as potentially appropriate in the snow:

- Traffic circles;
- Textured pavement;
- Roundabouts;
- Rumble strips;
- Chicanes;
- Full street closures;
- Two-lane gateways restriction “chocker”;
- Radar speed signs; and
- Non-physical measures such as edge line striping and speed enforcement.

The study recommends that traffic calming measures should not be implemented on primary routes. It also noted that speed humps have a history of utilization in Pennsylvania and many municipalities report no issues with snow removal.

Therefore, measures should be clearly identified and equipment operators made aware of the types of measures that are installed. Doing so will improve the snow removal operation and help prevent damage to the snow removal equipment or the measure itself.

Drainage

The installation of traffic calming measures may change the drainage patterns of the roadways on which they are located. It is very important to review drainage characteristics when determining which measures are most appropriate. Otherwise, problems such as ice/water accumulation on a pedestrian crossing or roadway could occur. Drainage should always be considered and designed in accordance with the latest PennDOT standards.

ADA Requirements

Traffic calming measures must be designed to accommodate all people in the community. To accomplish this goal, measures that are implemented to improve pedestrian safety, or have an effect on pedestrian travel, must be designed to meet the requirements set forth in the Americans with Disabilities Act (see Chapter 3, Part 6, Page 12). However, the diagrams of the traffic calming measures in Chapter 5 are not intended to represent actual site conditions or to depict the requirements set forth by the Americans with Disabilities Act.

Chapter 3

LEGAL ISSUES

Hundreds of local governments across the country have implemented traffic calming programs. Few have encountered liability issues. Almost all lawsuits that have arisen have been dismissed, denied, or withdrawn. Where lawsuits have succeeded, they have done so not because a traffic calming measure was found inherently unsafe, but because signs or pavement markings were poorly maintained.

In order to minimize liability, municipalities should maintain documentation illustrating that their traffic calming programs are appropriate, and that the installations of traffic calming measures are based upon objective data. This documentation should also state the goals to be served by the traffic calming program, as well as the procedures to be followed when considering and installing any measure. Local governments should establish guidelines for speed, volume, and/or crash history conditions under which traffic calming measures may be installed. Establishing a "Traffic Calming Study and Approval Process" (see Chapter 4) for the local jurisdiction can help accomplish this goal.

Since governments may be held liable for any foreseeable condition, a traffic calming measure should be designed so that a driver acting reasonably and exercising ordinary care would perceive the intent of the measure and safely negotiate it. To do this, geometric design, signing, pavement markings and lighting should conform to standard engineering principles as much as possible.

This chapter addresses several of the legal questions that may pertain to the installation of traffic calming measures. This information is intended to provide general guidance and is not intended to provide specific legal advice for any particular installation. Users of this information should check for any changes in the law that may affect these principles.

(1) Does a municipality or PennDOT have the legal authority to install a particular traffic calming measure?

Curb extensions / bulb-outs (areas of expanded curbing) and chicanes (alternating curb extensions) are used to provide protection for pedestrians and parked vehicles, and to reduce traffic volumes and/or speeds. Although they affect traffic patterns, they are not traffic control devices, or police power measures taken under Section 6109 of the Vehicle Code, 75 Pa. C.S. §6109. These measures must conform to the State's or municipality's power to set highway width. See, e.g., 36 P.S. §670-513 (Secretary of Transportation determines State highway widths in boroughs).

Traffic circles (rotary traffic islands) are authorized by Sections 3308 and 6109(a) (4) of the Vehicle Code, 75 Pa. C.S. §§3308, 6109(a) (4), provided that they are marked with traffic control devices. In addition, Sections 102 and 3311 of the Vehicle Code define and authorize "divided highways," which may include traffic circles (rotary traffic islands). 75 Pa. C.S. §§102, 3311.

Crosswalks, including those that are raised, textured, or in connection with speed humps, are authorized by Sections 6109(a) (16) and (17) of the Vehicle Code. 75 Pa. C.S. §6109(a) (16), (17). There is no mention of how the crosswalk must be designed; therefore, there should be no prohibition against using raised or textured designs. The engineering study that justifies the crosswalk should contain justification for the use of the raised or textured design, or the inclusion of speed humps as an integral part of the crosswalk.

Speed humps that are not connected with crosswalks may be permissible as traffic control devices, although there is no specific statutory provision addressing them. Therefore, they fall under the general

police power. 75 Pa. C.S. §6109. As traffic control devices, they are authorized by Sections 6109(a) (2) and 6122(a) of the Vehicle Code. 75 Pa. C.S. §§6109(a) (2), 6122(a).

The use of medians and median barriers, including diagonal diverters and semi-diverters, is authorized by the Vehicle Code. Medians and median barriers fall under the general police power, 75 Pa. C.S. §6109(a). See *Wolf v. Department of Highways*, 422 Pa. 34, 220 A.2d 868 (1966) (characterizing installation of median barriers as exercise of police power). Medians and median barriers fall under the Vehicle Code's definition of "official traffic control devices," which includes "signs, signals, markings and devices not inconsistent with [the Vehicle Code] placed or erected by authority of a public body or official having jurisdiction, for the purpose of regulating, warning or guiding traffic." 75 Pa. C.S. §102. Sections 6109(a) (2) and 6122(a) of the Vehicle Code give PennDOT and local authorities' specific authority to place official traffic control devices. 75 Pa. C.S. §§6109(a) (2), 6122(a).

Each of these traffic calming measures, or any other measure identified in this Handbook, should only be installed after an engineering study has been conducted. Studies should be conducted in accordance with an established "Traffic Calming Study and Approval process" (see Chapter 4) and 67 Pa Code, Publication 46, whenever applicable.

Many of the traffic calming measures identified in this Handbook involve placement of official traffic control devices, including speed limit signing, turn prohibitions, roadway narrowing with edge lines, traverse markings, etc. These are authorized by 75 Pa. C.S. §§6109 and 6122. Municipalities that wish to place traffic control devices on any road in their jurisdiction must follow the procedures set forth in the Vehicle Code and Commonwealth regulations, which involves a study, then an ordinance, then traffic control devices, plus PennDOT approval when required. The procedure may require a municipality to obtain a highway occupancy permit if a traffic control measure will alter or significantly affect access to a State highway. See 67 Pa. Code Chapter 441 (pertaining to permits for driveways and local roads).

(2) Will there be a tort liability impact?

To establish municipal or PennDOT liability, an injured party must establish that it has a negligence claim that is traditionally recognized by the courts, and that the claim falls within a specific waiver of immunity. See, e.g., 42 Pa. C.S. §8522 (pertaining to sovereign immunity). To establish negligence, the injured party must establish that the government entity owed a duty to that person, that the duty was breached by an act or failure to act, that the breach of duty was the proximate cause of the injury, and that the injured party has suffered compensable damages. *Commonwealth v. Hickey*, 582 A.2d 734 (Pa. Cmwlth. 1990). Municipalities and PennDOT have the duty to make their highways safe for the highway's intended purpose. See *Bendas v. White Deer Township*, 531 Pa. 180, 611 A.2d 1184 (1992) (pertaining to State highway liability).

Traffic calming measures could potentially create an undesirable situation if they are improperly located, designed, installed, or maintained. They may cause injuries if, for example, an accumulation of ice and snow is not removed in a reasonable amount of time, if the measure is installed but its presence is not indicated by appropriate signs or markings, if it serves to place pedestrians at peril, or if it serves as an obstruction or vaulting hazard.

If these threshold requirements are met, an injured party must still meet the requirement that the government entity had adequate notice of the dangerous condition. The injured party must then show that statutory immunity has been waived for the type of claim asserted under the Sovereign Immunity Act, 42 Pa. C.S. §§8521-8528, or the Political Subdivision Tort Claims Act, 42 Pa. C.S. §§8541-8564. Under the Sovereign Immunity Act, PennDOT can be liable for claims arising from a dangerous condition of Commonwealth real estate. As examples, improper design and maintenance of traffic control devices has been determined to be a dangerous condition of the highway, See, e.g., *Bendas v. White Deer Township*, 531 Pa. 180, 611 A.2d 1184 (1992), but failure to remove natural accumulations of ice and snow has not. *Huber v. Department of Transportation*, 551 A.2d 1130 (Pa. Cmwlth. 1988).

(3) Can installation of a traffic calming measure constitute a taking?

Eminent domain cases come generally in two types. *Consequential damages* are injuries to property occurring as a natural result of an act lawfully done, but not amounting to a taking of the property. These damages are recoverable only when a particular law (e.g., the Eminent Domain Code) specifically allows. A *de facto taking* occurs when exceptional circumstances amount to the substantial deprivation of the use and enjoyment of the property. Both types have a causation requirement. If the damage to the property is not the direct, immediate, necessary, and unavoidable consequence of the government's actions or activities, there can be no recovery in eminent domain.

An abutting property owner has a constitutionally protected right of access to an existing non-limited access public highway. This is a private property right, distinguishable from the general public's right of passage. *Breinig v. Allegheny County*, 332 Pa. 474, 480, 2 A.2d 842, 847 (1938). This right extends only to ingress and egress to and from the property, and reasonable and conventional connection to the road system from there. *Wolf v. Department of Highways*, 422 Pa. 34, 220 A.2d 868 (1966). This right does not entitle the abutting landowner to access at all points along the highway. It also does not include a right to the traffic passing the property because an individual, even if his or her property abuts the road in question, has no legally recognized interest in a particular flow of traffic on a highway. *Carlino v. Whitpain Investors*, 499 Pa. 498, 453 A.2d 1385 (1982).

Placement of devices that hinder access, such as median barriers, are a taking where the hindrance is permanent and substantial. A court will look at the nature of the hindrance to determine whether it is substantial. *Department of Transportation v. Richards*, 556 A.2d 510 (Pa. Cmwlth. 1989). For example, in one case, a court decided that a hindrance that resulted in a four-mile detour to gain access to the property was not substantial. *In re Schaeffer*, 644 A.2d 1274 (Pa. Cmwlth. 1994). But in another case, a hindrance that resulted in a four-mile detour was substantial because it required truck traffic to drive through steep residential neighborhoods to access the property. *Jackson Gear Co. v. Department of Transportation*, 657 A.2d 1370 (Pa. Cmwlth. 1995). The question of whether the hindrance is substantial, and therefore a taking, will be made on a case-by-case basis.

In addition, placement of curbing, fencing, or other measures along the abutting property is a taking where it directly interferes with access to the property. *Tracy v. Department of Transportation*, 402 A.2d 286 (Pa. Cmwlth. 1979).

(4) How are existing design and maintenance policies impacted?

Municipalities and PennDOT must follow their existing design and maintenance policies and procedures. In particular, PennDOT design standards must be followed for any installations on or along State highways. Any standard design specifications developed for potential installations should be consistent with, and incorporated into, existing design specifications, and exceptions from existing approved design standards should be documented and justified in accordance with the appropriate design exception procedures. Any signs or markings used should similarly comply with PennDOT standards and approval procedures.

The maintenance of areas beyond curb lines is covered by Circular Letter E-2211, RM 93-04, and portions of the Maintenance Manual, particularly Chapter 8. PennDOT's curb-to-curb maintenance policy typically requires local control and maintenance of curbing and sidewalks. Traffic calming-based projects on State highways that alter curbing and sidewalks, such as construction of bulb-outs or chicanes, may affect the allocation of maintenance responsibility. PennDOT and any affected municipalities should negotiate future maintenance responsibility and execute a written agreement formalizing any changes of responsibility before undertaking the project.

(5) Will installation of traffic calming measures affect the road's eligibility for Liquid Fuels funds?

Any road closure, whether by erection of a mobile barrier or gate, restriction of use to local traffic only, or otherwise, can serve to deprive the road of its public character by limiting its use, rendering the road ineligible for assistance from the Liquid Fuels fund. See 72 P.S. §2615.4(1) (providing that Liquid Fuels allocations may be used for public roads or streets).

(6) Other legal concerns

The Americans with Disabilities Act, 42 U.S.C. §12101 et seq., requires the removal of architectural barriers to the disabled, and Federal regulations mandate the installation of curb ramps or slopes to accommodate access to streets. 28 C.F.R. §35.151(e). Traffic calming measures must be designed, installed, and maintained so as not to impede the mobility of individuals with disabilities. In addition, any alteration to the facility that affects its usability, such as installation of a physical device in the street, or a change to the curbing or sidewalk, triggers the obligation to construct curb ramps or other appropriate accommodations to the entire facility. 28 C.F.R. §35.151(b).

Traffic calming devices may not be used to improperly discriminate against the presence of certain large trucks in a community. Pennsylvania law prohibits vehicles more than 8½ feet (102 inches) wide from using Pennsylvania highways. 75 Pa.C.S. §4921(a). The Surface Transportation Assistance Act, 49 U.S.C. §31111-31115, also indicates that vehicles up to 102 inches wide may be operated on the Interstate System and qualifying federal-aid highways. *Id.* Moreover, 102-inch-wide tractor-trailer combinations must have reasonable access to that system from terminals, facilities for food, fuel, repairs, and rest, and points of loading and unloading for household goods carriers, motor carriers of passengers, or maxi-cube vehicles and vehicles with twin trailers. 49 U.S.C. §31113. U.S. Department of Transportation regulations define "terminal" as any location where: (1) Freight either originates, terminates, or is handled in the transportation process; or (2) Commercial motor carriers maintain operating facilities. 23 C.F.R. §658.5. PennDOT determines what access is reasonable by an access review process. Through that process, "[a] State may deny access to terminals and services . . . on the basis of safety and engineering analysis of the access route and, in the case of 102-inch wide vehicles, the characteristics of specific routes (in particular, significant deficiencies in lane widths)." 50 Fed. Reg. 22,758, 22,761 (June 1, 1990); See also, 23 C.F.R. §658.19(i) (2) (ii) (C). Denial of access is only allowed on the basis of safety. *Id.* Communities may see traffic calming measures that narrow road width as a solution to heavy volumes of large trucks. Local ordinances that establish measures designed solely to unreasonably restrict access to 102-inch-wide truck combinations will be subject to legal challenge.

Chapter 4

TRAFFIC CALMING STUDY AND APPROVAL PROCESS

As previously stated, traffic calming measures should typically be considered only after education and enforcement efforts have failed to produce the desired results. Also, traffic calming measures should be installed only after the existing traffic conditions have been thoroughly analyzed, traffic conditions that will be created after the measures have been implemented are studied, and the necessary approvals have been received. To guide you through this process, the “Traffic Calming Study and Approval Process” depicted in Figure 2 has been developed. This process has been formulated from traffic calming study and approval processes used throughout the country and includes items that are specific to traffic calming in Pennsylvania. This study and approval process can be used as is, or it can be modified to better reflect local conditions. This Figure 2 process represents a very comprehensive process to address traffic calming issues for a community that desires an ongoing mechanism to address multiple issues. Municipalities with staffing and resource limitations may need to develop a more simplified study and approval process, and examples of these simplified processes are provided in Appendix D. Each box in Figure 2 corresponds to a step or sub-step further identified in this chapter.

This “Traffic Calming Study and Approval Process” is designed as a supplement to existing policies and procedures and is not intended to replace or supersede any current requirements. For any project that involves State or Federal money, or Liquid Fuels funds, the process outlined in PennDOT’s Design Manual Part 1 and 1A must be followed.

If traffic calming is requested for a State road, or if State, Federal, or Liquid Fuels funds are used, approval from the local PennDOT Engineering District will be required. In certain situations, the local PennDOT Engineering District may require more information than what is identified in this Handbook and use more rigorous requirements for the State highways under their jurisdiction. It is important to check with the local Engineering District before starting the study and approval process for a State highway to determine any additional requirements or modifications that may be needed. This flexibility is necessary to account for the wide variation of traffic conditions that exist throughout the Commonwealth. Whenever a traffic calming measure is requested for a State road, a legal agreement between PennDOT and the local municipality identifying installation and maintenance responsibilities must be established.

Not all traffic calming projects will require the use of the “Traffic Calming Study and Approval Process” described in this chapter before implementation of a measure. Some traffic calming measures such as islands and bulb-outs are currently used routinely without any resistance from the community. Good engineering judgment will indicate when and where this type of approval process is necessary.

Because community involvement is critical to the traffic calming plan development process, the process (including plan development) will be managed by the local government for both State and local roadways. PennDOT approval for traffic calming measures on State roadways is identified in Step 3 of the study and approval process. For local roads not subject to State, Federal, or Liquid Fuels funding, PennDOT approval/involvement is not necessary but may be requested by the local municipality.

Preliminary Traffic Calming Process

Several areas should be addressed before beginning a traffic calming program. Addressing these areas can help ensure that you obtain the best results from your program.

- A. **Funding:** As previously indicated in Chapter 2, local governments should determine how their traffic calming program will be funded before they begin to study identified areas. This also includes the funding for maintenance of traffic calming measures after installation.
- B. **Project Ranking System:** It may be desirable to establish a ranking system to prioritize projects that meet the criteria established in the study and approval process. Sufficient funding may not be available to complete all of the traffic calming projects identified. Therefore, the ranking system will help establish the order in which projects will be completed. Figure 1 is an example of a "Project Ranking System". Local municipalities should develop a project ranking system that addresses the needs of the local community.

**FIGURE 1
PROJECT RANKING SYSTEM**

Criteria	Points	Basis for Point Assignment
Speed	0 to 30	Extent by which 85 percentile speeds exceed posted speed limit; 2 points assigned for every 1 mph.
Volume	0 to 25	Average daily traffic volumes (1 point assigned for every 120 vehicles).
Crashes	0 to 10	1 point for every crash reported within past 3 years.
Elementary or Middle Schools	0 to 10	5 points assigned for each school crossing on the project street.
Pedestrian Generators	0 to 15	5 points assigned for each public facility (such as parks, community centers, and high schools) or commercial use that generates a significant number of pedestrians.
Pedestrian Facility	0 to 10	5 points assigned if there is no continuous sidewalk on one side of the street; 10 points if missing on both sides.
Total Points Possible	100	

There may be existing conditions, other than what is included on your project ranking system, that warrant the need for traffic calming. Establishing the ranking for these traffic calming projects will require the use of engineering judgment.

- C. **Local Traffic Advisory Committee (LTAC):** The LTAC is a standing committee which coordinates all requests for traffic calming measures made within a local jurisdiction. This committee typically includes a municipal/county engineer, a municipal/county planner, a representative from the governing body, a representative from emergency services, one or more local citizens, and a representative from public works. If the local jurisdiction does not have an LTAC, it is recommended that the local government establish one.

FIGURE 2
TRAFFIC CALMING STUDY AND APPROVAL PROCESS

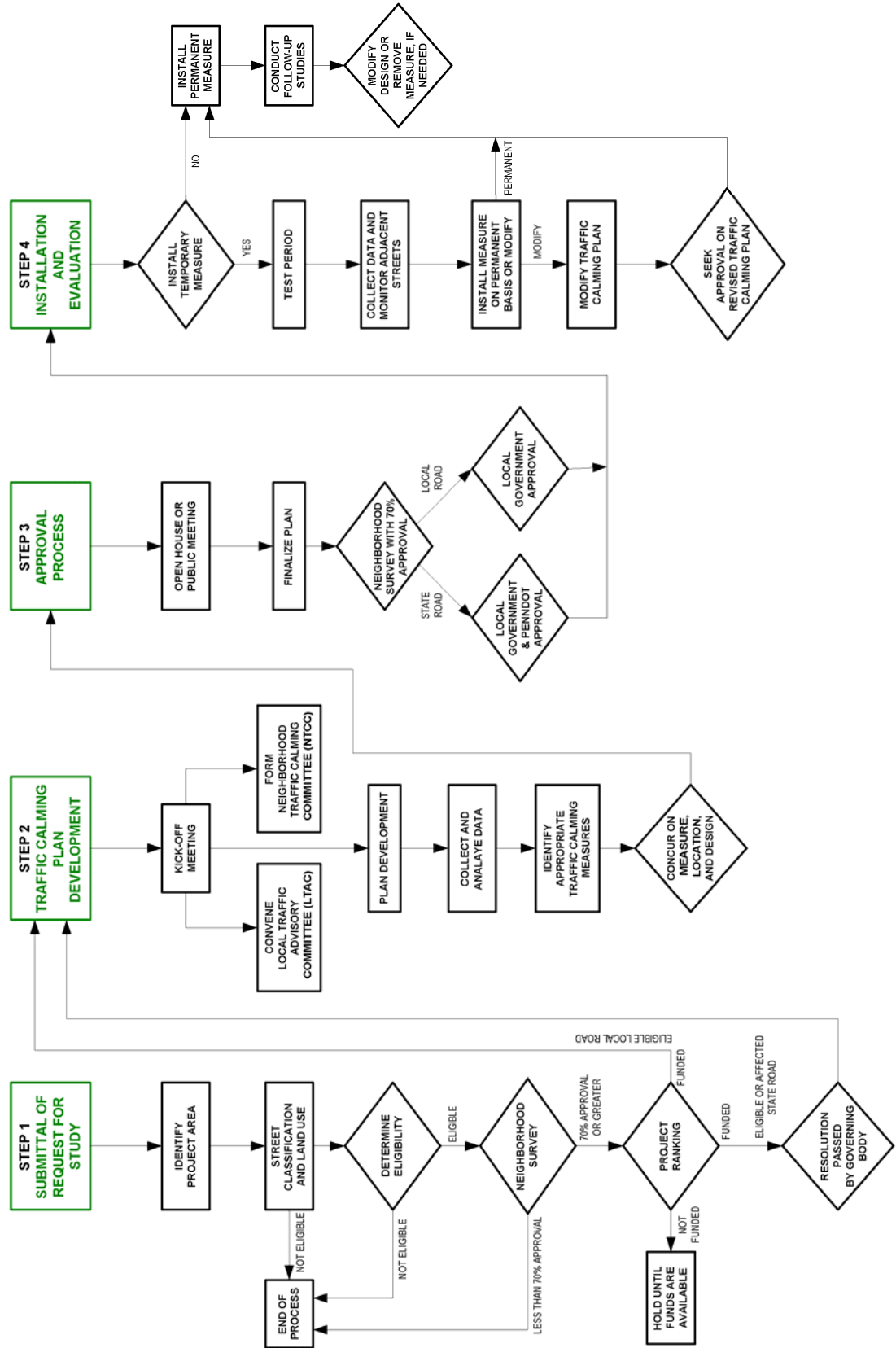

Study and Approval Process

Step 1: Submittal of Request for Study along with Supporting Data

- A. **Request for Study:** A neighborhood group or a local official formally submits a request to the municipal engineer and/or the LTAC for a traffic calming study at a particular location within the municipality.
- B. **Collect and Compile Supporting Data:** After the request for study has been reviewed, the local government or a neighborhood group must gather preliminary information such as project area, street classification, and land use to determine if the project warrants further study and evaluation. The following is a brief description of the preliminary information needed:

1. Identification of Project Area: The local government or neighborhood group must first determine the project area, or the area that would be affected by the installation of traffic calming measures. The project area will also be used to designate the neighborhood from which community approval must be sought throughout the study and approval process. (Generally, land owners along arterial streets should not be included for community approval purposes since arterial streets are designed to accommodate the higher speeds and volumes which are undesirable on local streets. Arterial streets, however, can be included if they serve a downtown district.) The project area should include the study street, cross streets on either side of the measure(s), any street which relies on the study street for access, and the two parallel local service streets. Other local streets that may be affected by the implementation of the traffic calming measures should also be included.

As noted under “Engineering” on Page 4, if affected arterial streets are the responsibility of the local government (i.e., not State roads), it may be beneficial to identify and address any traffic related problems before implementing traffic calming measures on the study street. Otherwise, traffic calming measures could result in increased traffic on the arterial street which, in turn, could make the problems worse.

2. Street Functional Classification and Land Use: Traffic calming measures may be considered on the following roadway types (local or State-owned) based on functional classification, land use patterns, and posted speed limits:

- Local residential streets
- Collector streets with predominantly residential land uses
- Arterial roads within downtown districts or commercial areas

(with posted speeds of 40 mph or less)

(Whenever necessary, the municipal engineer may be required to provide assistance in identifying the functional classification of project area roadways.)

Although traffic calming measures may be appropriate in downtown districts and commercial areas, the applications are typically limited to less intrusive types of traffic calming measures, such as bulb-outs and mid-block islands. In locations where posted speed limits are 30 mph or less, a wider variety of measures may be appropriate, especially where pedestrian activity is high.

Many Pennsylvania and U.S. numbered traffic routes are intended to serve a large percentage of through traffic. On these routes, traffic calming measures may be inappropriate. State and U.S. routes where truck volumes are 5 percent or greater may indicate that goods movement is an important function of the highway and traffic calming measures may be undesirable.

After the project area, street classification, and land use have been determined, the local government must decide if the traffic calming project meets the necessary preliminary requirements to be considered for traffic calming measures. If it does, then the study and approval process should be continued. If the preliminary requirements are not met, the neighborhood group or the local official that initiated the "request for study" should be notified why traffic calming is not appropriate at that location.

As previously stated, if traffic calming is requested for a State road, or if State, Federal, or Liquid Fuels funds are used, approval from the local PennDOT Engineering District is required. Preliminary discussions between the local municipality and PennDOT should occur prior to beginning the "Neighborhood Traffic Calming Survey" identified below. This way major concerns can be addressed before the community is involved.

3. Document Speeding or Cut-Through Problem and Determine Eligibility. At the beginning of a study, the following data should be gathered (by qualified technical personnel) to provide evidence that a traffic problem exists. The traffic studies that are conducted for a traffic calming program should be conducted in accordance with PennDOT Publication 46, Traffic Engineering Manual and PennDOT's, Policies and Procedures for Transportation Impact Studies, wherever applicable.
 - ❑ *Average daily traffic (ADT) volume.* As a minimum requirement, the ADT should exceed 1,000 vehicles/day or the peak hour volume should exceed 100 vehicles for the roadway to be considered for traffic calming.

Depending on the traffic problem that is being addressed, one of the following criteria should be considered:

- ❑ *Speeding:* When speeding is the primary concern, the 85th percentile speed should exceed 10 mph over the posted speed limit before traffic calming is considered.
 - 85th percentile speed. (The 85th percentile speed is the speed at or below which 85 percent of the motorists on a street are traveling. This speed is often used as a measure of the upper limit of reasonable speeds for prevailing conditions.)
- ❑ *Cut-through:* When cut-through traffic is the primary issue, the cut-through traffic on the local residential street should be 40% or more of the total one hour, single direction volume. In addition, a minimum of 100 cut-through trips in one hour, in one direction, should be set as a minimum requirement.

This minimum criterion may need to be modified to better reflect local traffic conditions. Experience has shown that the speeding criteria of 10 mph over the posted speed maybe higher than many municipalities consider acceptable and that a criteria of 5-7mph have been used in some municipalities. Any criteria for traffic volume, average daily traffic or cut-through traffic, should be based upon local experience and preference. In addition, use of the cut-through criteria has shown that collection of data to support evaluation of this criteria can require extensive resources and could be a potential issue. Details on speed and cut-through traffic data collection are provided in ITE's, Manual of Transportation Engineering Studies, Second Edition.

4. **Neighborhood Traffic Calming Survey:** Community approval is one of the most important steps in any traffic calming program. The best way to determine community approval is through a neighborhood survey. To do this, the local government, the LTAC, or the interested neighborhood group must compile a list of all residents and businesses in the project area and conduct either a mail or door-to-door inquiry to document interest in the traffic calming project. Using a range of 50% to 70% approval from the households and businesses is a good basis for further traffic calming studies (or use a 30% disapproval response with all non-responses being recorded as favorable). The traffic calming process should not move forward from this point until the minimum requirement is obtained.
- C. **Project Ranking:** After the required studies have been completed for a potential project, the project should be compared with other pending projects using an established "Project Ranking System". Projects for which funding is available can proceed through the remaining steps of the study and approval process. If money is not available to fund all of the projects, the lower ranked projects will need to be put on hold until additional funding is identified. A project ranking system is presented in Figure 1, on page 14.
 - D. **Pass Resolution:** To demonstrate local government support for traffic calming projects on State roads, or for projects on local roads which are anticipated to have a major effect on State roads, the local legislative body generally must pass a resolution approving further study. If the traffic calming project is on a State road, this resolution must then be reviewed by PennDOT to determine if the conditions warrant further study.

Step 2: Traffic Calming Plan Development

- A. **Kick-off Meeting:** The first step in the development of the traffic calming plan is to hold a "kick-off" meeting. This meeting should be conducted by the local government's traffic engineer (and/or planner or other personnel). All households and businesses that will be affected by the installation of the traffic calming measure(s) should be invited to this meeting. The meeting should be held at a time and place that facilitates maximum participation by those affected. Representatives from the jurisdiction's governing body, emergency service departments (fire, police, and rescue), public works departments, local schools, and the transit agency should also be invited to attend. Finally, the traffic consultant retained to prepare the traffic calming plan (if applicable) should be included. It is important that all of these entities be included in the development of the traffic calming plan to ensure that the project addresses all the needs and concerns of the community.
- B. **Neighborhood Traffic Calming Committee (NTCC):** A NTCC should be developed from the residents that attended the initial meeting(s). This committee will help provide focus to the plan development process by providing a link between the neighborhood and the municipality. The NTCC can also help assist the municipal engineer and the LTAC in organizing future community events, reviewing preliminary traffic calming plans and reports, and other areas where neighborhood participation is needed.
- C. **Local Traffic Advisory Committee:** At this point, the LTAC should be convened to oversee the development of the traffic calming plan.
- D. **Plan Development:** The municipal engineer, with assistance from the LTAC and the NTCC, should gather more extensive data that can be used to further define the traffic problem affecting the neighborhood. In addition, the data may help identify appropriate solutions or define which traffic calming measures are appropriate for the particular application. Although LTAC and NTCC personnel can assist in this endeavor, traffic data collection and analysis must be performed by appropriate traffic engineering or technical personnel.

1. Collect and Analyze Data: The following data may be helpful when determining appropriate solutions to the traffic problems at a particular location:
 - ❑ Speed – average speed and 85th percentile speed (previously discussed).
 - ❑ Volume – daily and peak hour volumes on the project street and other streets within the project area. If cut-through traffic volumes are believed to be excessive, a license plate survey could be conducted along with turning movement counts.
 - ❑ Adjacent arterial roads – determine if problems on area streets are related to poor traffic conditions on adjacent arterial roads. In this case, deficiencies on the arterial streets should be addressed first if they are the responsibility of the local municipality.
 - ❑ Crashes – crash data, by type, for the most recent three years.
 - ❑ Parking – location, capacity, and use.
 - ❑ Pedestrian and bicycle activity – identify vulnerable groups like children and the elderly.
 - ❑ Emergency service routes – identify major and minor emergency response street as detailed in Chapter 2, Emergency Service Vehicles.
 - ❑ Transit routes.
 - ❑ Locations of schools, parks, and other such facilities.
 2. Identify Appropriate Traffic Calming Measures: After the traffic data has been compiled, appropriate traffic calming measures can then be identified. Chapter 5, Traffic Calming Measures and Design Guidelines, provides information about a number of different traffic calming measures to assist in this effort. Identifying appropriate measures includes the following:
 - ❑ Identification of which traffic calming measures are designed to solve the documented problems.
 - ❑ Appropriateness of a particular traffic calming measure to the location where it will be installed.
- E. **Concur on Measure, Location, and Design:** At this point, the project engineer should present the findings of the data analysis to the NTCC and LTAC. Also, the engineer should describe which traffic calming measures are best able to address the problems identified, and discuss neighborhood opinions about traffic calming. Through this and subsequent meetings, the local government, the NTCC, and the LTAC should work toward a consensus on the most appropriate traffic calming measures, their design, and specific locations.

Step 3: Approval Process

- A. **Open House or Public Meeting:** Once consensus has been reached by the local government and the traffic calming committees, the preliminary and final traffic calming plans should be presented at an open house or public meeting. Notices for these meetings may be distributed door-to-door, mailed, or announced via a press release. The community should typically be presented with a single plan, with options for specific locations. Then, if necessary, plans may be modified before they are submitted to the community for approval.

- B. **Finalize Plan:** Following public review, any necessary modifications are made to the traffic calming plan. Additional public meetings can be held if the changes are very substantial. Otherwise, the plan is ready for community approval.
- C. **Neighborhood Survey:** Once the traffic calming plan is completed, a second neighborhood survey should be conducted. A 70% approval threshold should again be used to indicate continued community support for the traffic calming project. If less than 70% is obtained, additional modifications to the plan may be needed.
- D. **Local Government and PennDOT Approval:** After 70% community approval is obtained, the traffic calming plan must be officially approved by the local government. At this point, the funding source should be clearly identified and money set aside for implementation and maintenance. If the project involves a State road, or if State, Federal, or Liquid Fuels funds are requested, PennDOT approval is also required. This approval will include the issuance of a highway occupancy permit. When a State road is involved, a legal agreement between PennDOT and the local municipality identifying the installation and maintenance responsibilities must be established.

Step 4: Installation and Evaluation

After the traffic calming plan is approved by the neighborhood, the local government, and PennDOT (when State highways are involved), the traffic calming measure(s) can be installed on either a temporary or permanent basis.

- A. **Temporary Measure:** Temporary measures should be considered if traffic flow may be severely affected by the installation of traffic calming measures. After installation, traffic patterns and community approval may not be as expected. Temporary measures provide an opportunity to review the design in the field without a major removal expense if the project does not satisfy the original goals. If traffic calming measures are installed on a temporary basis, the temporary measures should resemble the permanent measures as much as possible, and should be marked, signed, and lit as if they were permanent measures. In addition, they must be designed using crashworthy devices so that they do not impose a safety hazard if struck by an errant vehicle. At times, jurisdictions have used temporary measures that were so unsightly that the neighborhood rejected the use of traffic calming measures altogether. However, particularly for programs that are just getting started, temporary installations provide a valuable means for the local government to gauge the depth of community support for measures that many citizens may be unfamiliar with. As a program develops and citizens gain greater familiarity with certain traffic calming measures, testing becomes less critical. For example, Seattle, Washington has installed over 600 traffic circles. Because there are so few resident requests for the removal of the circles, the City decided to install all measures on a permanent basis.

Test Period: When temporary measures are installed, a three to twelve-month test period should be considered. In most cases, a three to six-month test is sufficient. Measures, such as diverters, that significantly alter traffic patterns may require a six to twelve-month test period. In Pennsylvania, the test period should extend into the snow season whenever possible. This will provide the opportunity to detect any snow removal problems that may exist as a result of using the traffic calming measure. After the measure has been in-place for the specified time period, engineers or technical personnel should gather appropriate speed, volume, and other data to determine whether the measure has had the desired effect. The test period also provides the neighbors with the opportunity to decide whether the advantages gained from slower vehicle speeds, lesser volumes, and, in many cases, safer streets are worth the extra braking, the noise that some measures produce, extra seconds added to an emergency response call, longer trips to and from home, and other associated effects. Adjacent streets should also be monitored to verify that traffic problems have not shifted elsewhere. Many communities also use the

temporary installation period to test the impact on emergency service vehicles. Some communities have reported that the fears of citizens regarding the effects of traffic calming measures on emergency response times are allayed when they see how well the vehicles can navigate the measures.

- B. **Install or Modify Measure:** Following the temporary installation period, the neighborhood (NTCC and LTAC), the local government, and PennDOT (when necessary) must decide whether to install the measure on a permanent basis. At this point, they may also decide to modify the original traffic calming plan. (The modification need not take as long to develop as the original plan.)
- C. **Conduct Follow-up Studies:** Whether the measure is installed permanently at the onset or after a temporary installation, follow-up traffic studies should be conducted. Traffic data gathered after a permanent installation may aid the decision-making process on measures in other parts of the municipality, and can be used to justify additional traffic calming expenditures. In the event that resistance develops to the measure in question, follow-up studies may explain why.

Resistance to traffic calming measures may develop after they have been in-place for a number of months, or measures may prompt opposition among members of the community immediately after installation. If initial opposition occurs, it often passes over time and should not be acted upon unless safety is a concern. Some municipalities permit the removal of measures only after they have been in place for six months to a year, and then only with the same level of neighborhood support that was required to install the measure.

Depending on the particular traffic calming measure and project objective, the local government may monitor crashes, traffic speeds, traffic flow, or diversion to other routes. The following parameters may assist you in determining the benefits derived from the installation of traffic calming measures:

- ❑ Before and after crash statistics for motor vehicle crashes, motor vehicle/bicycle crashes, and motor vehicle/pedestrian crashes. The crash studies should indicate how crash trends in the project area have been affected and should cover a length of time sufficient to identify long-term effects.
 - ❑ Before and after speed studies to determine the 85th percentile speed. Ideally, speed studies should be performed upstream of, at, and downstream of the traffic calming measure to identify its effect on vehicle speeds.
 - ❑ Before and after user volume, including peak hour volumes, the average daily traffic (ADT), and the directional design hourly volume (DDHV). Traffic counts should be made on the street where traffic calming will be installed and on the streets to which traffic is expected to divert. The “after” counts should be made when traffic patterns have stabilized.
- D. **Modify Design or Remove Measure if Needed.** As previously indicated, the removal of traffic calming measures should only be considered after they have been in-place and monitored for six months to a year, and then only with the support of the neighborhood, unless a safety problem has developed.

If a safety problem develops, the local municipality should take steps to modify the traffic calming measure or remove it. PennDOT may also remove a traffic calming measure installed on a State road if a safety problem has developed. If PennDOT removes a measure from a State road due to safety concerns caused by improper installation or maintenance, the cost for removal must be reimbursed by the municipality.

A recent survey was conducted by PennDOT in which municipalities were questioned about the type of traffic calming policy adopted within the municipality. Based on the responses received, many municipalities have used the traffic calming study and approval process outlined above; however, municipalities have also implemented a more simplified and abbreviated version of the traffic calming policy. Traffic calming policies from various municipalities in Pennsylvania are provided in Appendix D. Also presented in Appendix D are two simpler versions of the traffic calming policy process that have been used in Pennsylvania.

A summary of the traffic calming survey is presented below, with additional survey details provided in Appendix B.

Statewide Pennsylvania Traffic Calming Survey

PennDOT requested the participation of local municipalities and townships for an online Traffic Calming survey. The survey was conducted to determine where traffic calming is being utilized within the municipality, whether before and after studies have been performed for specific devices, what policies have been adopted for requests for traffic calming devices and if the *Traffic Calming Handbook* was utilized.

Of the responses received, only sixteen (16) percent responded that they have implemented traffic calming devices within their municipality. The decision to install traffic calming devices within these municipalities were determined through traffic studies, public input, lowest cost/realistic alternatives, recommendations from municipal engineers, engineering consultants, PennDOT, and the board of commissioners or supervisors.

The most popular devices included on-street parking, curb extensions/bulbouts, speed humps, raised medians/pedestrian refuges, and right-in/right-out islands.

Further details of the statewide Pennsylvania traffic calming survey are provided in Appendix B.

Chapter 5

TRAFFIC CALMING MEASURES AND DESIGN GUIDELINES

Selecting Potential Traffic Calming Measures

The selection of traffic calming measures should be based on:

1. The measures potential to address volume or speed reduction on affected roadways.
2. The type of roadway.
3. Actual site conditions.

Specific measures have been grouped into four categories based upon the means by which they reduce volumes or speeds. The following is a description of the categories:

Horizontal Deflection – refers to two types of traffic calming measures. The first type hinders the driver's ability to drive in a straight line by creating a horizontal shift in the roadway. This shift forces drivers to slow their vehicles in order to safely navigate the measure. The second type of horizontal deflection measure is designed to narrow the width of the travel lane. Doing so reduces the usable surface of the roadway causing drivers to slow their vehicles to maintain an acceptable level of comfort. Although horizontal deflection measures are mainly used to address speed concerns, applications that narrow the travel lane can improve pedestrian safety by reducing the width of the crossing. Horizontal deflection measures may also have the secondary effect of reducing volumes; however, the effects will typically be minor.

Vertical Deflection – refers to traffic calming measures that create a change in the height of the roadway. When designed properly, vehicles must slow down over these measures in order to avoid unpleasant bumping sensations. As with horizontal deflection measures, vertical deflection measures are mainly used to reduce vehicle speeds, with only minor effects on traffic volumes. Vertical deflection measures can also be used to improve the safety of pedestrian crossings.

Physical Obstruction – refers to measures that prevent particular vehicle movements, thereby discouraging or eliminating cut-through traffic. The overall traffic volume reduction depends upon the nature of the traffic calming measure and the number of movements obstructed.

Signs and Pavement Markings – can be used as traffic calming measures that regulate traffic movements in lieu of physical changes to the roadway. In certain applications, these measures may produce the same effect as the physical traffic calming measures. However, police enforcement is often required to ensure motorist compliance.

Besides their primary function of reducing speeds or volumes, the large majority of measures also have the ability to reduce conflicts between vehicles and pedestrians, bicyclists, and other vehicles. In addition, well designed and landscaped traffic calming measures can enhance a neighborhood's appearance and the quality of life of its residents.

As stated in Chapter 2, traffic calming measures that are implemented to improve pedestrian safety, or have an effect on pedestrian travel, must be designed to meet the requirements set forth in the Americans with Disabilities Act. However, the diagrams of the traffic calming measures in this chapter are

not intended to represent actual site conditions or to depict the requirements set forth by the Americans with Disabilities Act.

Overview of Measures

The following is a list of commonly used traffic calming measures that are discussed in this chapter:

COMMONLY USED TRAFFIC CALMING MEASURES

Horizontal Deflection	
Curb extension / bulb-out	Areas of expanded curbing that extend across a parking lane and may narrow a travel lane.
Chicane	Series of 3 bulb-outs, staggered at mid-block locations on alternating sides of the street.
Gateway	Entrance treatment, typically using physical and textural changes, that provides identity to an area.
On-street parking	Provision of on-street parking that reduces roadway width.
Raised median island / pedestrian refuge	Narrow islands, at mid-block or intersections, between travel lanes with breaks in landscaping and curbing for pedestrians.
Traffic circle	Raised island in the center of an intersection that requires vehicles to travel counterclockwise around the circle.
Vertical Deflection	
Speed hump	Raised humps in the roadway, typically 3 inches high with a 12 or 22-foot travel length.
Speed Cushion	Series of three to four cushions spaced across the roadway width that permits wide axle emergency vehicles to pass without slowing down.
Raised crosswalk	Marked pedestrian crossings elevated 3 to 6 inches above street grade at intersections or mid-block.
Raised intersection	Intersections, including crosswalks, raised 3 to 6 inches above street grade.
Physical Obstruction	
Semi-diverter	Directional closure created by physically blocking half the street.
Diagonal diverter	Physical barrier placed diagonally across a four-way intersection to create two unconnected intersections.
Right-in / right-out island	The use of raised islands to prevent left turns and through movements, to and from side streets, at intersections with major streets.
Raised median through intersection	Median barrier through an intersection that discourages through traffic in a residential area by restricting movements.
Street closure	The use of a cul-de-sac to close a roadway by extending a physical barrier across the entire width, obstructing all traffic movements.

Figure 3 depicts the effectiveness of each traffic calming measure in addressing volume and speeding problems. The actual effectiveness of any traffic calming device is unique to the application and the location. However many municipalities are interested in the potential reductions in speed and volume for various devices prior to implementation. Appendix D provides case studies that provide actual data on the expected impacts. In addition the aforementioned ITE reference provides additional data on the effectiveness of devices. The effects on traffic conflicts (between vehicles and pedestrians, bicyclists, and other vehicles) and emergency services are also summarized.

**FIGURE 3
EFFECTS OF TRAFFIC CALMING MEASURES**

	Volume Reduction	Speed Reduction	Conflict Reduction	Emergency Response
Horizontal Deflection				
Bulb-out / curb extension	<input type="checkbox"/>	<input checked="" type="checkbox"/>	<input checked="" type="checkbox"/>	<input type="checkbox"/>
Chicane	<input checked="" type="checkbox"/>	<input checked="" type="checkbox"/>	<input type="checkbox"/>	<input checked="" type="checkbox"/>
Gateway	<input type="checkbox"/>	<input checked="" type="checkbox"/>	<input type="checkbox"/>	<input type="checkbox"/>
On-street parking	<input type="checkbox"/>	<input checked="" type="checkbox"/>	<input type="checkbox"/>	<input checked="" type="checkbox"/>
Raised median island / pedestrian refuge	<input type="checkbox"/>	<input checked="" type="checkbox"/>	<input checked="" type="checkbox"/>	<input type="checkbox"/>
Traffic circle	<input checked="" type="checkbox"/>	<input checked="" type="checkbox"/>	<input checked="" type="checkbox"/>	<input checked="" type="checkbox"/>
Vertical Deflection				
Speed hump	<input checked="" type="checkbox"/>	<input checked="" type="checkbox"/>	<input checked="" type="checkbox"/>	<input checked="" type="checkbox"/>
Speed Cushion	<input checked="" type="checkbox"/>	<input checked="" type="checkbox"/>	<input checked="" type="checkbox"/>	<input type="checkbox"/>
Raised crosswalk	<input checked="" type="checkbox"/>	<input checked="" type="checkbox"/>	<input checked="" type="checkbox"/>	<input checked="" type="checkbox"/>
Raised intersection	<input type="checkbox"/>	<input checked="" type="checkbox"/>	<input checked="" type="checkbox"/>	<input checked="" type="checkbox"/>
Physical Obstruction				
Semi-diverter	<input checked="" type="checkbox"/>	<input checked="" type="checkbox"/>	<input checked="" type="checkbox"/>	<input checked="" type="checkbox"/>
Diagonal diverter	<input checked="" type="checkbox"/>	<input checked="" type="checkbox"/>	<input checked="" type="checkbox"/>	<input checked="" type="checkbox"/>
Right-in / right-out island	<input checked="" type="checkbox"/>	<input type="checkbox"/>	<input checked="" type="checkbox"/>	<input checked="" type="checkbox"/>
Raised median through intersection	<input checked="" type="checkbox"/>	<input type="checkbox"/>	<input checked="" type="checkbox"/>	<input checked="" type="checkbox"/>
Street closure	<input checked="" type="checkbox"/>	<input checked="" type="checkbox"/>	<input checked="" type="checkbox"/>	<input checked="" type="checkbox"/>
Signing and Pavement Markings				
Speed limit signing	<input type="checkbox"/>	<input checked="" type="checkbox"/>	<input type="checkbox"/>	<input type="checkbox"/>
Multi-way stop control	<input type="checkbox"/>	<input checked="" type="checkbox"/>	<input checked="" type="checkbox"/>	<input checked="" type="checkbox"/>
Turn prohibitions	<input checked="" type="checkbox"/>	<input type="checkbox"/>	<input checked="" type="checkbox"/>	<input type="checkbox"/>
One-way streets	<input checked="" type="checkbox"/>	<input type="checkbox"/>	<input checked="" type="checkbox"/>	<input checked="" type="checkbox"/>
Commercial vehicle prohibitions	<input checked="" type="checkbox"/>	<input checked="" type="checkbox"/>	<input type="checkbox"/>	<input type="checkbox"/>
Roadway narrowing with edge lines	<input type="checkbox"/>	<input checked="" type="checkbox"/>	<input type="checkbox"/>	<input type="checkbox"/>
Transverse markings	<input type="checkbox"/>	<input checked="" type="checkbox"/>	<input type="checkbox"/>	<input type="checkbox"/>

- Minimal or no effect
- Moderate effect
- Significant effect

The following information provides a description of each measure, its usage, and its effect on speeds and traffic volumes. The advantages of each measure, disadvantages, cost, and other considerations are also presented. The majority of traffic calming measures used today do not have specific design criteria. For this reason, each jurisdiction across the country has modified measures to suit their particular

applications. If established design criteria are available or if specific design requirements are recommended by PennDOT, the information is provided. The following depictions are not drawn to scale and are not intended to represent actual site conditions. Information about the application of traditional traffic control devices, such as signing and pavement markings, for use as traffic calming measures is included in Chapter 6. All signing and pavement markings should utilize the latest applicable standards and manuals.

CURB EXTENSIONS / BULB-OUTS

Description:

Curb extensions, sometimes referred to as bulb-outs, are areas of expanded curbing.

Appropriate Locations:

- ❑ Appropriate for all street classifications: local roads, collectors, and arterials.
- ❑ Many jurisdictions extend the curb only 6 feet from the existing curb, which protects parked vehicles, improves pedestrian visibility, and minimizes crossing distance, but does not typically affect the speed of motorists. For extensions that do not result in narrowing of the travel lanes, usage on streets of up to 15,000 ADT with posted speeds up to 40 mph is appropriate.
- ❑ Works well in downtown areas.
- ❑ Primarily used at intersections.
- ❑ Can be used at mid-block locations with significant pedestrian activity, school children, or senior citizens. Mid-block curb extensions may also be used to address speeding on streets where speed humps are not permitted.

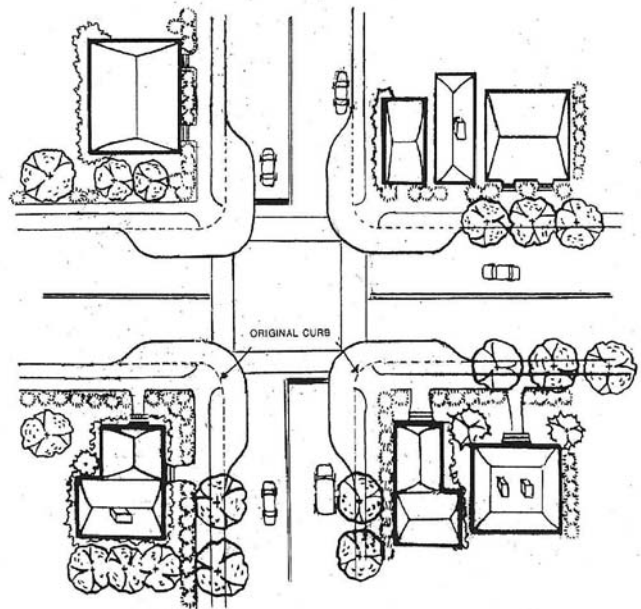

Typical Uses:

- ❑ Reduce the crossing distance for pedestrians.
- ❑ Improve the line-of-sight for pedestrians.
- ❑ Make pedestrians more visible to oncoming traffic.
- ❑ Slow traffic by funneling it through a narrower street opening.
- ❑ Slow vehicles making a right turn by reducing the curb radius.

Speed/Volume Reductions:

- ❑ Most curb extensions result in speed reductions of 1-2 mph.
- ❑ Potential to reduce speeds by up to 5 mph when significantly narrowing the travel lanes. For example, some jurisdictions use extensions to briefly narrow two travel lanes to a total width of 18 feet. (This width is not recommended for arterials or high-volume collectors.)

Approximate Cost:

- ❑ Each pair may cost \$7,000 to \$10,000. Mid-block measures may cost less (\$4,000) if they are smaller.

Signing and Markings:

- ❑ Signing or pavement markings may be needed, especially when installed at a mid-block location (see Figure on Page 28).
- ❑ All signing and pavement markings should utilize the latest applicable standards and manuals.

Other Considerations:

- ❑ Impact on roadway drainage must be addressed. Drainage may be provided by devices such as catch basins, concrete channels, valley gutters, inlets, and trench drains. Ponding on the sidewalk may also occur if the measure is not properly designed.
- ❑ Vertical curb is recommended, but mountable curb can be used if necessary to accommodate turning trucks and buses.
- ❑ Mid-block curb extensions should be combined with crosswalks whenever possible.
- ❑ Provisions should be made for snow and ice removal.

<p>Advantages:</p> <ul style="list-style-type: none"> ❑ Improve pedestrian safety. ❑ May reduce travel speed. ❑ May slow right-turning vehicles. ❑ Prevent illegal parking close to intersections. ❑ Facilitate pedestrian access directly to transit vehicles without entering street. ❑ Can improve neighborhood appearance with landscaping and/or textured treatments. 	<p>Disadvantages:</p> <ul style="list-style-type: none"> ❑ Can result in loss of one on-street parking space on each side of the road, though at intersections this is unlikely given statutory prohibitions of parking close to intersections. ❑ May prevent right turns at intersection when another vehicle is stopped at the stop line. ❑ May make it difficult to accommodate full bicycle lanes. ❑ Snow Removal
---	--

Curb Extensions/Bulb-Outs

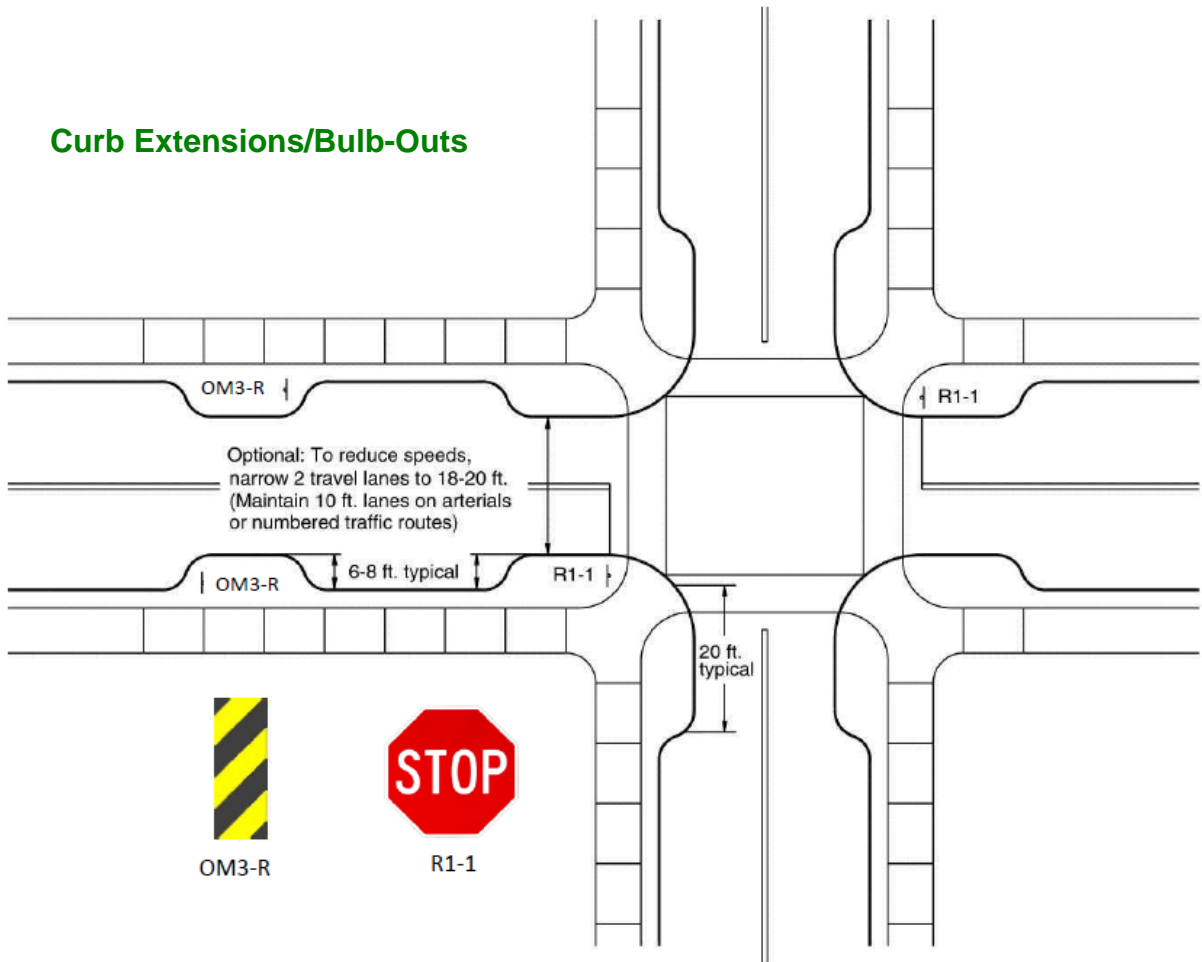

Note: All signing and pavement markings should utilize the latest applicable standards and manuals.

CHICANES

Description:

A chicane is a series of three curb extensions staggered on alternating sides of the street, at a mid-block location, which forces vehicles to negotiate the narrowed roadway in a snake-like fashion.

Appropriate Locations:

- ❑ Most appropriate on local streets which have volumes less than 3,500 vehicles per day.
- ❑ Appropriate on two-lane, two-way streets, or on one-lane, one-way streets.

Typical Uses:

- ❑ Slow vehicles by forcing motorists to weave through the extensions.

Speed/Volume Reductions:

- ❑ Can reduce vehicle speeds inside the measures by 5 to 13 mph, and in the vicinity of the measures by 1 to 6 mph.
- ❑ Chicanes may reduce traffic volumes by as much as 20 percent.

Approximate Cost:

- ❑ Chicanes may cost as much as \$14,000 when the existing curb is removed and new curbing is poured in-place. Chicanes cost approximately \$6,000 where the existing curb is kept and new curb is pre-cast.
- ❑ Pavement markings and flexible delineator posts can be used as temporary measures. The cost for this temporary application is around \$1,000.

Signing and Markings:

- ❑ The “Left Winding Road Sign” (W1-5L) with an appropriate “Advisory Speed Sign” (W13-1) should be used at least 150 feet in advance of the chicane. Reflectors, street lighting, and elevated landscaping are also recommended to improve visibility.
- ❑ All signing and pavement markings should utilize the latest applicable standards and manuals.

Other Considerations:

- ❑ Traffic volumes should be balanced in each direction. Chicanes lose effectiveness when volumes are significantly unbalanced.
- ❑ Chicanes may not be appropriate in areas with high truck traffic.

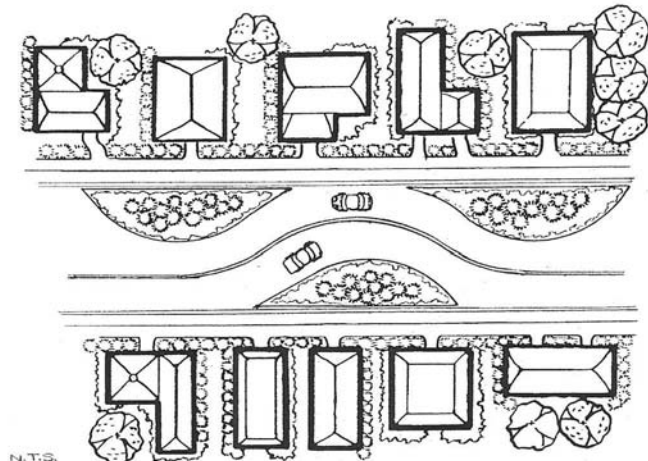

- ❑ Depending upon the width of the roadway, it may be necessary to ban parking within the chicane.
- ❑ Avoid locations where grades exceed 8 percent.
- ❑ Placement of chicanes will depend on site conditions such as driveway locations.
- ❑ Devices used to construct chicanes typically include curb extensions, planters, trees, barrels, fences or barricades. Care must be taken to ensure that these devices do not create a safety hazard through the introduction of fixed objects on or along the roadway.

<p>Advantages:</p> <ul style="list-style-type: none"> ❑ Reduce vehicle speeds. ❑ Reduce traffic volumes. ❑ May reduce collisions. ❑ Traffic noise may be reduced due to lower speeds and volume. ❑ Landscaped chicanes improve street appearance. ❑ The Insurance Corporation of British Columbia, summarizing 43 international studies, concluded that chicanes were effective in reducing the number of collisions. 	<p>Disadvantages:</p> <ul style="list-style-type: none"> ❑ With two-lane chicanes, motorists may attempt to increase travel speeds by crossing the centerline to maintain a straight line of travel. ❑ Will require loss of on-street parking spaces. ❑ Snow removal. ❑ Hinders heavy truck operation.
--	---

Chicane

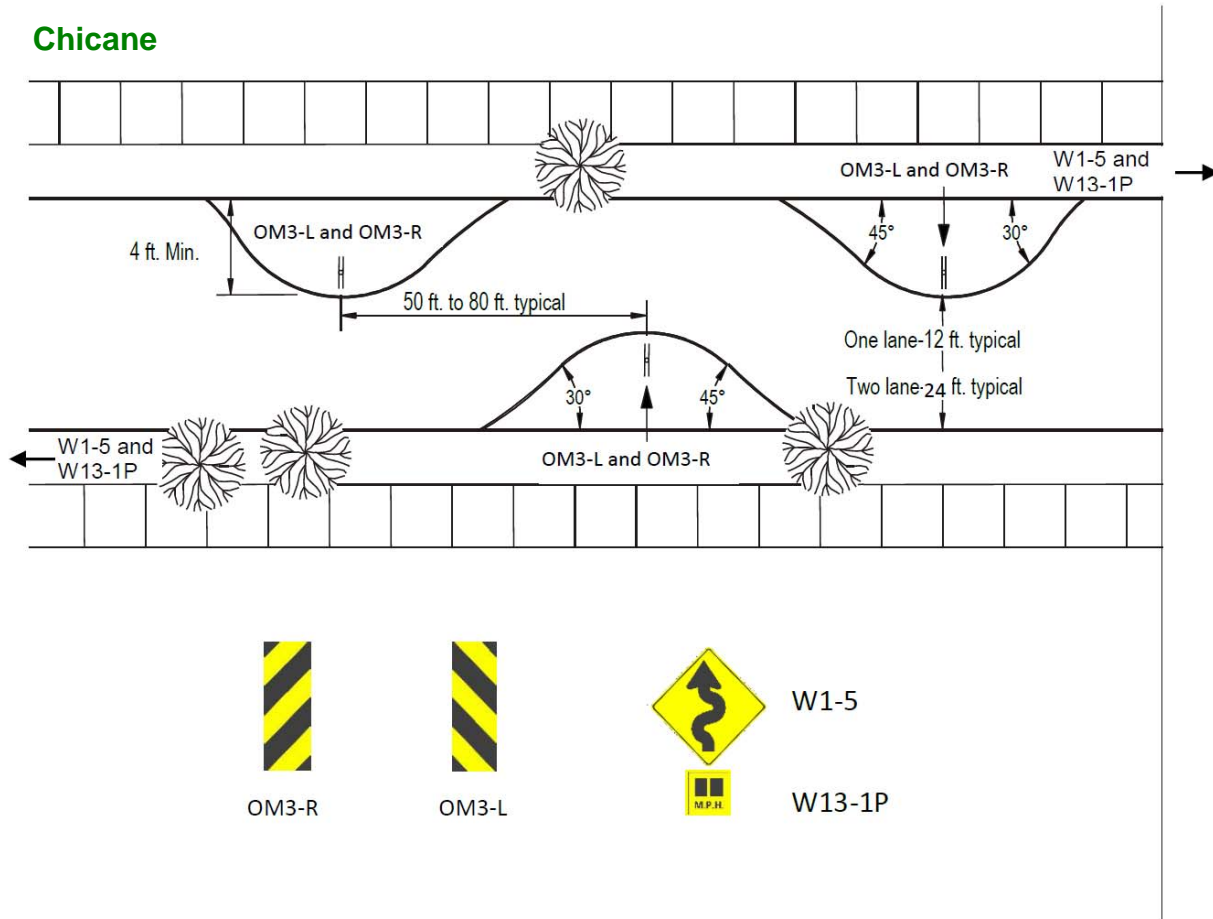

Note: All signing and pavement markings should utilize the latest applicable standards and manuals.

GATEWAYS

Description:

Gateways are special entrance treatments that provide identity to a neighborhood by using a combination of physical and textural changes.

Appropriate Locations:

- ❑ Local roads only.
- ❑ Entrance to a residential community.

Speed/Volume Reductions:

- ❑ May reduce entry speed, depending on the inclusion of other measures such as bulb-outs and planted median islands.

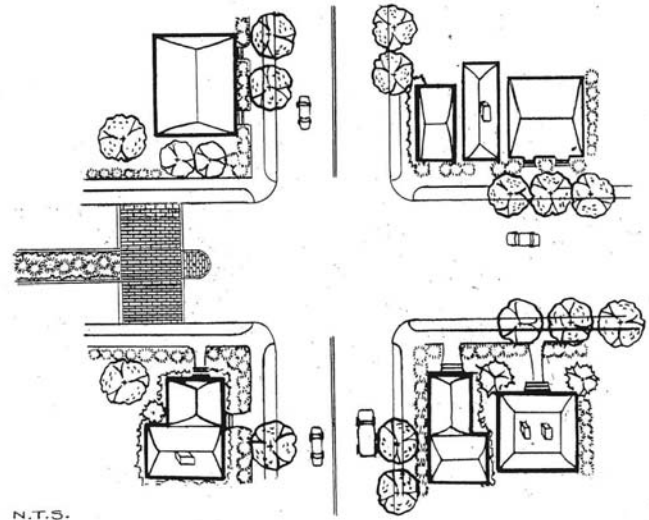

Approximate Cost:

- ❑ Cost varies widely (\$5,000 to \$20,000) depending on the design and extent of physical elements used.

Other Considerations:

- ❑ Entrance treatments alone (landscaping, signing, pavement treatments) do not reduce speeds or total volumes, unless combined with other physical measures. They are, however, thought to increase driver awareness of the environment in which they are driving.
- ❑ A number of traffic calming measures such as bulb-outs at the intersection, textured pavement treatments, and median islands may be included in a gateway design. The exact configuration of a gateway will vary based on the location of the gateway, available funding, and any conflicts such as driveways.
- ❑ Landscaped median islands may be added at the intersection to slow turning movements and visually enhance the street.
- ❑ Provisions should be made for snow and ice removal.

Advantages:

- ❑ Help identify neighborhood.
- ❑ Create added streetscape area for landscaping.
- ❑ Can discourage truck entry, depending on the extent of narrowing and inclusion of median islands at the intersection.
- ❑ Emphasize a change in environment from an arterial to a residential street.
- ❑ Reduce vehicle speeds.

Disadvantages:

- ❑ If textured pavements are used, some noise will result.

ON-STREET PARKING

Description:

Parking on one or both sides of the roadway which has the effect of reducing the roadway width. By law, on-street parking is permitted unless otherwise prohibited.

Appropriate Locations:

- ❑ On-street parking may be appropriate for all classifications of streets.

Typical Uses:

- ❑ Reduce vehicle speeds by reducing the effective width of the roadway.

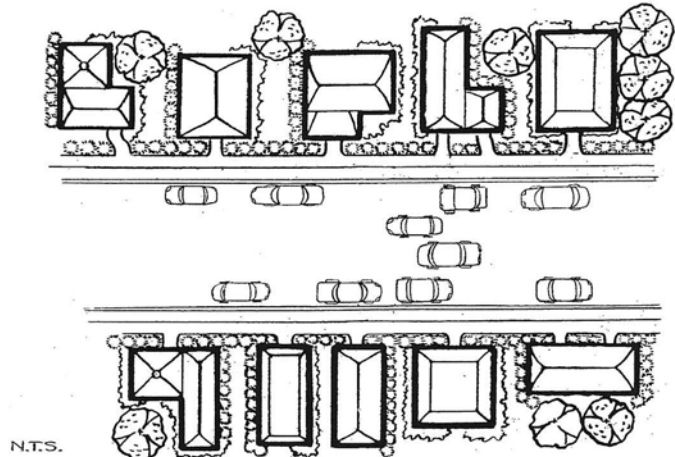

Speed/Volume Reductions:

- ❑ The most pronounced effect on speed occurs on narrow two-way streets with parking on both sides. If parking is sufficiently occupied, and street width is less than 30 feet, there is a “chicane” effect as vehicles may occasionally have to pull over to permit opposing vehicles to pass. Creating this chicane effect is appropriate only on local streets. Even for streets wider than 30 feet, on-street parking may serve to reduce speeds slightly by narrowing the effective roadway width.

Approximate Cost:

- ❑ If landscaped islands are created to protect parking, the cost can reach \$5,000 or more per island.

Other Considerations:

- ❑ On-street parking can be protected by a landscaped island that projects out from the curb.
- ❑ Angle parking has the potential to cause more crashes than parallel parking, and is generally not recommended to achieve speed reduction.
- ❑ If half or more of the block face is not parked out, on-street parking is not likely to result in reduced travel speeds.

<p>Advantages:</p> <ul style="list-style-type: none"> ❑ May reduce travel speeds, depending on extent of use of on-street parking. ❑ Parked vehicles provide a buffer between traffic and pedestrians on sidewalks. This provides a comfort level for pedestrians that can be particularly important in downtown commercial areas. 	<p>Disadvantages:</p> <ul style="list-style-type: none"> ❑ On-street parking can reduce the visibility of pedestrians and vehicles to each other. ❑ Increased risk of suddenly opened doors hitting cyclists where the adjacent travel lane is narrow.
---	---

TRAFFIC CIRCLES

Description:

Traffic circles are raised islands located in the center of an unsignalized intersection. All traffic must negotiate the circle and circulate in a counterclockwise direction. When yield signs are used on each approach, traffic must yield to vehicles within the circle.

Appropriate Locations:

- ❑ Traffic circles are appropriate at intersections of local streets without high pedestrian or left-turning volumes.
- ❑ The ADT volumes on each local street should not exceed 3,500.

Typical Uses:

- ❑ Slows vehicles due to the horizontal deflection, and through the motorist ability to break up line of sight (when appropriately landscaped).

Speed/Volume Reductions:

- ❑ Circles are most effective in reducing speeds when several are used in a series.
- ❑ On average, speeds are reduced from 4 to 6 mph in the vicinity of circles.
- ❑ Circles normally have only a slight effect on reducing volumes, although some jurisdictions report reductions of 10 to 20 percent.

Approximate Cost:

- ❑ Traffic circles that fit within existing curbs, gutters, and drains, and have no irrigation for landscaping, cost \$3,000 to \$8,000. Costs will increase if right-of-way needs to be acquired or utilities need to be relocated. More complicated installations may cost \$20,000+.
- ❑ Landscaping costs have the potential to add significantly to the ongoing maintenance costs. Landscaping maintenance can often be delegated to the neighborhood association or to residents who have been supportive of the installation.

Other Considerations:

- ❑ Depending on the intersection configuration, the shape of the traffic circle may not actually be round.
- ❑ Turning analysis should be completed to ensure that the design vehicle can negotiate the circle. A mountable concrete apron, 2 to 4 feet wide, may be used to accommodate emergency service vehicles, trucks, and buses.
- ❑ PennDOT Publication "Guide to Roundabouts", Pub. 414 should be utilized.

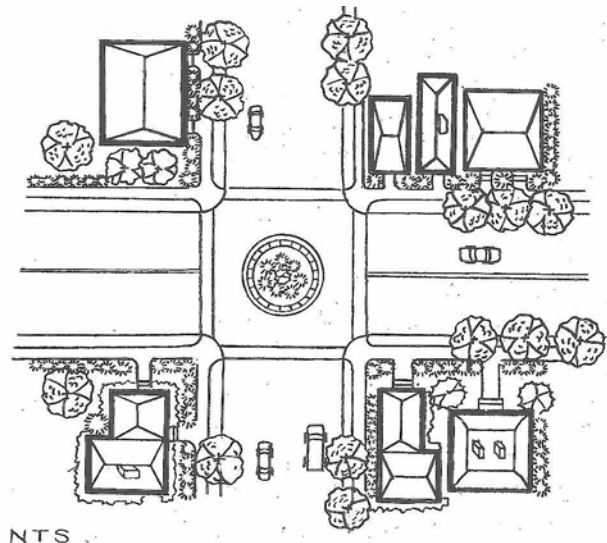

- ❑ Drainage works best if the cross-section slopes away from the circle, despite the fact that this creates a reverse super elevation.
- ❑ It may be necessary to move crosswalks further away from the traffic circle to prevent vehicles from encroaching on the crosswalk.
- ❑ Traffic circles may require additional street lighting.
- ❑ Provisions should be made for snow and ice removal.

Signing and Markings:

- ❑ The use of the “Circular Intersection Sign” (W2-6) with an appropriate “Advisory Speed Sign” (W13-1P) is recommended in advance of the first traffic circle encountered on each street.
- ❑ All signing and pavement markings should utilize the latest applicable standards and manuals.

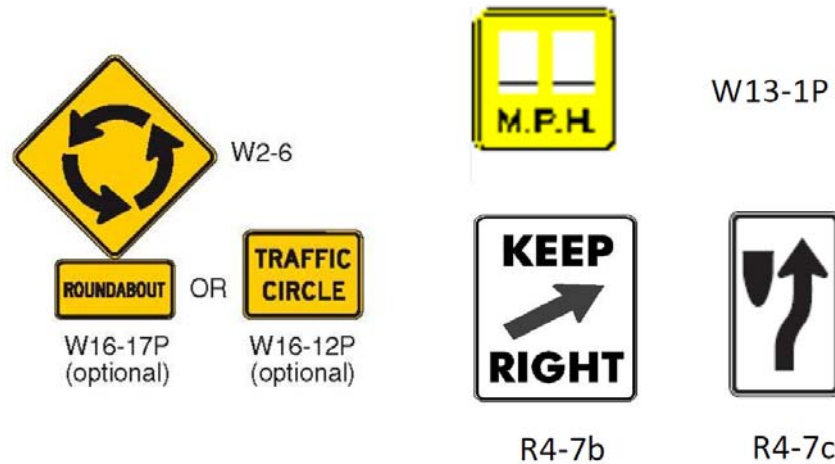

Advantages:

- ❑ Reduce speeds.
- ❑ Can significantly reduce motor vehicle collisions, particularly right-angle conflicts.
- ❑ Reduces the number of potential conflict points at an intersection.
- ❑ Enhances neighborhood appearance when properly landscaped.
- ❑ The Insurance Corporation of British Columbia, summarizing 43 international studies, reported that circles reduce collisions by 82 percent.

Disadvantages:

- ❑ May make it difficult for emergency vehicles, buses, and trucks to turn left.
- ❑ May be inappropriate on major emergency response routes. Emergency service vehicles are delayed from 1 to 11 seconds per circle, with most delays falling around 5 to 8 seconds.
- ❑ May require removal of some on-street parking. The prohibition of parking for 30 feet from the intersection is recommended.

The following traffic circle design drawings, from the City of Seattle's Neighborhood Traffic Calming Program, are provided as a reference. They relate the critical dimensions that should be considered when designing an effective traffic circle.

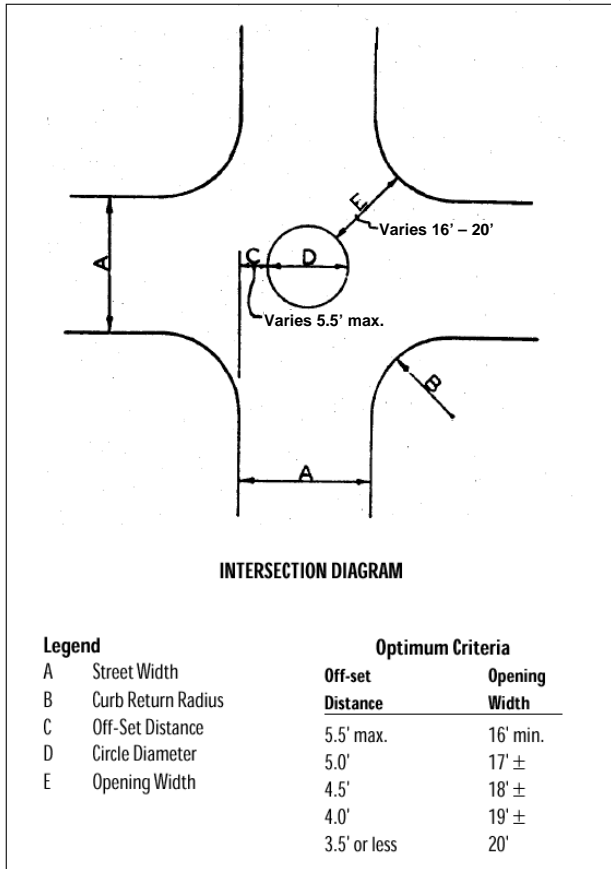

(Source: City of Seattle, Washington)

Street Width (feet)	Corner Radius (feet)	Circle Diameter (feet)
24	<12	Reconstruct curbs
	12	13
	15	14
	20	15
	25	17
30	10	19
	12	20
	15	20
	20	22
	25	24
36	10	26
	12	26
	15	27
	18	28
	20	29
	25	33

(Source: City of Seattle, Washington)

ROUNDBABOUTS

Description:

Roundabouts are measures similar to traffic circles, but they must have all of the following characteristics:

- ❑ Yield control is used on all entries and the circulatory roadway has no control.
- ❑ Circulating vehicles have the right-of-way.
- ❑ Pedestrian access is allowed only across the legs of the roundabout, behind the yield line.
- ❑ No parking is allowed within the circulatory roadway or at the entries.
- ❑ All vehicles circulate counter-clockwise and pass to the right of the central island.

If any of the roundabout characteristics are not met, the circular intersection is considered a traffic circle.

For information on PennDOT design, signing and striping standards for roundabouts, along with other information, go to PennDOT publication 414 (Guide to Roundabouts).

The following pictures depict the differences between a traffic circle and a roundabout.

Traffic Circle

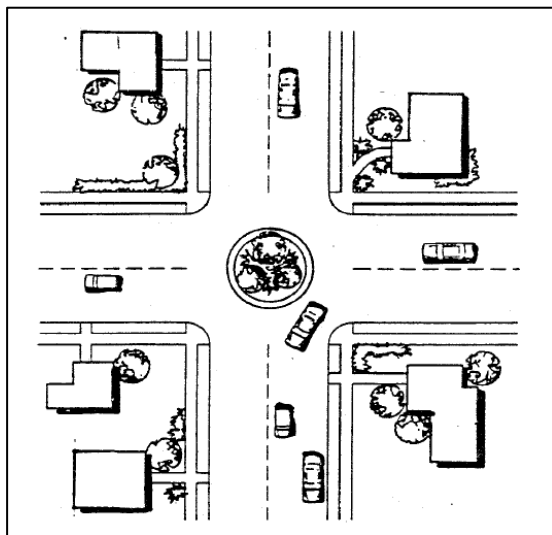

Source: Institute of Transportation Engineers' Traffic Calming – State of the Practice

Roundabout

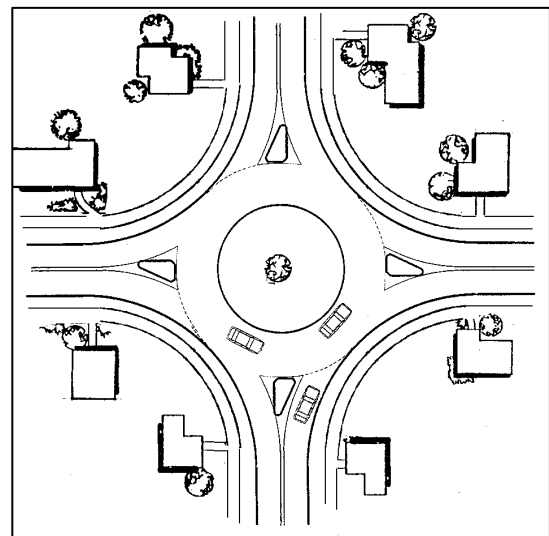

Source: Institute of Transportation Engineers' Traffic Calming – State of the Practice

SPEED HUMPS

Description:

A speed hump is a raised surface on the roadway that is typically 3 to 4 inches in height, and 12 to 20 feet in length. Speed humps are by far the most popular traffic calming measure in the United States, likely because they are effective in reducing speeds at minimal cost.

Common Designs:

- ❑ The Watts speed hump (designed by the Transport and Road Research Laboratory in Great Britain) is a parabolic hump 12 feet in length. This model was endorsed by ITE in *Guidelines for the Design and Application of Speed Humps*.
- ❑ The Seminole County speed hump is the most popular alternative to the Watts hump. Designed by Seminole County, Florida, this hump is 22 feet in length with 6-foot ramps on either end of a 10-foot flat top. This type of speed hump design is also referred to as a “speed table”.

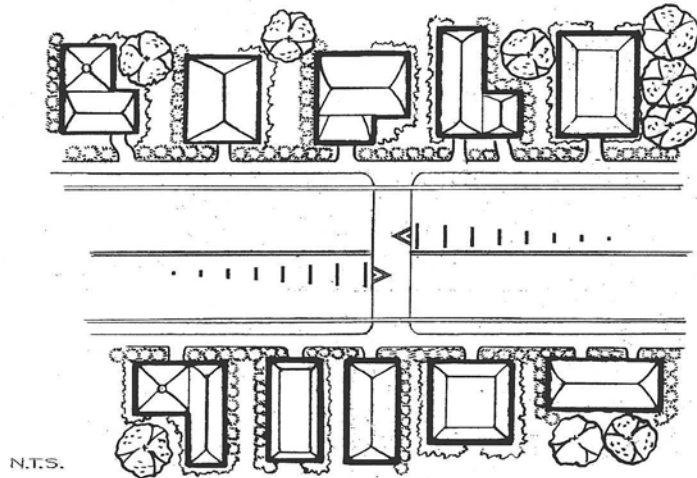

Appropriate Locations:

- ❑ Both humps are appropriate for use on Pennsylvania roads. However, due to their different profiles, they are effectively employed in different settings.
- ❑ The Watts hump is recommended only for local streets with volumes less than 3,500 ADT and posted speeds of 30 mph or less. In addition, it is not recommended for major emergency service routes.
- ❑ The Seminole County hump can be used in a greater variety of situations. This type of hump can be used on collector roads as well as local roads. It is appropriate for streets with volumes up to 6,500 ADT. Many jurisdictions also permit the use of Seminole speed humps on emergency response routes.
- ❑ Primarily used at mid-block locations.
- ❑ Similar designs can be used as raised pedestrian crosswalks.

Typical Uses:

- ❑ Within typical residential travel speeds, humps create a gentle rocking motion encouraging motorists to slow to a safe speed at or below the speed limit.
- ❑ In Pennsylvania, the Watts speed hump is typically used.

Speed/Volume Reductions:

- ❑ The design speed is determined by the dimensions of the speed hump.

- ❑ The Watts hump is designed to slow vehicles to 15 to 20 mph at each hump and 25 to 30 mph in between properly spaced humps (see “Other Considerations”). Numerous studies have demonstrated that Watts humps can reduce speeds by about 8 mph in the vicinity of humps. Volumes are reduced, on the average, by about 18 percent.
- ❑ Because of its gentler profile, the Seminole County hump has a design speed of 25 to 30 mph at the hump, and approximately 35 mph in between humps. It has been shown to reduce speeds by about 6.5 mph and volumes by 12 percent. Some jurisdictions have found that speed of motorists at the hump and in-between the humps are not significantly different.

Approximate Cost:

- ❑ Each speed hump installation costs about \$1,500 to \$3,500, depending on roadway width.

Other Speed Hump Designs:

- ❑ The Gwinnett County speed hump, like the Seminole County hump, is 22 feet in length with 6-foot ramps and a 10-foot plateau. However, the ramps of the Gwinnett speed hump are straight, not parabolic. This type of hump can be used in situations similar to the Seminole County hump.
- ❑ The 14-foot speed hump was developed by Portland, Oregon after it concluded that the 12-foot hump was too abrupt. Its effect on speeds and volumes is similar to the Watts hump and is also designed for use only on local streets.
- ❑ The Offset/Split speed hump, also designed by Portland, Oregon, is used for the benefit of emergency vehicles. Two 22-foot speed humps on opposing sides of the roadway are placed at least 50 feet apart. Small concrete medians are placed 10 to 15 feet in advance of each “hump half.” Pavement striping and raised markings give the illusion that the median continues through. Emergency vehicles can avoid the speed hump by following a chicane pattern around the humps.



Split Speed Hump
Source: City of Portland, Oregon

Advantages of offset/split speed humps include:

- Reduced travel time for emergency response vehicles; and
- They may be utilized on primary emergency response routes.

Disadvantages of offset/split speed humps include:

- A minimum roadway width of approximately 40-feet, curb-to-curb, is required to allow spaces for the serpentine path of emergency response vehicles; and
- On-street parking would be prohibited within the vicinity of offset speed humps.

Signing and Markings:

- A Speed Hump Warning Sign (MUTCD W17-1) has been incorporated in the Manual on Uniform Traffic Control Devices. This sign has also been included in PennDOT's Publication 236 (W17-1). It is recommended that this sign be installed either 100 feet in advance of speed humps, at the hump, or in both locations. Where multiple humps exist on one street, one sign before the first hump encountered, labeled "SPEED HUMPS," may be sufficient. It is also recommended that the "Speed Hump" sign be accompanied by an "Advisory Speed Plaque" (W13-1P). However, if there are a series of speed humps in close proximity, an advisory speed plaque may be eliminated on all but the first speed hump sign in the series. The indicated speed depends upon the design of the individual speed hump.



W17-1



W13-1P

- The pavement marking designs on the following pages are provided in the Manual on Uniform Traffic Control Devices. It is recommended that one of these sets of markings be used with speed hump designs.
- All signing and pavement markings should utilize the latest applicable standards and manuals.

Detail – Advance Warning Markings for Speed Humps

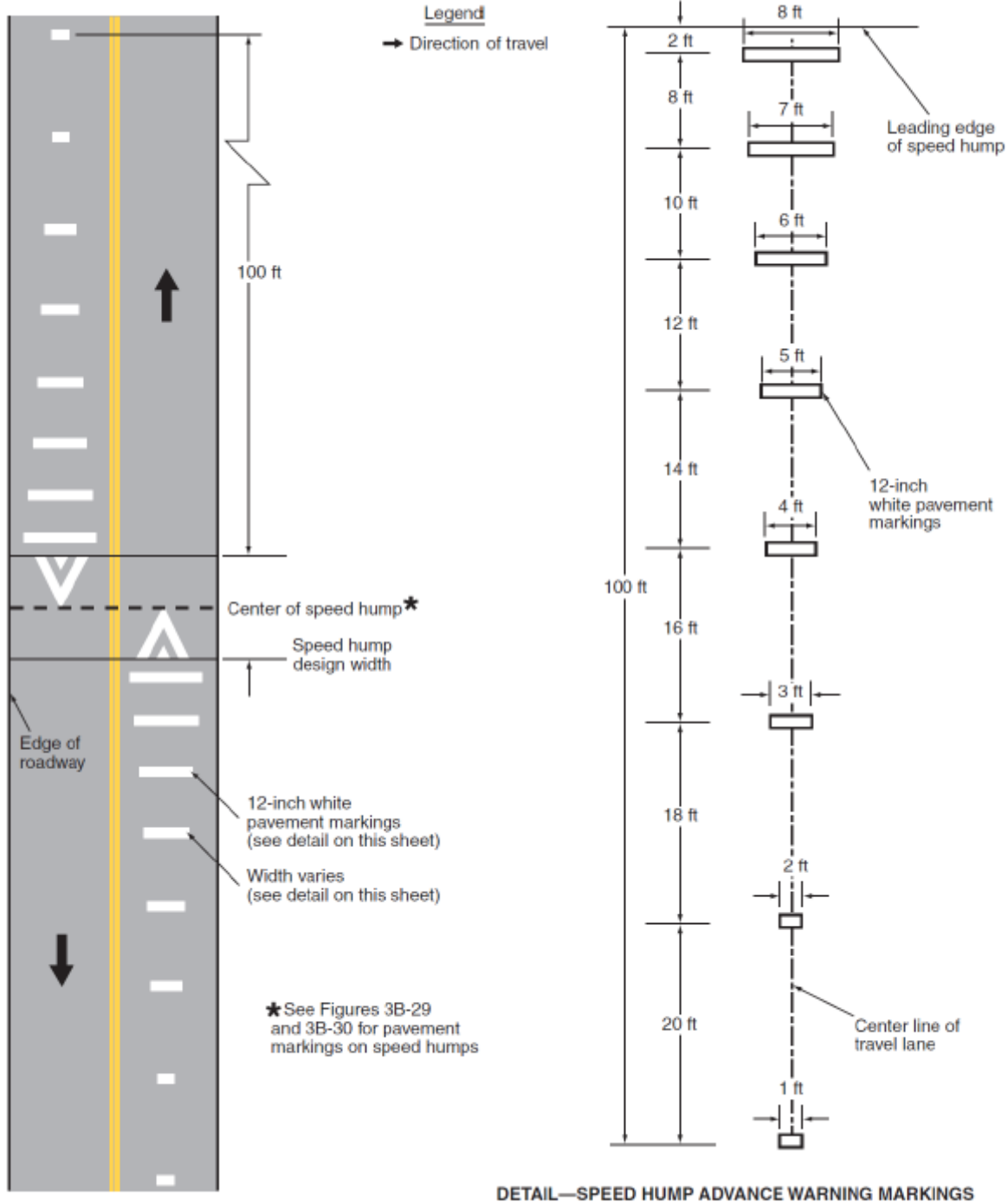

Note: All signing and pavement markings should utilize the latest applicable standards and manuals.

Pavement Markings for Speed Humps without Crosswalks

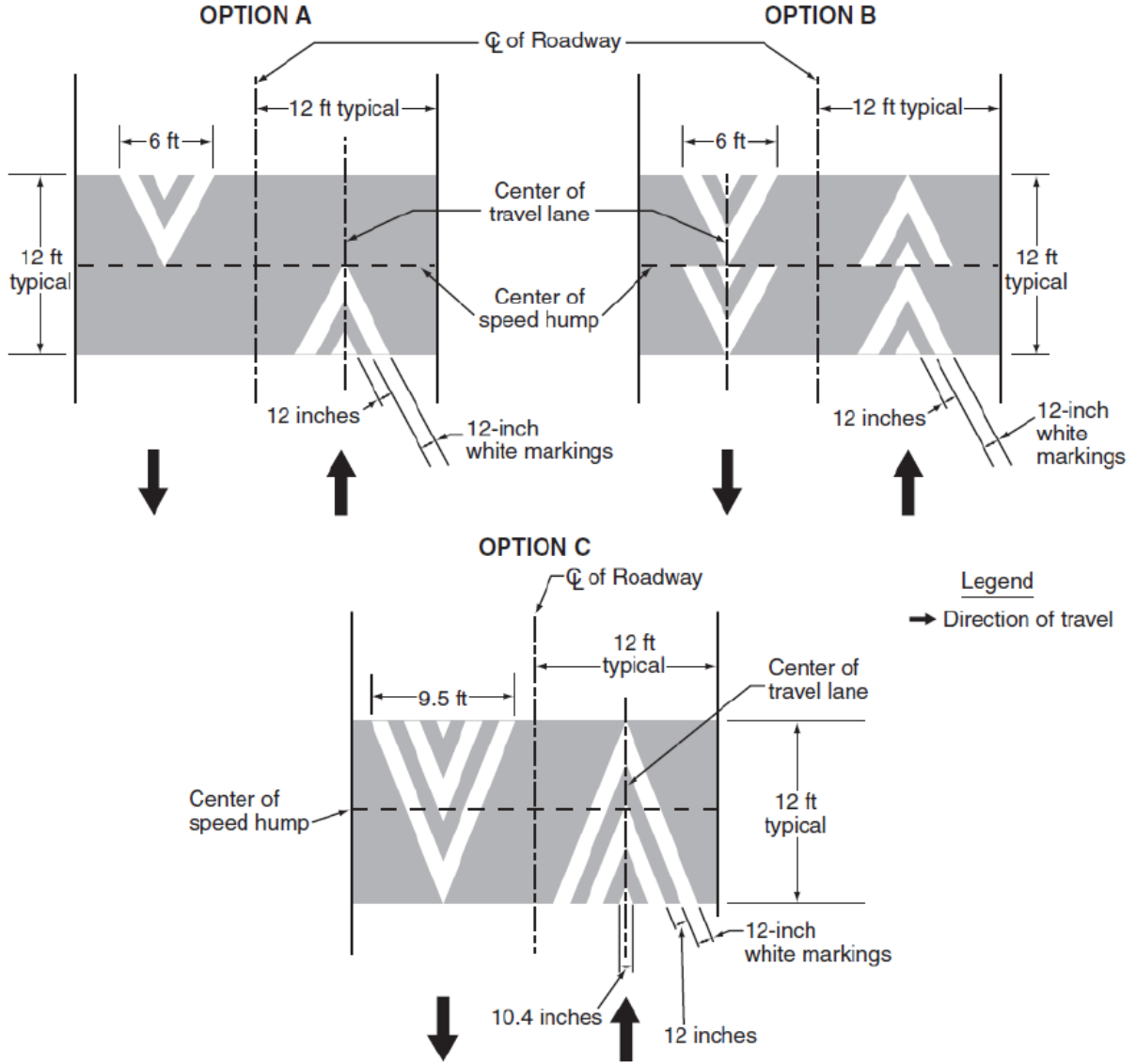

Note: All signing and pavement markings should utilize the latest applicable standards and manuals.

Pavement Markings for Speed Tables or Speed Humps with Crosswalks

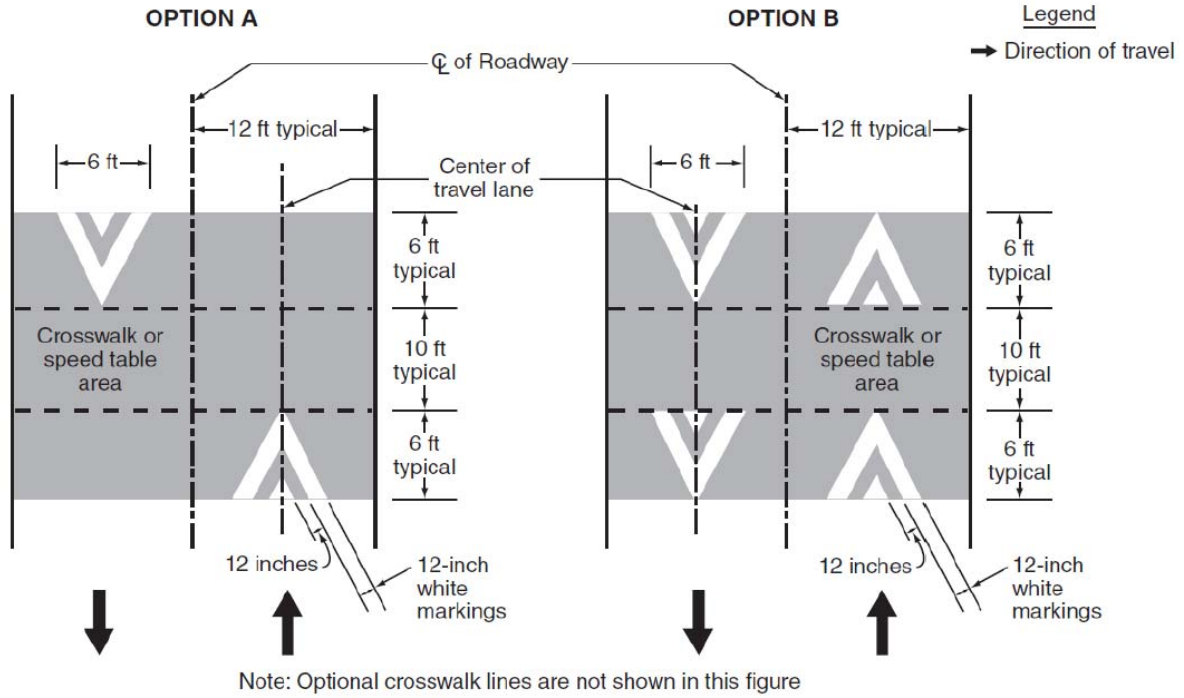

Note: All signing and pavement markings should utilize the latest applicable standards and manuals.

Other Considerations:

- ❑ Humps should be placed 250 to 600 feet apart. One study showed that placing Watts speed humps at intervals of 275 feet resulted in 85th percentile speeds of 25 mph; intervals of 550 feet resulted in 85th percentile speeds of 30 mph.
- ❑ Normally, no hump should be placed within 150 feet of an unsignalized intersection or 250 feet of a signalized intersection.
- ❑ Speed humps should not be used on curves unless the radius is greater than 300 feet.
- ❑ Humps should not be installed on streets with a grade exceeding 8%.
- ❑ Humps should not be installed on streets without curbing unless obstructions such as signing, flexible delineator posts, or bollards prevent drivers from driving around the hump. Rocks, boulders, and other objects of this nature should not be used for this application.
- ❑ Ideally, speed humps should extend across the roadway from curb to curb. This design is generally preferred by bicyclists, and it prevents motorists from driving with one wheel in the gutter (this may happen with tapered edges). If drainage cannot be accommodated under curb-to-curb conditions, it is recommended that humps end before bike lanes or continue across the bike lane without tapering off.
- ❑ Watts humps delay emergency vehicles anywhere from 1 to 10 seconds, with most delays in the range of 3 to 7 seconds.
- ❑ Seminole County humps appear to reduce the delay for most types of emergency vehicles by approximately 1 second. Emergency service companies greatly prefer Seminole County humps to Watts humps both because they reduce delay, and because they are less jarring to the long, stiff-bodied emergency service vehicles.
- ❑ Humps usually have a parabolic cross section. A sinusoidal cross section is harder to construct but may better facilitate snow removal.
- ❑ Speed humps have been found to be more effective in reducing speeds, but speed tables are easier to construct and generally more acceptable to the traveling public.
- ❑ Although speed humps may create noise from vehicles passing over them, the overall noise levels on the street may be reduced due to lower vehicle speeds.
- ❑ Traffic may divert to other parallel streets that are not traffic calmed.
- ❑ In areas with snow removal problems, a measure such as a flexible delineator post may be needed at each hump to alert snowplow operators to lift their blades.

Speed humps should be distinguished from speed *bumps*, which may be encountered in parking lots. Speed bumps are usually about 3 to 6 inches in height, 1 to 3 feet in length, and force traffic to slow to 5 to 10 miles per hour. Speed bumps may generate severe vertical displacement at low speeds and are not to be used as traffic calming measures.

<p>Advantages:</p> <ul style="list-style-type: none"> ❑ Can be very effective in slowing traffic on residential streets. ❑ Relatively inexpensive to install and maintain. ❑ Can reduce motor vehicle conflicts. ❑ Should not pose problems for bicyclists or motorcyclists, except at high speeds. 	<p>Disadvantages:</p> <ul style="list-style-type: none"> ❑ Watts speed humps are inappropriate for emergency response routes. ❑ Seminole County humps may be considered for emergency routes, but only after close coordination with emergency service providers. ❑ Should be avoided on major transit routes. ❑ Snow removal personnel may require special training in speed hump areas. However, speed humps have been used successfully in many jurisdictions with heavy snowfalls. ❑ Drainage could be a concern.
--	---

Watts (TRRL Profile) Speed Hump

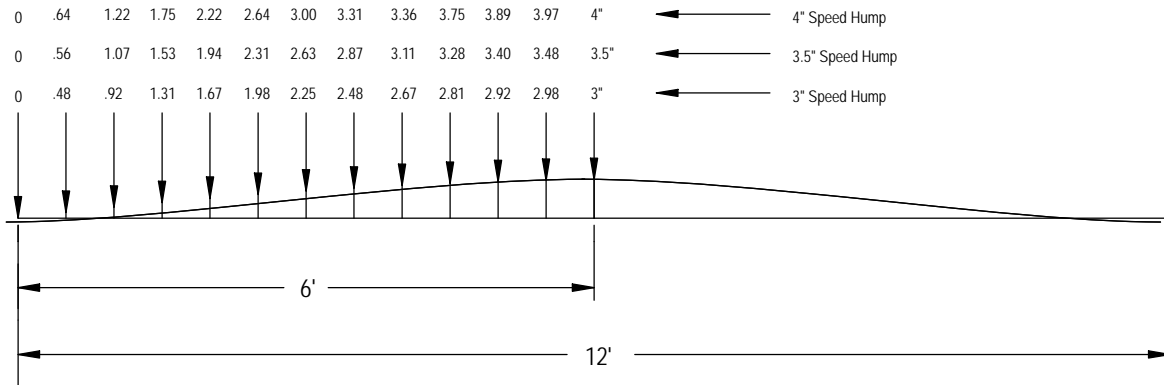

Source: ITE, Guidelines for the Design and Application of Speed Humps

Seminole County Speed Hump/Table

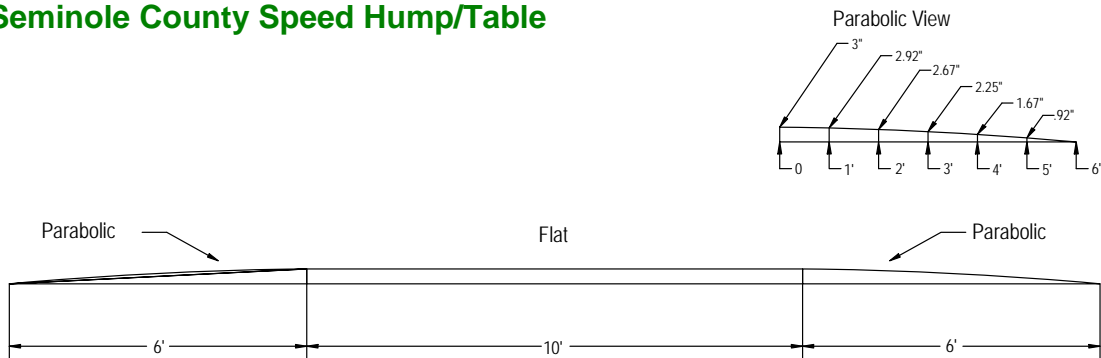

Source: Seminole County, Florida

Note: All signing and pavement markings should utilize the latest applicable standards and manuals.

Gwinnett County Speed Hump/Table

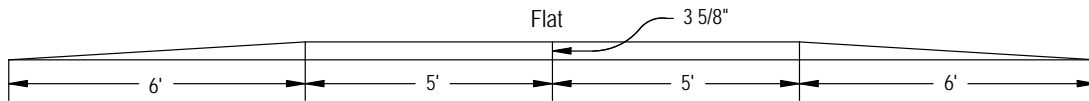

Gwinnett County Speed Hump/Table Shoulder Detail

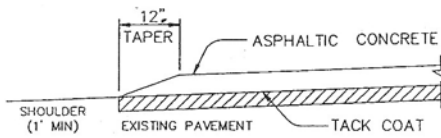
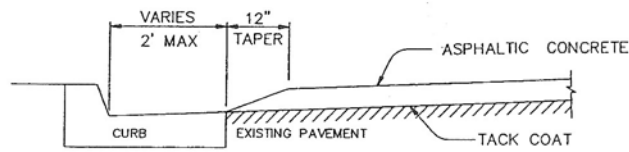

Shoulder Detail For Streets Without Curbs

Source: Gwinnett County, Georgia

Note: All signing and pavement markings should utilize the latest applicable standards and manuals.

SPEED CUSHIONS/SPEED PILLOWS

Description:

Speed cushions, also known as speed pillows, are modified speed humps installed across the roadway width with spaces between each cushion to permit wider axle emergency vehicles to pass without slowing down.

Common Designs:

- ❑ Speed cushions typically consist of three to four cushions (pillows), depending on the roadway width, and are approximately 3-inches high, 6-feet wide, and 7 to 14 feet in length.
- ❑ Standards for design, signage, and pavement markings for speed cushions are currently not outlined by ITE or the MUTCD.
- ❑ Typical design dimensions were obtained from Traffix Logix, City of Mesa, Arizona, Rubberform Recycled Products, LLC, and Traffic & Parking Control Company, Inc. (TAPCO).



Speed Cushion

Source: City of Mesa, Arizona

Appropriate Locations:

- ❑ Speed cushions are appropriate for use on local streets and can be utilized on major emergency response routes.
- ❑ Primarily used at mid-block locations.

Typical Uses:

- ❑ Within typical residential travel speeds, humps create a gentle rocking motion encouraging motorists to slow to a safe speed at or below the speed limit.

Speed/Volume Reductions:

- ❑ A study conducted by the King County Department of Transportation, Washington, indicates a reduction in speed by approximately 15 percent and a reduction in traffic volume by approximately 30 percent.

Signing and Marking:

- ❑ Speed Hump Warning Sign (MUTCD W17-1) is recommended to be installed either 100 feet in advance of the speed cushion, at the cushion, or in both locations. It is also recommended that the "Speed Hump" sign be accompanied by an "Advisory Speed Plaque" (W13-1P).
- ❑ All signing and pavement markings should utilize the latest applicable standards and manuals.

<p>Advantages:</p> <ul style="list-style-type: none"> ❑ Reduction in vehicular speeds. ❑ Reduction of vehicular roadway volumes. ❑ Minimal impact to emergency response times. ❑ Can be incorporated on major emergency response routes. 	<p>Disadvantages:</p> <ul style="list-style-type: none"> ❑ Traffic may divert to surrounding neighborhood roadways. ❑ Snow removal.
---	--

RAISED INTERSECTIONS

Description:

Intersections, including crosswalks, which are raised 3 to 6 inches above street level. Long ramps are included on all approaches.

Appropriate Locations:

- ❑ Commonly found in commercial areas and business districts with high pedestrian activity.
- ❑ Sometimes used in redevelopment areas with an emphasis on neo-traditional design.
- ❑ They are appropriate on local streets and collectors.
- ❑ They are generally not recommended for arterials. However, they may be used very selectively on arterial streets in downtown commercial areas as part of a redevelopment effort where there is support for encouraging pedestrian activity. If used in this manner, coordination with emergency services will be important.
- ❑ They are appropriate on streets with volumes up to 10,000 ADT.

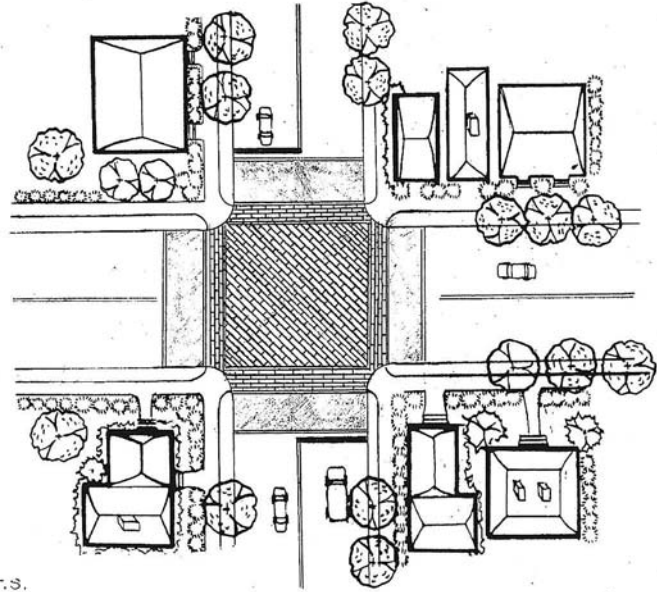

Typical Uses:

- ❑ Reduce vehicle speeds on all approaches.
- ❑ Decrease conflicts between vehicles and pedestrians by better demarcating crossing areas and elevating pedestrians above the street.

Speed/Volume Reductions:

- ❑ Because of their long flat top, and their gently sloped ramps, raised intersections may have only a minor effect on vehicle speeds.

Approximate Cost:

- ❑ Cost of a raised intersection typically ranges from around \$15,000 to \$60,000, but can be more, depending on the width of intersecting roadways and drainage requirements.

Signing and Markings:

- ❑ Advance warning signs should be posted but there is no standard sign for raised intersections, either in the MUTCD or in jurisdictions across the country. The "Raised Pedestrian Crossing" sign (W11-2A) is the recommended warning sign for use with raised intersections in Pennsylvania.

- ❑ All signing and pavement markings should utilize the latest applicable standards and manuals.

Other Considerations:

- ❑ If raised intersections are the same height as the surrounding curb, a slight lip or other tactile measure should be used as a warning to visually impaired people.
- ❑ Textured pavement treatments and curb extensions are often used in conjunction with raised intersections.
- ❑ In areas with snow removal problems, a measure such as a flexible delineator post may be needed at each hump to alert snowplow operators to lift their blades.

<p>Advantages:</p> <ul style="list-style-type: none"> ❑ Reduce vehicle-pedestrian conflicts by providing better visibility for pedestrians. ❑ If pavement treatments and bulb-outs with landscaping are incorporated, the visual environment will be enhanced. ❑ Minor reduction of travel speeds. 	<p>Disadvantages:</p> <ul style="list-style-type: none"> ❑ Expensive to construct and maintain. ❑ Result in an average delay of 4 to 6 seconds for emergency vehicles.
--	---

Raised Intersection

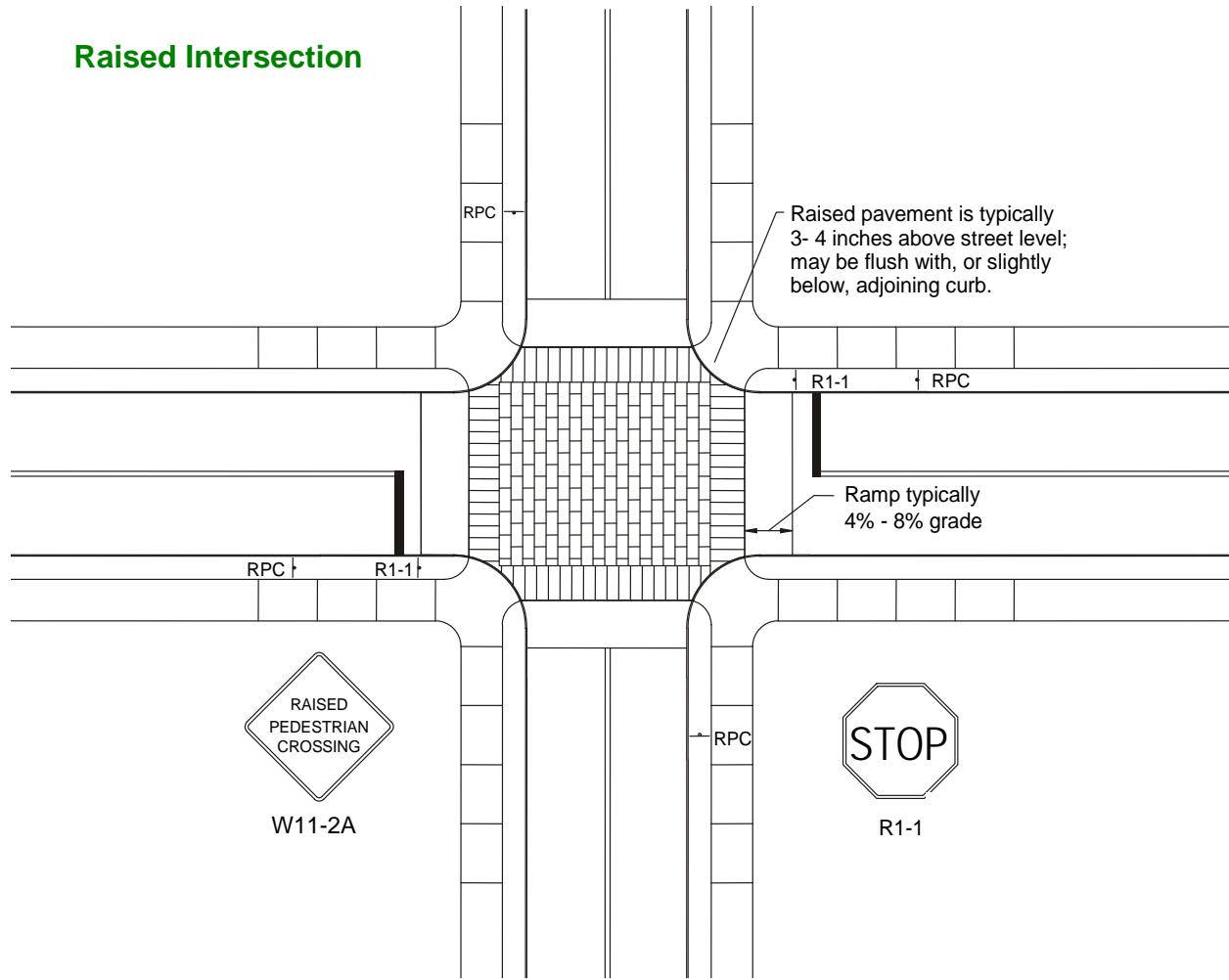

Note: All signing and pavement markings should utilize the latest applicable standards and manuals.

SEMI-DIVERTERS

Description:

Sometimes referred to as half closures or partial diverters, semi-diverters prevent travel in one direction on a street by blocking half the street with a physical barrier. Semi-diverters, normally 16 to 23 feet in length, create a one-way roadway at the point of construction while two-way traffic is maintained on the remaining portions of the roadway.

Appropriate Locations:

- ❑ Semi-diverters are appropriate only on local streets
- ❑ Semi-diverters should be used only at local road intersections with collector or arterial streets, since those roadways can best accommodate the diverted traffic.
- ❑ They should be used only on streets with a documented cut-through problem.
- ❑ They may be used on streets with volumes up to 3,500 ADT.

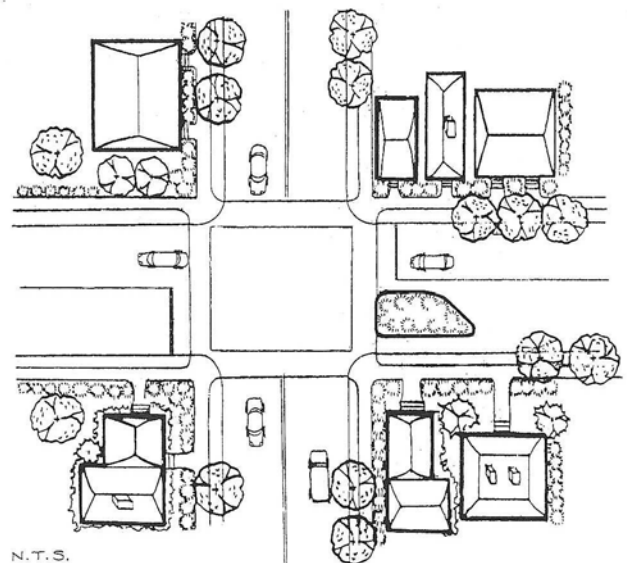

Typical Uses:

- ❑ By eliminating movements, semi-diverters serve to reduce through traffic.

Speed/Volume Reductions:

- ❑ Semi-diverters may normally be expected to reduce traffic volumes by at least 40 percent. However, volume reductions up to 60 percent are common.
- ❑ Speeds may be reduced between 2 to 5 mph.

Approximate Cost:

- ❑ Cost of a permanent measure ranges from \$3,000 (asphalt, pre-cast curb bulb with no drainage modifications) to \$20,000 (measure fully integrated into streetscape with poured-in-place concrete bulb-outs, sidewalks extended, landscaping and drainage modifications).
- ❑ Temporary measures typically cost under \$1,000.

Signing and Markings:

- ❑ Signs, delineation, painted curbs, etc., should be incorporated to enhance visibility.
- ❑ All signing and pavement markings should utilize the latest applicable standards and manuals.

Other Considerations:

- ❑ Traffic barricades can be used to test the effectiveness of a temporary installation.
- ❑ On a permanent basis, semi-diverters can be constructed with curb and gutter or sidewalks and landscaping.
- ❑ A safe bypass for bicycles and wheelchairs should be incorporated in the design.
- ❑ Semi-diverters intended to prevent exit are more readily violated.
- ❑ Semi-diverters at mid-block locations are more frequently violated than end of block measures.
- ❑ A six to twelve-month trial period is recommended before a measure is made permanent.
- ❑ Enforcement may be necessary to keep traffic from violating the directional closure.
- ❑ Semi-diverters should not be used on transit routes or major emergency response routes.
- ❑ Violations may be reduced by extending the length of the semi-diverter.

<p>Advantages:</p> <ul style="list-style-type: none"> ❑ Reduce cut-through traffic without restricting bicycle and pedestrian access. ❑ May lower travel speeds. ❑ Semi-diverters permit emergency vehicles to go around them in the wrong direction (provided there is adequate sight distance), thus allowing a higher degree of emergency access than street closures or diagonal diverters. ❑ Can visually enhance a neighborhood if landscaping is included. 	<p>Disadvantages:</p> <ul style="list-style-type: none"> ❑ Could be violated, especially in the late evening, and particularly on low volume streets. ❑ May require loss of on-street parking opposite the measure to permit emergency vehicle access. ❑ Reduce access for residents.
--	---

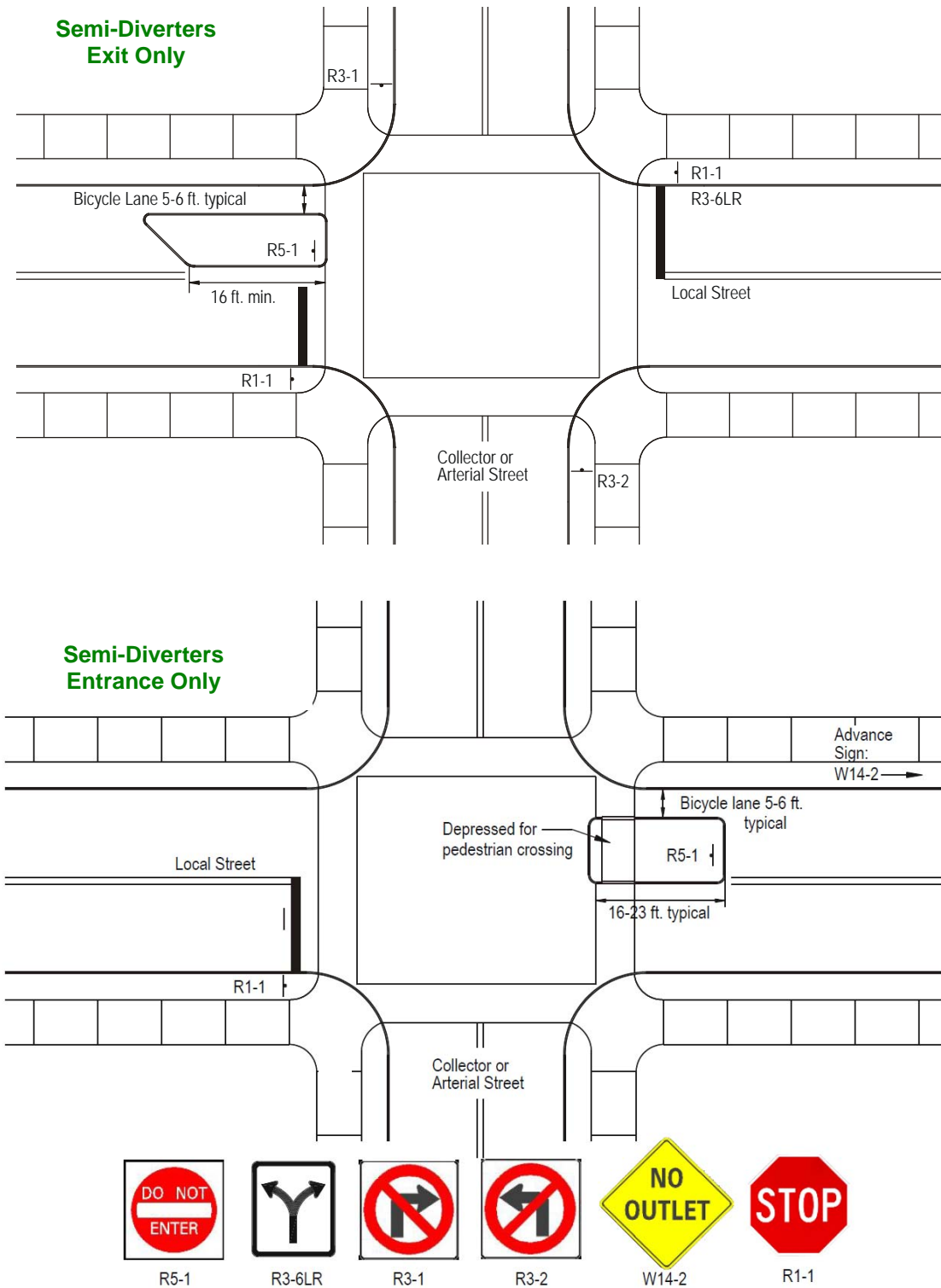

Note: All signing and pavement markings should utilize the latest applicable standards and manuals.

DIAGONAL DIVERTERS

Description:

A diagonal diverter is a physical barrier placed diagonally across a four-way intersection to create two unconnected intersections.

Appropriate Locations:

- ❑ Diagonal diverters are appropriate only for local streets with volumes up to 3,500 ADT.

Typical Uses:

- ❑ Eliminate unwanted through traffic.

Speed/Volume Reductions:

- ❑ Diagonal diverters may be expected to reduce traffic volumes by 20 to 70% (most reductions are around 35%).
- ❑ Slight speed reductions may occur within the immediate vicinity of the measure (within 200 to 300 feet).

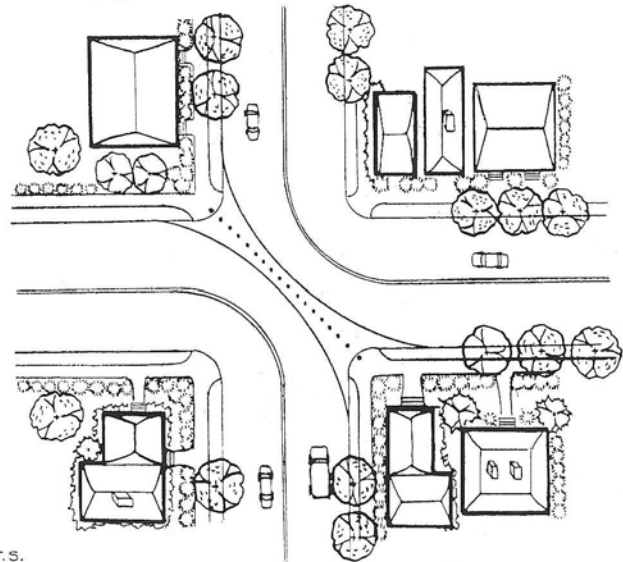

Approximate Cost:

- ❑ Cost typically ranges from \$7,500 to \$20,000 (but can be greater) depending on intersection width, drainage requirements, and landscaping.

Signing and Markings:

- ❑ Diverters should be clearly visible at all times. Painted curbs, delineation, street lights, and advance warning directional arrow signs (W1-6) should be considered.
- ❑ All signing and pavement markings should utilize the latest applicable standards and manuals.

Other Considerations:

- ❑ Collisions may be reduced, but some studies indicate that the collisions are shifted to the collectors or arterials that receive the diverted traffic.
- ❑ Because of their impact on traffic patterns, diagonal diverters can be controversial and should receive strong support before their installation.
- ❑ Diverters can be designed with gaps and curb-cuts for pedestrians, wheelchairs, and bicycles. Provisions should be made for continuity of bicycle routes around the diverter. If necessary, pedestrian crossings can be maintained with sidewalk extensions across the diverter.
- ❑ The radius of the diagonal diverter should reflect the posted speed of the street or the speed should be appropriately modified.
- ❑ Temporary installations and monitoring are recommended prior to construction of permanent measures.

- ❑ Design and location of diverters should be coordinated with emergency service providers. Diverters may be modified with gates, bollards, and mountable curbs to allow emergency vehicle access.
- ❑ Unless the neighborhood is confined to a limited area, installing a single diverter may merely shift through traffic to other local streets. As a result, diagonal diverters generally need to be installed in a group or cluster to effectively route traffic to collector and arterial roadways.

<p>Advantages:</p> <ul style="list-style-type: none"> ❑ Reduce volume. ❑ Reduce crash potential by eliminating conflicting traffic movements. ❑ Lesser impact on traffic circulation when compared to a street closure. ❑ If landscaped, can enhance visual environment. ❑ May reduce speeds. 	<p>Disadvantages:</p> <ul style="list-style-type: none"> ❑ Can shift problems elsewhere unless a strategic pattern of diverters is used. ❑ May inconvenience local residents in accessing their homes. ❑ Delay of emergency service vehicles.
---	---

Typical Applications

Source: Institute of Transportation Engineers'
Traffic Calming – State of the Practice



Boulder, CO



Seattle, WA



Berkeley, CA

RIGHT-IN / RIGHT-OUT ISLAND

Description:

Right-in / right-out islands are a form of intersection channelization that prevents left turns and through movements to and from a side street at an intersection with a major street.

Appropriate Locations:

- ❑ Right-in / right-out islands are appropriate on local streets at intersections with arterials and major collectors.

Typical Uses:

- ❑ Many jurisdictions employ them as a less intrusive (and less expensive) version of a median barrier through an intersection.
- ❑ The primary purpose of this type of channelization is to reduce cut-through traffic on local streets.

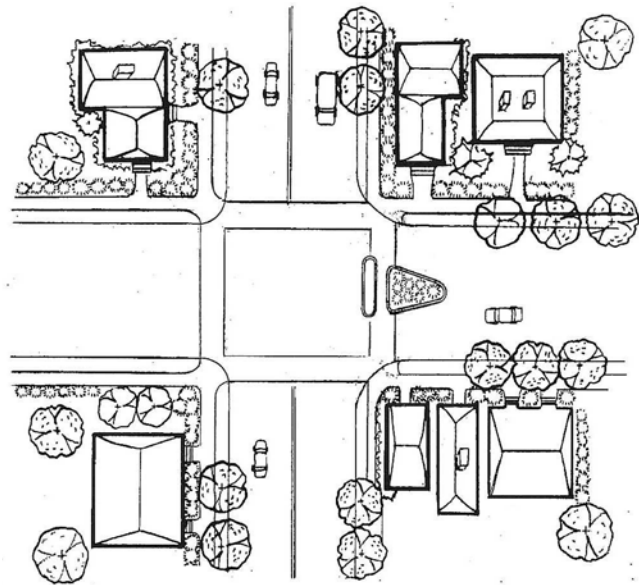

Speed/Volume Reductions:

- ❑ They have little or no impact on speed.
- ❑ Volumes on the major street are unaffected by the channelization, while through traffic on the local street is reduced.
- ❑ They may reduce volumes by 20 to 60%.

Approximate Cost:

- ❑ A right-in / right-out island typically costs \$3,500 to \$7,500, depending on roadway width and specific design features.

Other Considerations:

- ❑ Designs can include depressed or mountable curbs to accommodate oversized vehicles.
- ❑ The island's effectiveness in reducing cut-through traffic will improve when used in combination with other measures on an area-wide basis.

Advantages:

- ❑ Reduce through traffic on local streets.
- ❑ Can improve pedestrian safety by reducing crossing distances and providing refuge areas

Disadvantages:

- ❑ Restrict resident access.
- ❑ May divert traffic to parallel streets without traffic calming measures.

Right-In / Right-Out Island

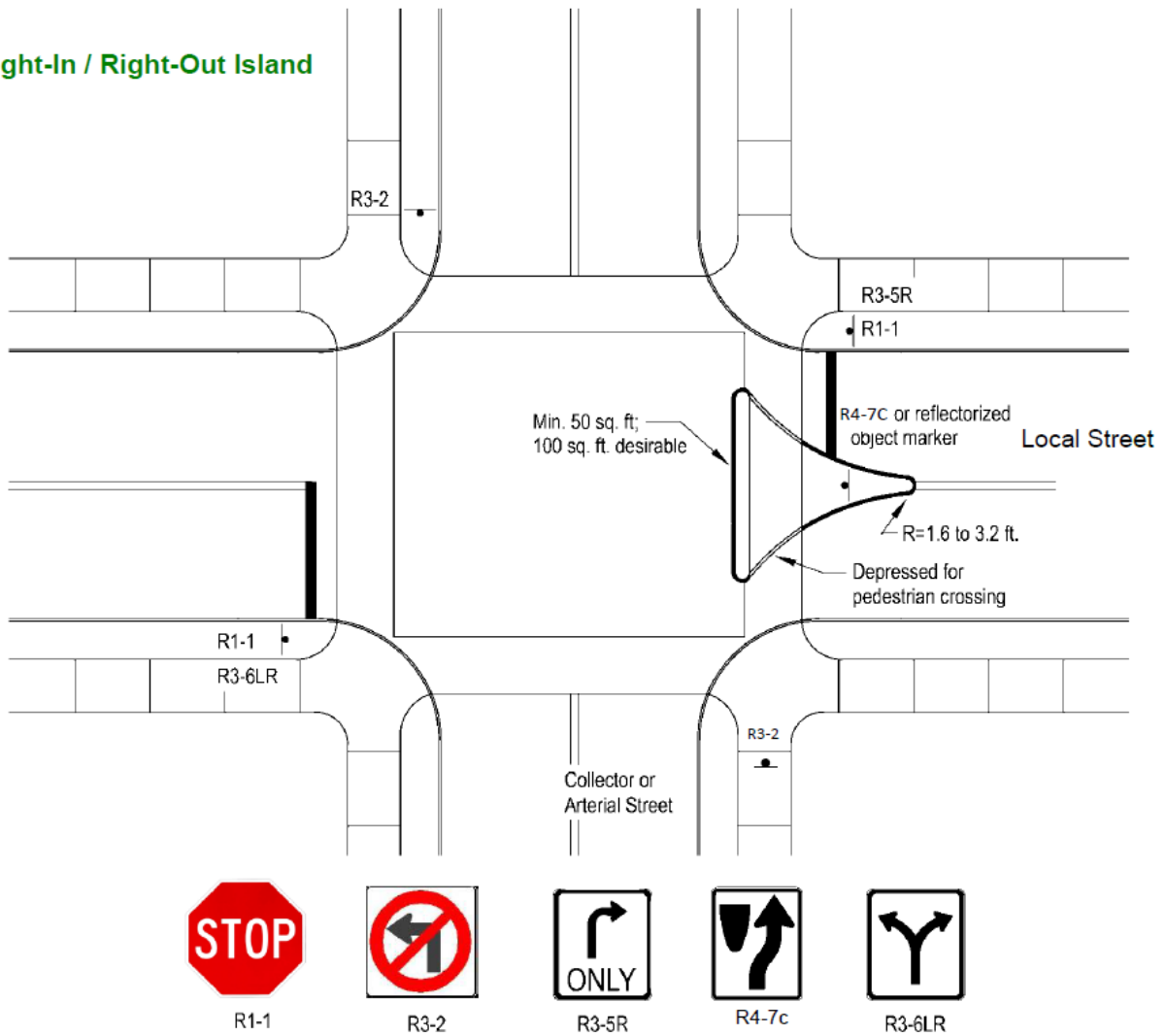

Note: All signing and pavement markings should utilize the latest applicable standards and manuals.

RAISED MEDIAN THROUGH INTERSECTION

Description:

A raised median through an intersection is a barrier which prevents left turns and through movements to and from a local street at an intersection with a major street.

Appropriate Locations:

- ❑ Most appropriate on arterials and major collectors at their intersection with local streets.

Typical Uses:

- ❑ These measures are typically used to prohibit through traffic in a residential area.

Speed/Volume Reductions:

- ❑ Volumes on the local streets may be reduced by up to 70%.

Approximate Cost:

- ❑ Cost ranges from approximately \$1,500 to \$20,000, depending on length and width of barrier, construction materials, and landscaping.

Other Considerations:

- ❑ Median barriers can be constructed in various ways, including a closely spaced row of flexible delineator posts, a series of pre-cast curb sections, and a barrier constructed on a curbed island with landscaping.
- ❑ Given access restrictions, this measure is not recommended for use on a primary fire response route.
- ❑ To avoid shifting traffic from one local street to another, intersection medians should be installed at all local street intersections potentially impacted along the major street.
- ❑ Designs should incorporate gaps that permit access by bicyclists and pedestrians.

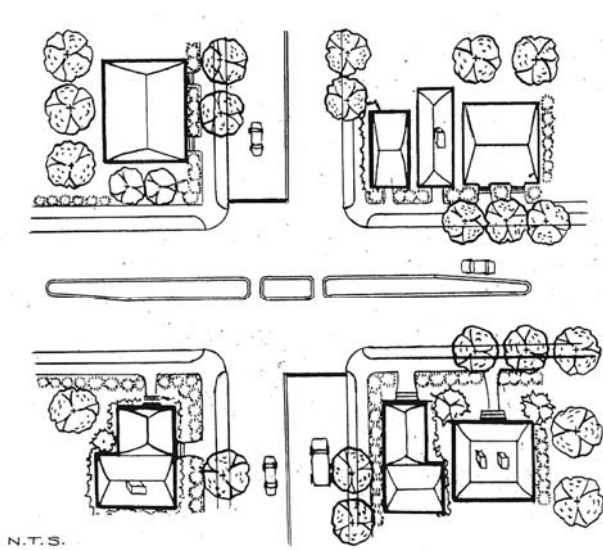

<p>Advantages:</p> <ul style="list-style-type: none"> ❑ Reduce traffic volumes on the local street. ❑ Improves intersection safety by removing conflicting movements. ❑ When landscaped, can improve appearance of the street. 	<p>Disadvantages:</p> <ul style="list-style-type: none"> ❑ May shift traffic to other locations where left-turn opportunities remain. ❑ May affect emergency vehicle access and response.
--	--

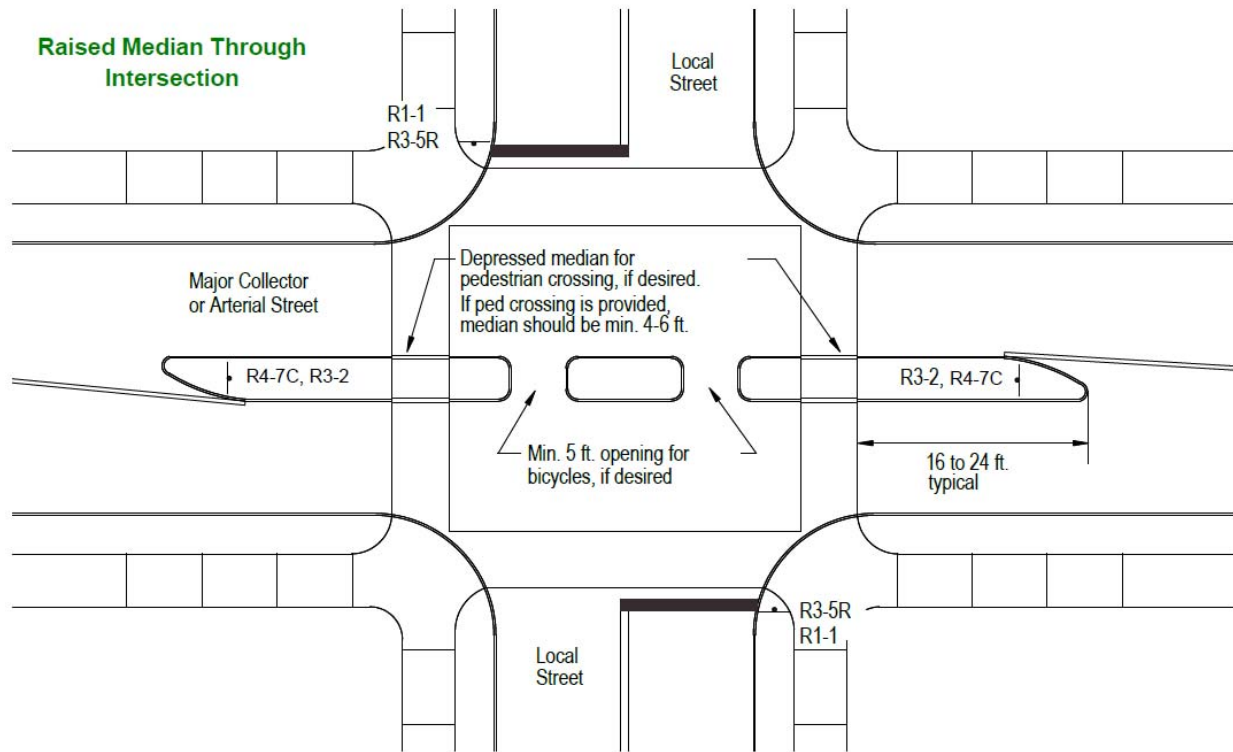

R1-1



R4-7C



R3-5R



R3-2

Note: All signing and pavement markings should utilize the latest applicable standards and manuals.

STREET CLOSURES

Description:

A full street closure is formed by a barrier extending the entire width of the roadway, obstructing all traffic movements and creating a cul-de-sac.

Appropriate Locations:

- ❑ Full closures are appropriate only on local streets with volumes up to 3,000 ADT.

Typical Uses:

- ❑ Closures are intended to change traffic patterns by eliminating unwanted through traffic. Because of their impact on traffic patterns, they can be controversial and should be installed only with strong community support.
- ❑ Street closures are most effective when used in a group in a neighborhood. This creates a maze that effectively eliminates through traffic.
- ❑ Closures can be used to create cul-de-sacs either at an intersection or at mid-block locations. The mid-block type is recommended primarily in locations where adjacent land use patterns change and a high traffic generator borders a residential area.

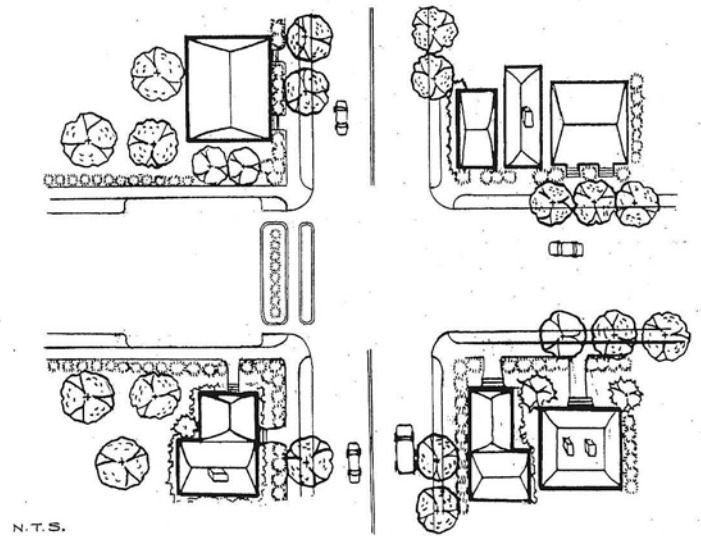

Speed/Volume Reductions:

- ❑ Volumes may be reduced by up to 80% or more.
- ❑ Speeds may also be reduced, particularly if the newly created dead-end street is less than 400 feet in length.

Approximate Cost:

- ❑ Costs start at \$1,500 and may easily range up to \$25,000 or more for closures involving poured-in-place curbs, landscaping, sidewalks, and other features.

Signing and Markings:

- ❑ Proper signing such as “Dead End” (W14-1) or “No Outlet” (W14-2) should be installed at the block entrance warning motorists that the street is not a through street.
- ❑ All signing and pavement markings should utilize the latest applicable standards and manuals.

Other Considerations:

- ❑ When converting an existing residential street, consider the design criteria for cul-de-sacs and dead-end streets in the AASHTO “Green Book” (A Policy on Geometric Design of Highways and Streets).
- ❑ Parking bans on approaches to the turning area can also help facilitate turning movements.

- ❑ The barrier closing the street should be placed at an intersecting through street rather than in the interior of a neighborhood.
- ❑ Street closures should not be installed on transit routes.
- ❑ Pedestrians, bicyclists, and people with disabilities can be accommodated by the provision of through sidewalks and/or ramps.
- ❑ Temporary measures can be created with barricades or other devices and are recommended to test the closure before it is permanently installed.
- ❑ Road closures can serve to deprive the road of its public character by limiting its use, rendering the road ineligible for assistance from the Liquid Fuels fund.

<p>Advantages:</p> <ul style="list-style-type: none"> ❑ Eliminate all cut-through traffic. ❑ Enhance visual appearance of street, if landscaped. ❑ May reduce speeds. 	<p>Disadvantages:</p> <ul style="list-style-type: none"> ❑ Obstruct emergency service access, unless designed with a traversable barrier. ❑ Restrict access for neighborhood residents. ❑ Can shift problem elsewhere in large neighborhoods, unless a strategic pattern of closures is used. ❑ Cul-de-sac may result in loss of on-street parking and/or require the acquisition of property to provide a turnaround area of sufficient diameter.
---	---

Typical Applications

Source: Institute of Transportation Engineers'
Traffic Calming – State of the Practice



Palo Alto, CA



Gainesville, FL



Coral Gables, FL

PEDESTRIAN SAFETY ENHANCEMENT DEVICES

In-Roadway Warning Lights

Description:

In-roadway warning lights are a special type of highway traffic signal installed in the roadway surface to warn users that they are approaching a condition on or adjacent to the roadway that might not be readily apparent and might require the road user to slow down and possibly come to a stop.

Appropriate Locations:

- ❑ In-roadway warning lights may be considered for use at marked school crosswalks, marked mid-block crosswalks, and other roadway situations involving marked pedestrian crossings.
- ❑ They shall not be used at crosswalks controlled by “Yield” signs, “Stop” signs, or traffic control signal.

Signing and Markings:

- ❑ At the location of the crosswalk, a “Pedestrian Crossing Sign” (MUTCD W11-2) and “Arrow Indication Plaque” (MUTCD W16-7P) should be provided.
- ❑ Advance pedestrian crosswalk warning signs should be considered whenever appropriate.
- ❑ All signing and pavement markings should utilize the latest applicable standards and manuals.

Other Considerations:

- ❑ In-roadway warning lights should be clearly visible to approaching traffic from up to 200 feet away.
- ❑ Additional details for in-roadway warning lights are provided in PennDOT's, *Specification for In-Roadway Warning Lights*, *Traffic Engineering Manual*, Publication 46, and FHWA, *Manual on Uniform Traffic Control Devices* (MUTCD).

Intersection Control Beacons

Description:

An intersection control beacon is a flashing beacon used only at an intersection to control two or more directions of travel.

Appropriate Locations:

- ❑ They should be used only at an intersection to control two or more directions of travel with flashing yellow on one route (the major roadway) and flashing red for the remaining approaches, or flashing red for all approaches if at an all-way stop controlled intersection.

Typical Uses:

- ❑ Intersection control beacons are generally used in order to provide adequate visibility to approaching road users.

- ❑ Intersection control beacons may be used at intersections where traffic or physical conditions do not justify conventional traffic control signals, but crash rates indicate the possibility of the need.

Other Considerations:

- ❑ A “Stop Sign” (R1-1) shall be used on all approaches with a flashing red signal indication.
- ❑ Intersection control beacons are generally suspended over the roadways and should not be mounted on a pedestal in the roadway unless the pedestal is within the confines of a traffic or pedestrian island.

Raised Crosswalks

Description:

Raised crosswalks are marked and elevated pedestrian areas that are an extension of the sidewalk at mid-block locations or intersections. Raised crosswalks are typically 3 to 6 inches above street level. In many jurisdictions, raised crosswalks are level with the curb, about 6 inches above the street. They often have the same profile as the Seminole County speed hump.

Appropriate Locations:

- ❑ They are appropriate on local streets and minor collectors at intersections, with volumes less than 10,000 vehicles per day.
- ❑ Placement of mid-block crosswalk for consideration should follow the MUTCD recommended guidelines.

Typical Uses:

- ❑ Reduce speeds and improve visibility of the pedestrians by defining crossings.

Speed/Volume Reductions:

- ❑ Raised crosswalks reduce speeds an average of 6 mph.
- ❑ Volumes are reduced an average of 12%.
- ❑ Due to their long flat tops and gently sloped ramps, raised crosswalks actually slow vehicles less than the Watts speed humps (12 feet in length; 3 inches in height) despite being as much as three inches higher.

Approximate Cost:

- ❑ Cost of a raised crosswalk is approximately \$2,000 to \$10,000 each. If drainage is an issue, costs could increase considerably.

Signing and Markings:

- ❑ At the location of the raised pedestrian crossing, a "Pedestrian Crossing Sign" (MUTCD W11-2) and "Arrow Indication Plaque" (MUTCD W16-7P) should be provided.
- ❑ It is recommended that the "Raised Pedestrian Crossing Warning Sign" (PennDOT W11-2A) be used in advance of each raised pedestrian crossing.
- ❑
- ❑ All signing and pavement markings should utilize the latest applicable standards and manuals.

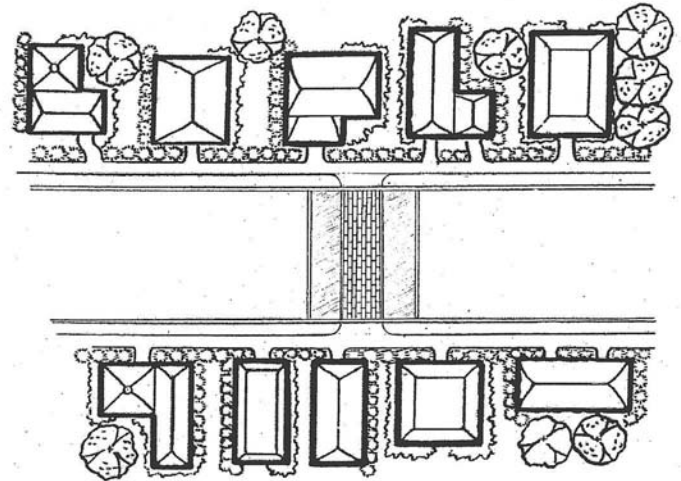

NTS



W11-2A

Other Considerations:

- ❑ If the raised pedestrian crossing is the same height as the curb, the edge of the raised crosswalk should be differentiated with a tactile measure to warn visually impaired people.
- ❑ Most appropriately used at areas with significant pedestrian crossing activity.
- ❑ Effectiveness of the measure is increased when used with curb extensions.
- ❑ Primary emergency access routes should be avoided, unless acceptable to emergency service providers.
- ❑ A catch basin should be installed for drainage on the uphill side of the raised crosswalk.
- ❑ All ADA requirements must be met.
- ❑ In areas with snow removal problems, a measure such as a flexible delineator post may be needed at each hump to alert snowplow operators to lift their blades.

<p>Advantages:</p> <ul style="list-style-type: none"> ❑ Reduce speeds. ❑ Improves visibility for pedestrians. ❑ Improves the visibility of pedestrians. ❑ May reduce volumes. 	<p>Disadvantages:</p> <ul style="list-style-type: none"> ❑ Slows emergency vehicles by 4 to 6 seconds, on average. ❑ May generate noise and additional emissions from vehicle deceleration and acceleration. ❑ Require more maintenance than traditional crosswalks. ❑ Icing can be a problem if snow is not properly removed.
--	---

Raised Crosswalk

For typical profile, see drawings of Seminole County speed table or the Gwinnett County speed table in the "Speed Humps" section.

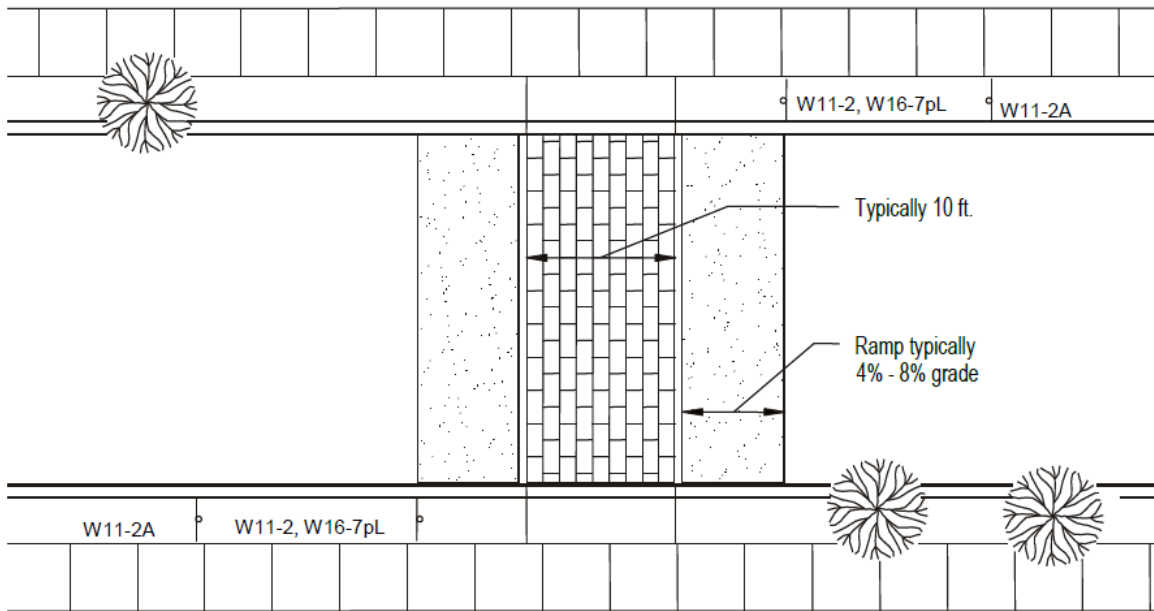

W16-7P



W11-2



W11-2A

Raised Median Islands/Pedestrian Refuges

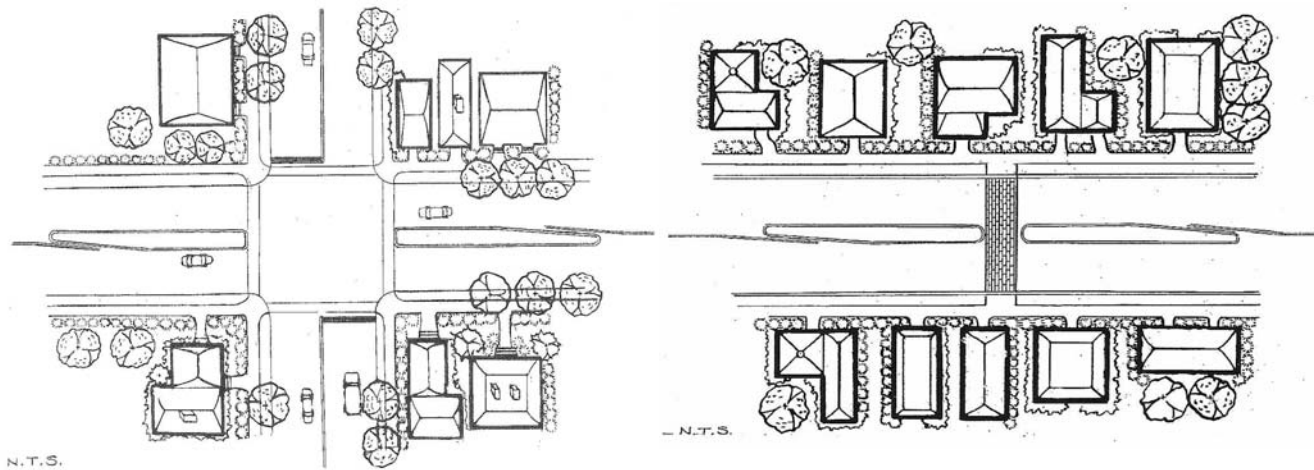

Description:

Median islands are narrow islands between travel lanes that can be designed with breaks in landscaping and curbing for pedestrians.

Appropriate Locations:

- ❑ Median islands may be appropriate for all classifications of streets: local, collector, and arterial.
- ❑ They may be used on high-volume roadways and roadways posted up to 40 mph, if they do not significantly narrow the travel lane.
- ❑ Either at mid-block locations or intersections.

Typical Uses:

- ❑ Reduce the crossing distance for pedestrians by allowing them to cross half the street at a time.
- ❑ Prevent passing movements.

Speed/Volume Reductions:

- ❑ Vehicle speeds may decrease, particularly if the median islands result in roadway narrowing.
- ❑ Reductions in speed may range from 1 to 5 mph, with reductions of 2 to 3 mph most prevalent.

Approximate Cost:

- ❑ Approximate cost is \$5,000 to \$15,000 per island, depending on size, curbing, and landscape features.

Other Considerations:

- ❑ The maximum length of median islands will be affected by driveway and intersection locations.
- ❑ Median islands should be 6 to 8 feet wide to comfortably accommodate pedestrians.
- ❑ Islands should be at least 12 feet, and preferably 20 feet, in length.
- ❑ Provisions should be made for snow and ice removal.

<p>Advantages:</p> <ul style="list-style-type: none"> ❑ Separate opposing vehicle travel lanes and prevent passing movements. ❑ Can be designed with breaks for pedestrian refuges and may reduce vehicle-pedestrian conflicts. ❑ Allow pedestrians to cross half of the street at a time. ❑ May visually enhance the street, if landscaped. ❑ Vehicle speeds may decrease. ❑ Can be used on curves to prevent vehicles from swinging wide at excessive speeds. 	<p>Disadvantages:</p> <ul style="list-style-type: none"> ❑ May require removal of on-street parking to create room for median. ❑ May restrict access to driveways from one direction.
--	--

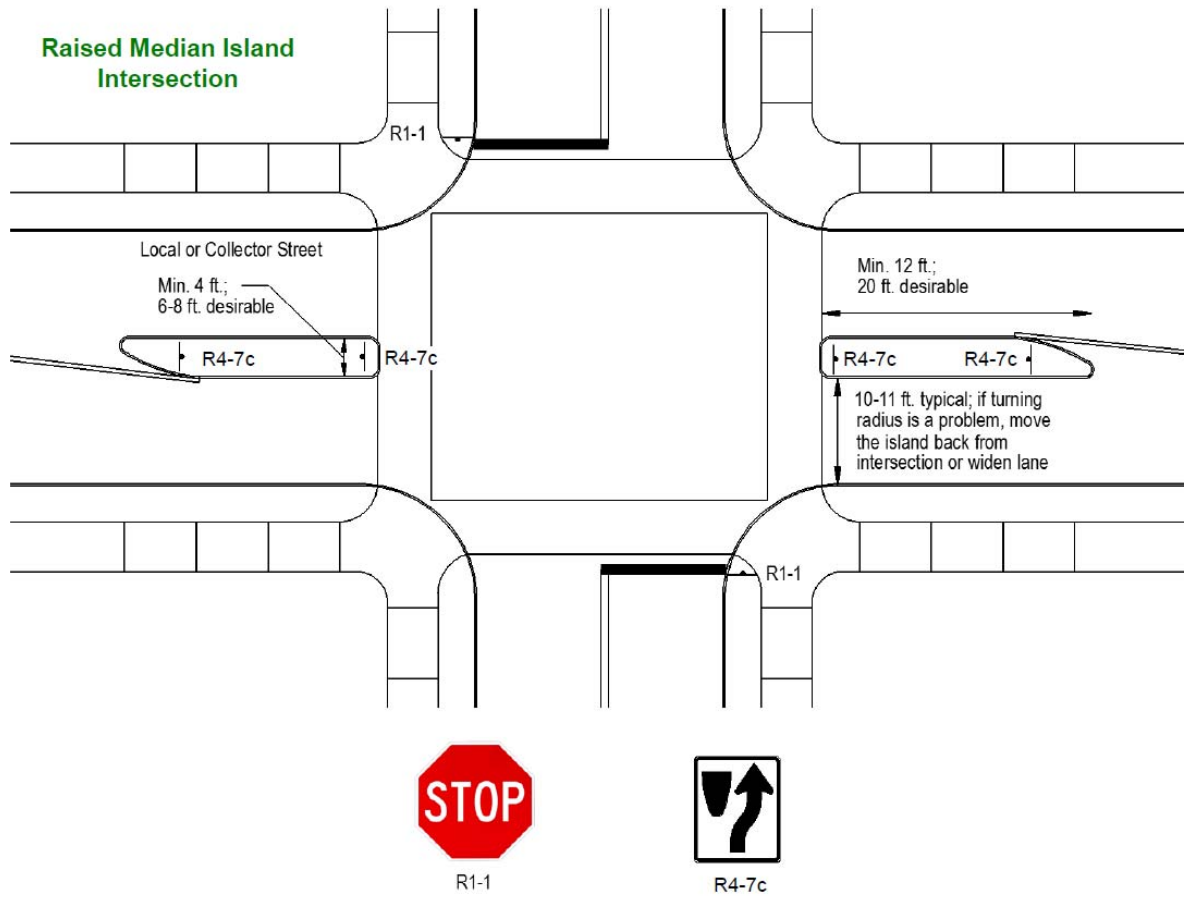

Note: All signing and pavement markings should utilize the latest applicable standards and manuals.

Raised Median Island Mid-Block

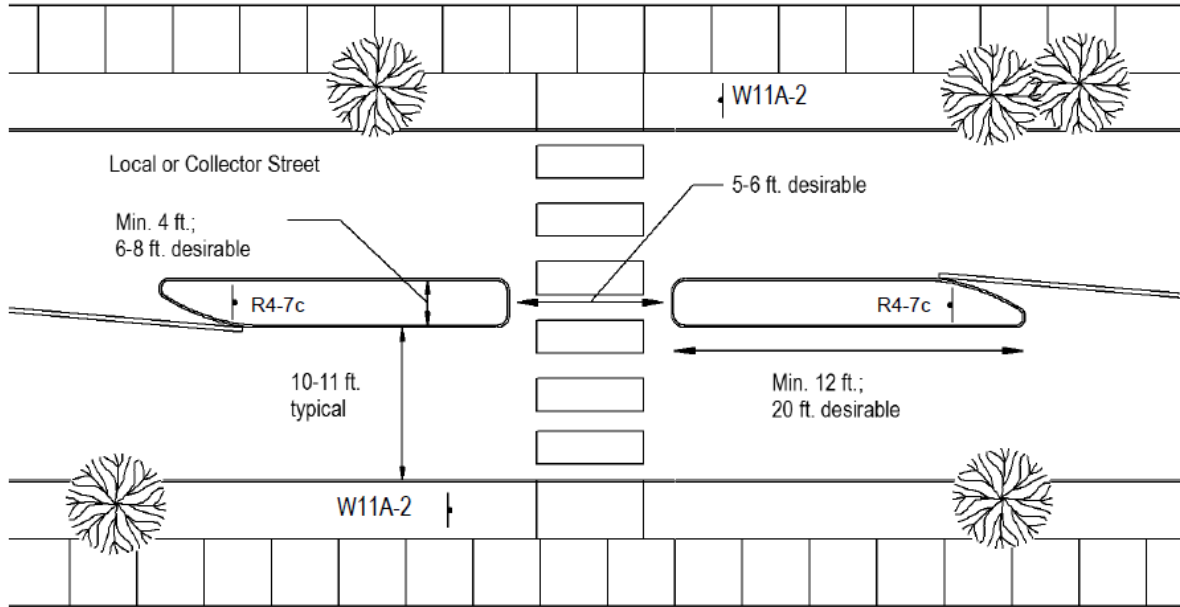

R4-7c



W11-2*



W16-7P

Note: All signing and pavement markings should utilize the latest applicable standards and manuals.

Chapter 6

USE OF SIGNS AND PAVEMENT MARKINGS FOR TRAFFIC CALMING

Although traffic calming has gained a great deal of attention in recent years, traffic engineers have been implementing measures for the past few decades to reduce cut-through traffic and slow traffic in residential areas. These traditional methods of traffic calming generally involved the use of signing and pavement markings. This type of traffic calming can be inexpensive and it can be installed in a short period of time. For these reasons, signing and pavement markings have been used as a “quick fix” for engineers looking to improve the quality of life in residential areas, improve safety in the vicinity of schools and playgrounds, and protect pedestrians in downtown areas. The following information describes a few of the various types of signing and pavement marking devices that have been used to calm traffic.

Signing

The Manual on Uniform Traffic Control Devices should be utilized for all standard signing. All signing should utilize the latest applicable standards and manuals.

Speed Limit Signing

Field investigations of citizen complaints of speeding on residential streets often reveal that very few, if any, speed limit signs are in-place. Although statutory speed limits exist for 25, 35, 55, and 65 mph, only a 55 mph speed limit is enforceable without the posting of speed limit signs. For this reason, residential streets must include speed limit signing if a speed limit other than 55 mph is to be enforceable. The Pennsylvania Vehicle Code (Title 75), §3362 indicates that speed limit signing must be in accordance with Department regulations to include “...posting at the beginning and end of each speed zone and at intervals not greater than one-half mile”. In addition, the installation of speed limit signing will function as a constant reminder of the roadway’s speed limit.

Multi-Way Stop Signs

A common request made by citizens is to use multi-way stop sign control as a means of slowing traffic. However, multi-way stop sign control should only be installed in accordance with the warrants listed in Manual on Uniform Traffic Control Devices. If installed where not warranted:

- ❑ Traffic rarely comes to a full stop.
- ❑ Motorists increase their speed between stop signs to make up for lost time.
- ❑ Residents may gain a false sense of security.

The use of unwarranted stop signs can create disrespect for stop sign control at other locations where it is truly needed.

As the volume disparity increases between opposing traffic flows at an intersection, the stop control is increasingly disobeyed by the motorists on the higher volume street. Unwarranted multi-way stop controls are particularly dangerous where vehicle speeds through the stop sign are greater than 10 mph. This situation is very common when streets are wide, sight distances are good, and the opposing traffic ratio is greater than 60/40. Typically, regardless of the volumes, most motorists tend to obey stop signs if the traffic split is no greater than a 60/40 ratio.

When implemented after a proper engineering study, multi-way stop control is an excellent tool to reduce right angle crashes. As previously stated, multi-way stop control should not be used for controlling speeds.

Turn Prohibitions

Turn prohibitions are an excellent “quick fix”, that can be used for both 24-hour or part-time applications (restrictions that address problems during specific time periods, such as 7:00 AM to 9:00 AM or 4:00 PM to 6:00 PM). One drawback is that the residents living in the area must also abide by the posted restriction. In addition, periodic enforcement is essential to ensure continued compliance with the restriction.

If the cut-through traffic occurs only during certain peak hours, part-time applications should be used. When turn prohibitions are used in this application, supplemental signing indicating the restricted hours when the prohibition is in-place must be included.

One-Way Streets

Since turn restrictions are only spot controls, they may be violated with some frequency by motorists in the absence of police enforcement. A more effective control may be to create a one-way street. One-way streets are often implemented in parallel pairs to ensure a good circulation pattern.

One-way streets should only be implemented after careful evaluation. This type of measure is far more restrictive to the residents living on the street than a turn prohibition. In addition to their restrictive nature, speeds tend to increase on one-way streets due to fewer conflicts and a wider travel lane. If this occurs, additional traffic calming efforts may be needed.

PAVEMENT MARKINGS

The Manual on Uniform Traffic Control Devices should be utilized for all standard pavement markings. All pavement markings should utilize the latest applicable standards and manuals.

Roadway Narrowing with Edge Lines

Many residential streets have been constructed to such a width that getting motorists to obey a 25 or 30 mph posting is extremely difficult. In addition, it can be costly to physically narrow the roadway or install various physical traffic calming measures. A low-cost way of reducing speeds is to narrow the roadway lane through the use of edge lines and centerlines. A number of jurisdictions across the country have installed this type of pavement marking application to create 9 to 10-foot-wide lanes. These applications have generally reduced speeds by 1 to 2 mph with reported reductions as high as 5 mph in some locations. This pavement marking application is appropriate on local streets and low-volume minor collectors, but should not be used on major collector or arterial streets.

Transverse Markings

Double thick thermoplastic transverse pavement markings have been successful in slowing traffic in diverse areas such as school zones, hospitals, approaches to severe curves, and stop signs. These markings typically consist of five transverse, 6-inch-wide stripes, installed 2 feet on center, repeated every 100 feet. Depending on conditions, three to five sets of clusters are installed per approach.

It is estimated that each cluster reduces approach speeds by 1 to 3 mph. As vehicles travel over these thermoplastic markings the noise and vibration alerts the driver. Because of the noise they generate, it may be inappropriate to use this application in locations with nearby residents.

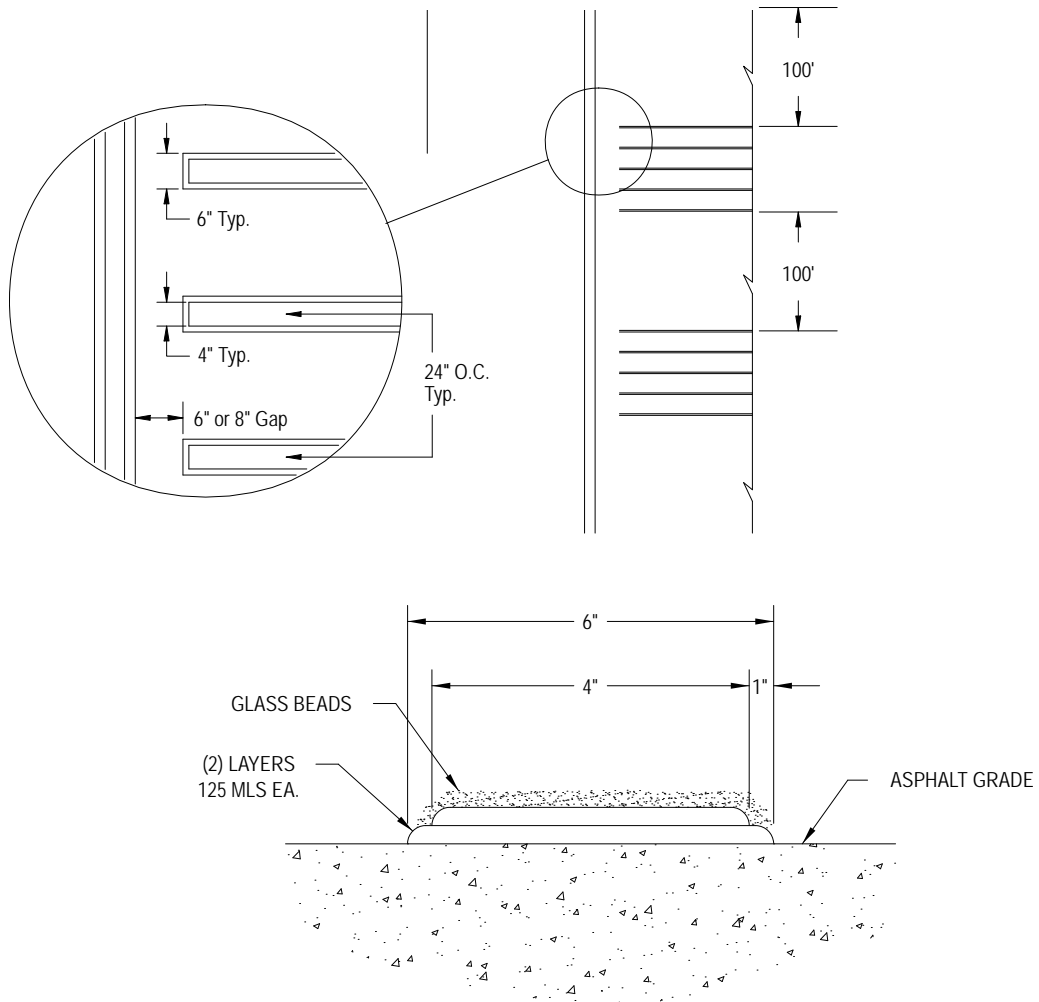

Chapter 7

TRAFFIC CALMING PLANNING AND DESIGN FOR NEW AND RECONSTRUCTED STREETS

Traffic calming for new developments is a fairly new topic that was introduced in the Institute of Transportation Engineers *Traffic Calming: State of the Practice*. When guidelines for traffic calming were initially developed, the purpose was to study and document existing problematic conditions that require retrofitting of traffic calming measures. However, traffic calming for new developments are implemented to prevent potential traffic safety related problems from developing and to restore streets to their intended function of safely moving vehicles and pedestrians.

The following sections outline the current relationship of traffic calming to Complete Streets, PennDOT Smart Transportation principals and traffic calming, speed management and traffic calming, and traffic calming features for new developments.

Complete Streets

A complete street is a road that is designed to be safe for drivers, bicyclists, transit vehicles and users, and pedestrians of all ages and abilities. The complete streets concept focuses not just on individual roads but on changing the decision-making and design process so that all users are routinely considered during the planning, designing, building and operating of all roadways.

Traffic calming, as defined by ITE, is *“the combination of mainly physical measures that reduce the negative effects of motor vehicle use, alter driver behavior, and improve conditions for non-motorized street users”*. Traffic calming plays an important part in complete streets. The design measures are utilized to reduce high speeds and cut through traffic on local roadways, which increases the safety of pedestrians and bicyclists, and improve the quality of life within the neighborhood. However, traffic calming measures are largely intended to address unforeseen problems that arise after roadways are constructed.

The implementation of complete streets ideology involves designing a street with pedestrians in mind. Sidewalks, raised medians, better bus stop placement, traffic-calming measures, and treatments for travelers with disabilities are all considerations for complete streets, and these devices may reduce pedestrian risk by as much as 28 percent. Connectivity is also a main idea in complete street design. Gridded networks need not rely on overly-wide roads and have more intersections, lowering driver speeds.

In an example of complete street implementation in San Francisco, a “Road Diet” on Valencia Street reduced automobile through lanes from four to two, adding a center turn lane and two bike lanes. Following this change, collisions involving pedestrians declined 36%, accompanied by an increase in pedestrian traffic and a 140% increase in bicycle riders, all without significantly altering automobile traffic capacity.

The Complete Streets website (www.completestreets.org) emphasizes the importance of incorporating complete street ideas into a project before it is built in order to prevent costly delays and retrofits. Certain complete street devices may not be practical in situations where new roadways are not being constructed. However, options such as providing frequent and safe pedestrian crossing opportunities, median islands, curb extensions, or narrower travel lanes are all examples of complete street ideas that can be retrofitted to an existing street and can also help in traffic calming.

Smart Transportation

The Pennsylvania Department of Transportation and the New Jersey Department of Transportation partnered together to develop the *Smart Transportation Guidebook*. The guidebooks goal is to integrate planning and design of streets and highways in a manner that fosters development of sustainable and livable communities. This includes creating transportation facilities that work well for all users, are affordable, and support smart growth. Designs should include elements that encourage drivers to slow down to speeds appropriate to local conditions, which can be achieved through traffic calming. Further details can be found in the Smart Transportation Guidebook.

The Smart Transportation Guidebook also incorporates a new roadway classification system that expands the traditional classifications used for many local municipalities. This expanded classification system and associated new roadway design standards provide an expanded system that could be used when developing a traffic calming policy.

The four traditional roadway classifications presented in the AASHTO Green Book are: Principal Arterial, Minor Arterial, Collector (subdivided into major collector and minor collector within rural areas), and Local. The Smart Transportation Guidebook suggests a revised roadway typology to address the problem of entire roadways being classified as one type based on select characteristics. This typology contains more narrowly focused characteristics including access, mobility, and speed. The table below presents the expanded roadway classifications as presented in the Smart Transportation Guidebook.

Roadway Classification:

Roadway Class	Roadway Type	Desired Operating Speed (mph)	Average Trip Length (mi)	Volume	Intersection Spacing (ft)	Comments
Arterial	Regional	30-55	15-35	10,000-40,000	660-1,320	Roadways in this category would be considered "Principal Arterial" in traditional functional classification.
Arterial	Community	25-55	7-25	5,000-25,000	300-1,320	Often classified as "Minor Arterial" in traditional classification but may include road segments classified as "Principal Arterial."
Collector	Community	25-55	5-10	5,000-15,000	300-660	Often similar in appearance to a community arterial. Typically classified as "Major Collector."
Collector	Neighborhood	25-35	<7	<6,000	300-660	Similar in appearance to local roadways. Typically classified as "Minor Collector."
Local	Local	20-30	<5	<3,000	200-660	

The Smart Transportation Guidebook also provides recommended roadway design elements based on the revised roadway classifications presented above. The table below summarizes the design elements per roadway classification.

Design Elements:

	Paved Shoulder	Parking Lane	Bike Lane	Median (physical or two-way left turn lane)	Sidewalk*
Regional Arterial	Recommended for rural, suburban corridor, suburban neighborhood contexts	Evaluate for urban contexts	Evaluate for suburban center and urban contexts	Recommended for multi-lane roads; evaluate on other roads	Recommended for urban contexts; recommended for suburban contexts as appropriate
Community Arterial	Recommended for rural, suburban corridor, suburban neighborhood contexts	Recommended for urban contexts; evaluate for suburban center, suburban neighborhood contexts	Evaluate for suburban and urban contexts	Recommended for multi-lane roads; evaluate on other roads	Recommended for urban contexts; recommended for suburban contexts as appropriate
Community Collector	Recommended for rural and suburban corridor contexts; evaluate for suburban neighborhood	Recommended for urban, suburban center contexts; evaluate for suburban neighborhood	Evaluate for suburban and urban contexts	Recommended for multi-lane roads	Recommended for urban contexts; recommended for suburban contexts as appropriate
Neighborhood Collector	Recommended for rural, suburban corridor contexts	Recommended for urban, suburban center, suburban neighborhood contexts	Evaluate for suburban and urban contexts	Consider primarily for aesthetic enhancement	Recommended for urban contexts; recommended for suburban contexts as appropriate
Local	Evaluate for rural contexts	Recommended for urban, suburban center, suburban neighborhood contexts	Typically not needed	Consider for aesthetic enhancement only	Recommended for urban contexts; recommended for suburban contexts as appropriate

*Sidewalks are recommended as part of State and Federally funded roadway projects in suburban context unless one or more of the following conditions is met:

- Pedestrians are prohibited by law from using the roadway.
- The cost of installing sidewalks would be excessively disproportionate to the need of probable use.
- Sparsity of population or other factors indicate an absence of need.

Speed Management

The goal of speed management is to reduce speeding-related fatalities, injuries and crashes. The Federal Highway Administration (FHWA) published the Speed Management Strategic Initiative in September 2005. The strategies and actions of this initiative are grouped under five main objectives:

1. Better define the relationship between speed and safety.
2. Identify and promote engineering measures to better manage speed.
3. Increase awareness of the dangers of speeding.
4. Identify and promote effective speed enforcement activities.
5. Obtain cooperation and support of stakeholders.

These strategies are designed for implementation across various jurisdictions and on different types of roadways. They incorporate a balanced, 3E approach -- engineering, enforcement and education -- including technologies designed to aid in mitigating a specific problem. Traffic calming measures can be utilized for objective 2, measures to better manage speed. Further details can be obtained in the Speed Management Strategic Initiative.

Traffic Calming Features for New Development

The goal of traffic calming measures for new developments is to provide a neighborhood street network that discourages excessive speeding, precludes congestion and minimizes the potential for excessive cut-through traffic.

Design elements and features for new developments could include:

Street Network Elements:

- ❑ Short segment: A straight, uninterrupted street segment should not exceed 660 feet between cross street centerlines. Short segments diminish the opportunity for vehicles to gather speed.
- ❑ Curve: Horizontal and vertical curves should be utilized on longer, uninterrupted street segments. The curve should be of such radius as to limit the sight distance from any cross street between 150 and 300 feet. A limited sight distance forces slowing of vehicles.
- ❑ Elbow and Tee: Intersection should be limited to 90-degree elbows and tees whenever practical. Right angles force slowing.
- ❑ Dead end: A short-stemmed dead end (e.g. cul-de-sac) can discourage cut-through while preserving a neighborhood's walkability. A dead end is short-stemmed is a drive along the cross street can tell that it is a dead end without the aid of signs and without having to turn into the dead end street. Dead end streets discourage cut-through traffic.

Roadway Features:

- ❑ Median island: A landscaped median island may be added to break a long and uninterrupted, straight segment of street, or at approaches to intersections.
- ❑ Curb extension: Street corners may have the curb extended into the roadway to discourage fast turns around the corner. Curb extensions also shorten street crossing distances for pedestrians.
- ❑ Raised crosswalk: An elevated crosswalk can lend higher visibility to pedestrians and slow traffic on approaches to intersections.
- ❑ Speed hump: Properly designed and installed, speed humps can "enforce" neighborhood speed limits at all hours every day of the week.
- ❑ Traffic circle: Four-legged intersection may be considered if controlled with a traffic circle. Traffic circles assign right-of-way safely and efficiently, and also force slowing of vehicle traffic.
- ❑ Gateway: Medians, curb extensions, traffic circles, monuments and arches may be placed at entrances to residential neighborhoods to demarcate the street network from the arterial roadway system, serving as a visible reminder for motorists to adapt their driving attitude and behavior to the changed environment.
- ❑ Paths and trails: Bike paths and trails within parkways promote pedestrian activity alongside the street.

Appendix A

ADDITIONAL FINDINGS ON TRAFFIC CALMING ISSUES

Additional information on the topics presented in Handbook was gathered during the research and development process. This appendix provides information that may be in greater detail than what is presented in the chapters, or variations on ideas presented in the “Study and Approval Process”. It is intended as an additional reference that can be used when formulating a traffic calming program.

Funding Issues

- Compared to other transportation expenditures for local governments, traffic calming program expenses are not significant. Perhaps for this reason, local governments nationwide have used a great variety of sources to fund their traffic calming programs. The following is a discussion of different funding sources that are being employed by local governments. This information comes from a study at the University of California-Berkeley in 1998¹. Sixty-three local governments were surveyed as part of this study.

University of California Study Findings

Asha Weinstein and Elizabeth Deakin at the University of California conducted in-depth interviews with 63 local governments on funding sources for their traffic calming programs. Their study found that most traffic calming programs were paid for out of general revenues and State gas tax subsidies. Eighteen of the jurisdictions surveyed (29%) required residents to pay some or all of the costs of traffic calming. The amount paid by residents sometimes depends upon the extent of the traffic problem. For example, Dallas has set up a sliding scale whereby residents bear 100% of the costs if the 85th percentile speed exceeds the posted speed limit by 5 mph or less. The City contributes 20% of the costs for each 1 mph increase over this speed, until they pay the entire amount if the 85th percentile speed exceeds the speed limit by at least 10 mph. Some jurisdictions normally pay for all traffic calming costs, but allow neighborhoods that are low on the priority list to pay for measures themselves as a means of expediting their installation. Other municipalities fund engineering and construction, but allow residents to fund optional landscaping and beautification treatments.

If residents do contribute to the cost of installing traffic calming measures, the funds may be collected in different ways. In some places, a local improvement district was established and the funds were raised from property tax assessments. Sometimes, residents simply raised the funds themselves and turned them over to the local government.

One objection that has been made to requiring neighborhoods to fund traffic calming measures is that such an approach may discriminate against low-income areas. On the other hand, it has been argued that traffic calming measures benefit only the neighborhood where they are installed, not the general public, and it is thus appropriate to make the neighborhood responsible for the costs. Several of the local governments contacted for the University of California study indicated that making residents pay for measures had tempered the number of requests from the public.

¹Asha Weinstein and Elizabeth Deakin, University of California. “How Local Jurisdictions in the United States Finance Traffic Calming.” Paper for the Transportation Research Board 78th Annual Meeting, January 10-14, 1999.

The University of California study also found that 10 of the 63 jurisdictions had required developers to fund traffic calming measures in existing neighborhoods as part of development approval. On three different projects, Ada County, Idaho had collected between \$5,000 to \$10,000 from developers for traffic calming measures to mitigate traffic impacts.

The University of California study found little interest in using ISTEA funds for traffic calming projects. Four jurisdictions surveyed had reported expending ISTEA funds on traffic calming, but these proved to be largely pedestrian and bicycle improvement projects in which traffic calming was not the primary motive. (It should be noted that some pedestrian improvement projects do have the potential to calm traffic.) Many of the local governments surveyed indicated that traffic calming projects were too small or were not significant enough to justify pursuing ISTEA funds. On the other hand, seven of the 63 jurisdictions had used CDBG funds for traffic calming.

The study also cited less common funding sources that have been used by several jurisdictions. Seattle, Washington and Albuquerque, New Mexico have raised funds for their traffic calming programs from bond initiatives. Fresno, California has paid for bulb-outs in its central business district from tax-increment funds. Minneapolis, Minnesota has funneled tax increment funds into its Neighborhood Revitalization Program, which, in turn, may be used for traffic calming improvements. Sacramento, California has supported its neighborhood traffic management program with grants from the State Office of Traffic Safety. One jurisdiction drew upon funds from city and county license plate fees.

Community Approval

Unlike traffic control devices, which are installed according to the system of warrants as presented in the Manual on Uniform Traffic Control Devices (MUTCD), the use of traffic calming measures in the United States is much more discretionary. Frequently, more than one traffic calming measure can be used to solve the same problem. Further, most effective traffic calming measures typically present at least modest inconvenience for segments of the community in which they are installed. Community involvement can help residents better understand the benefits and limitations of different traffic calming measures in addressing the perceived traffic problems in their neighborhoods. Residents will be more likely to support a traffic calming measure or area-wide plan if they feel they have been adequately consulted with and even participated in its preparation. By the same token, a governing body will be more likely to support a plan if they perceive community satisfaction. For all these reasons, an organized community involvement process is an essential element of any traffic calming program.

In jurisdictions with successful traffic calming programs, there is generally no lack of interest in traffic calming measures, and thus no shortage of residents willing to participate in the program. In fact, individual residents or neighborhood associations virtually always initiate the process of installing traffic calming measures. The requests for the installation of traffic calming measures often overwhelm the amount of funds budgeted for the program.

There must be strong agreement by the neighborhood that traffic calming is needed to control traffic problems in the area. This agreement helps reduce second thoughts about a measure once it has been installed and the subsequent requests to remove the measure that would follow.

Community approval is generally sought at any/all of the following three points in the traffic calming plan development process:

1. At the beginning of the process, to demonstrate to the local government that sufficient support exists for serious investigation of traffic calming measures.
2. After the neighborhood traffic calming plan has been developed, including design of the measure, to demonstrate that support exists for installing a particular measure or measures.

3. After the test installation of a temporary traffic calming measure, to determine whether the measure should be installed permanently.

Local governments usually require neighborhoods to approve petitions at two of the above three points in the process. For certain projects, Portland, Oregon requires neighborhood approval at all three points, but only for diverter projects or for new traffic management measures that have not been tested elsewhere in the city. (Diverters have the greatest potential for shifting traffic volumes to parallel local streets and, correspondingly, can create the greatest controversy.)

Many local governments have substituted less-intensive demonstrations of community support for neighborhood-wide petitions at key points in the process. Neighborhood or homeowner associations are often asked to vote on their support for developing a traffic calming program. Alternatively, an entire neighborhood may be asked to approve a petition for drawing up a traffic calming plan, but only those neighborhood residents who participate in the neighborhood traffic committee must agree to the final plan. In an unusual procedure, Phoenix, Arizona requires signatures from 10 residents in a neighborhood before beginning a traffic calming study. While the procedures for approving traffic calming plans may vary, they all have the common goal of assuring that a traffic calming program does not rest upon the dissatisfaction of only one or several neighborhood residents.

Traffic Data Gathering Process

Determining Eligibility

The large majority of traffic calming programs in place in the United States uses functional classification and land use as determinants of whether roadways qualify for these programs. Typically, local streets, and collector streets with predominantly residential land uses, are eligible for the traffic calming program. State-owned roadways that function as arterials, primarily in downtown districts and commercial areas, are considered for the least intrusive traffic calming measures, such as bulb-outs, mid-block islands, and pedestrian refuge areas.

Basic traffic data is gathered at the beginning of a study to provide objective evidence on whether a traffic problem exists. At a minimum, the average daily traffic (ADT) volume, the average speed, and preferably the 85th percentile speed on the street is normally determined. A large majority of traffic calming programs require that the ADT exceed 1,000, and/or that the 85th percentile speed exceed 5 mph over the posted speed limit before the street can qualify for the program. In essence, these requirements serve as guidelines for their programs.

Other programs require the 85th percentile speed to exceed 7 to 10 mph over the posted speed limit. Collier County, Florida requires that the median speed (middle value in series of spot speeds) exceed the posted speed limit by 5 mph.

In the Virginia Department of Transportation (VDOT) traffic calming program, streets may qualify based either on meeting the two requirements of minimum volume and excess speeds, or on simply documenting a high level of cut-through traffic. For the latter requirement, streets must have a minimum of 150 cut-through trips in one direction in one hour, and cut-through trips must comprise 40 percent of the total one hour, single direction volume.

Monitoring and Evaluation

The New York State Department of Transportation's (NYSDOT) traffic calming guidelines indicate that the factors monitored should reflect the objectives of the project and may help assess priorities for funding. Depending on the particular situation, crashes, traffic speeds, traffic flow, or diversion to other routes may be monitored. NYSDOT provides guidelines to assist in determining which parameters can be

reasonably measured and have some direct relationship to the traffic calming measure installed. This information can include:

- ❑ Before and after crash statistics to determine annual rates of crashes per million vehicle miles and injuries for all crashes, motor vehicle/bicycle crashes, motor vehicle/pedestrian crashes, and transit crashes. Crash studies should be performed to determine how crash trends in the project area have been affected and should cover a length of time sufficient to identify long-term effects.
- ❑ Before and after speed studies to determine the 85th percentile speed, the 10 mph pace and percent of vehicles within it, and the numbers of priority investigation locations and high crash locations eliminated. Speed studies should be performed upstream of, at, and downstream of the traffic calming feature to identify its effect on vehicle speeds.
- ❑ Before and after traffic volume, including the average daily traffic (ADT), the average annual daily traffic (AADT), the design hour volume (DHV), and the directional design hourly volume (DDHV). Traffic counts should be made on the street where traffic calming will be installed and on the streets to which traffic is expected to divert. The “after” counts should be made after traffic patterns have stabilized.
- ❑ Parking occupancy.
- ❑ Level of community satisfaction.

While NYSDOT provides details on monitoring, Virginia Department of Transportation’s “Residential Traffic Calming Guide, Pilot Program (January 1998 - December 1999)” guidelines include only the following evaluation requirements:

- ❑ “A follow-up evaluation will be performed to ensure that the traffic calming measures are effective. The board of supervisors in cooperation with VDOT will determine the method to disseminate the findings and recommendations to those involved in the plan development and obtain feedback as appropriate.”

Appendix B

SOURCES

Interviews

- Atkins, Crysttal - Portland, Oregon; January 8, 1999.
- Bradley, Dan - Burlington, Vermont; December 23, 1998 and January 19, 1999.
- Bunn, Bob - Richmond, California; December 23, 1998.
- Celniker, Steve - City of San Diego, California; July 2, 1999.
- Davis, Steve - Fort Wayne, Indiana; December 23, 1998.
- Frangos, George - Howard County, Maryland; December 23, 1998 and July 2, 1999.
- Gonzalez, Karen - Bellevue, Washington; August 24, 1999.
- Hall, Jim - City of Vancouver, British Columbia, Canada; July 15, 1999.
- Morris, Gerald - Clark County, Washington; January 6, 1999.
- Muller, Russ - Collier County, Florida; August 24, 1999.
- Paetzold, Max - Culver City, California; July 9, 1999.
- Parenti, Jeff - Brookline, Massachusetts; December 23, 1998.
- Rossman, Dave - City of Rochester, Minnesota; July 9, 1999.
- Schroll, Jim - Anne Arundel County, Maryland; July 2, 1999.
- Seiderman, Cara - Cambridge, Massachusetts; December 23, 1998.
- Walsh, Noreen - Boulder, Colorado; December 24, 1998.
- Watkins, Kathy - City of Cambridge, Massachusetts; July 9, 1999.

Local Surveys

The following municipal and county governments responded to surveys in the winter of 1998-99:

City of Albuquerque, New Mexico	City of Portland, Oregon
City of Appleton, Wisconsin	City of Rochester, Minnesota
City of Austin, Texas	City of Sacramento, California
City of Avon, California	City of San Jose, California
City of Bellevue, Washington	City of St. Paul, Minnesota
City of Berkeley, California	City of Tallahassee, Florida
City of Burlington, Vermont	City of Thousand Oaks, California
City of Cambridge, Massachusetts	City of Toledo, Ohio
City of Charlotte, North Carolina	City of Vail, Colorado
City of Columbus, Ohio	City of Vancouver, British Columbia
City of Culver City, California	City of West Palm Beach, Florida
City of Edwards, Washington	Town of Brookline, Massachusetts
City of Eugene, Oregon	Ada County, Idaho
City of Fort Wayne, Indiana	Anne Arundel County, Maryland
City of Gainesville, Florida	Arlington County, Virginia
City of Jacksonville, Florida	Clark County, Washington
City of Johnson, Tennessee	Collier County, Florida
City of Minneapolis, Minnesota	Gwinnett County, Georgia
City of Mobile, Alabama	Harford County, Maryland
City of Monterey, California	Howard County, Maryland
City of Orlando, California	King County, Washington
City of Phoenix, Arizona	Montgomery County, Maryland

Note: Although Seattle, Washington was not formally surveyed, they provided extensive data on their traffic calming program.

Statewide Pennsylvania Traffic Calming Survey

PennDOT conducted an on-line statewide calming survey between March and April 2011. The survey was completed to determine if traffic calming is being utilized, whether before and after studies were performed for specific devised, if policies have been adopted for requests for traffic calming devices, and if the Traffic Calming Handbook was utilized.

Survey Questionnaire

The following questions were presented in the on-line survey.

1. Has your municipality ever implemented a traffic calming project or adopted an ordinance, resolution or policy concerning traffic calming?

Yes or No

If you responded Yes please respond the following questions:

What other alternatives were considered prior to implementation and how did you decide on a traffic calming solution? _____

2. What materials were used as a guide to implement traffic calming decisions in your municipality?
 - 1) the PennDOT Publication 383 "Pennsylvania's Traffic Calming Handbook"
 - 2) Institute of Transportation Engineers (ITE) guidance
 - 3) Federal Highway Administration guidance
 - 4) Other (please specify)_____
3. Select which category best describes the ordinance, resolution or policy that you adopted on traffic calming:
 - A. No policy adopted nor any projects have been constructed within the municipality.
 - B. No policy was adopted, however a project was constructed.
 - C. The PennDOT recommended policy was adopted through ordinance, resolution or policy.
 - D. A more complicated policy was adopted through ordinance, resolution or policy
 - E. A more simplified policy was adopted

Please describe or attach a copy of your ordinance, resolution or policy that was adopted

Any additional comments?

4. In an effort to get an approximate inventory of Traffic Calming Devices in Pennsylvania, how many of the following traffic calming devices have been constructed in your municipality? (please respond to each device) See Publication 383 <ftp://ftp.dot.state.pa.us/public/PubsForms/Publications/PUB%20383.pdf> for photos and description of each device if needed. (Option of None, 1, 2, 3, or 4+ for each device)
 - A. Curb Extensions/Bulb-outs
 - B. Chicanes
 - C. Gateways
 - D. On-Street Parking
 - E. Raised Median/ Pedestrian Refuges
 - F. Traffic Circles
 - G. Roundabouts

- H. Textured Crosswalks
- I. Speed Humps
- J. Raised Crosswalks
- K. Raised Intersections
- L. Semi-Diverter
- M. Diagonal Diverter
- N. Right-in/Right-Out Island
- O. Raised Median Through Intersection
- P. Street Closures
- Q. Other Devices please describe _____

5. Have before and after studies been completed to determine the effectiveness of the traffic calming device(s)?

Yes or No.

If yes please describe the results, attach a file describing the results, or email the study or results to madepaoli@state.pa.us.

Any additional comments?

6. How would you describe your municipalities experience with traffic calming:

- A. Very Successful.
- B. Moderately Successful.
- C. Not successful at all.
- D. Not sure. Still reviewing the results.
- E. Please provide any comments on your experience _____

7. Have crash evaluations been completed after the implementation of the traffic calming solution(s) in your community?

Yes or No.

If yes, please describe the results of the evaluation and/or attach the evaluation. If you have trouble attaching the evaluation, please email to madepaoli@state.pa.us. Additionally, please provide any other feedback regarding safety affects after implementation in the text box below.

8. Please review the Traffic Calming Handbook (<ftp://ftp.dot.state.pa.us/public/PubsForms/Publications/PUB%20383.pdf>) and tell us what sections of the publication did you find to be:

- A. The most helpful?
- B. The least helpful?
- C. Lacking information?

Survey Results

A total of 382 municipalities participated in the on-line traffic calming survey. Of the 382 municipalities, only 60 municipalities, approximately 16 percent of the municipalities surveyed, had implemented traffic calming devices. These 60 municipalities were then directed to answer the remaining questions pertaining to the traffic calming survey.

Question 1: Traffic Calming Alternatives:

Alternatives that were considered by municipalities prior to implementation of traffic calming devices included speed enforcement, reduction of the speed limit, additional stop signs, street revisions (such as one-way roads and cul-de-sacs), adding pedestrian signage, and installing flashing speed limit signs. A total of 28 responses were collected on this topic. The following chart summarizes the type and number of responses.

Traffic Calming Alternatives

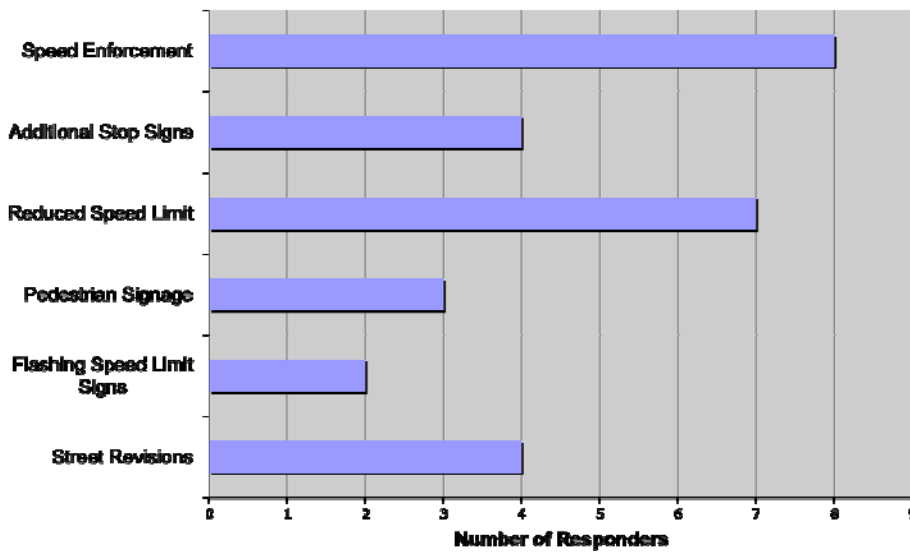

Question 1: Decision for Installation of Traffic Calming Devices:

The decision for install of traffic calming devices for the municipalities surveyed were determined through traffic studies, public input, lowest cost/realistic alternatives, recommendations from engineers, consultants, and PennDOT officials, and the board of commissioners or supervisors. A total of 29 responses were collected on this topic. The following chart summaries the decision to install traffic calming measures.

How the Decision for Traffic Calming Was Made

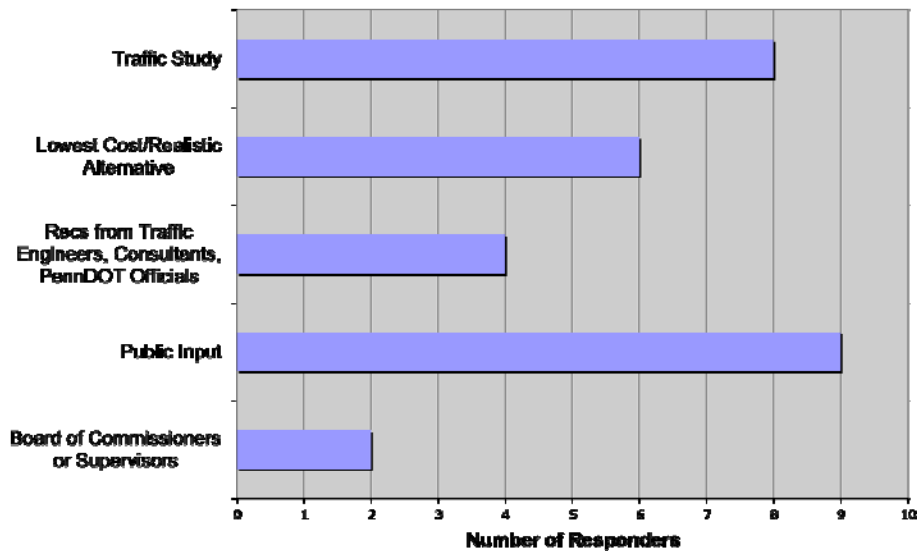

Question 2: Reference Materials Utilized in Traffic Calming Decision

The municipalities surveyed were asked to identify specific reference materials that were utilized in traffic calming decisions. Pennsylvania's Traffic Calming Handbook was identified by 36 municipalities, ITE guidance was identified by 15 municipalities, and FHWA guidance was identified by 9 municipalities. Some municipalities stated that they used outside consultants or that they did not know what was used. 24 (or 40%) of the municipalities that responded indicated that they did not use Pennsylvania's Traffic Calming Handbook. A total of 60 responses were collected on this topic. The following charts summarize the publications utilized versus the number of responses.

Reference Materials Utilized

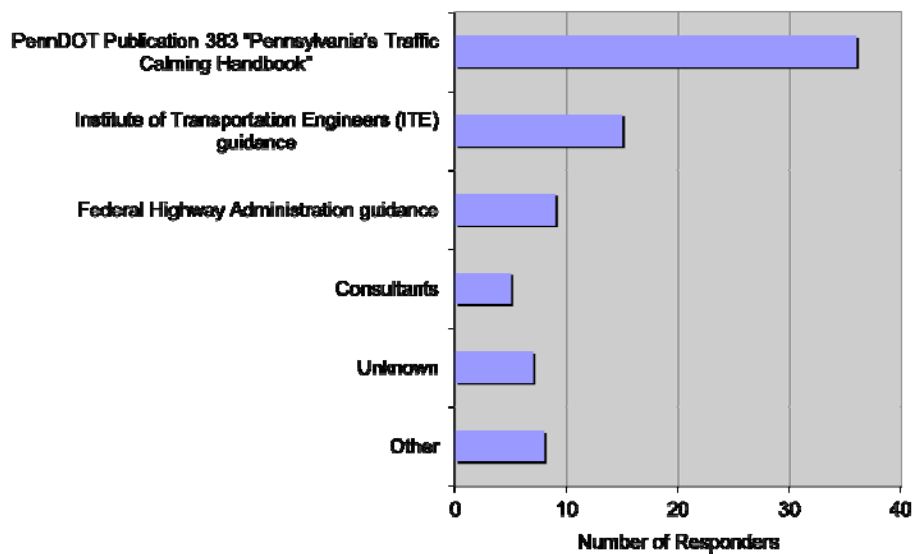

Percentage of Municipalities who used Pennsylvania's Traffic Calming Handbook

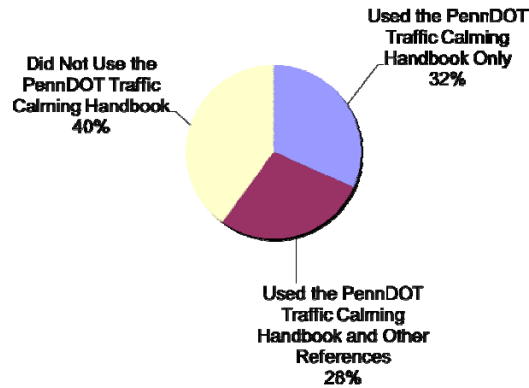

Question 3: Adopted Traffic Calming Policy

Municipalities were asked to comment on the type of traffic calming policy adopted. 151 (or 71%) of the responders indicated that no policy had been adopted nor had any traffic calming projects been constructed within the municipality. 37 (or 17%) of the responders indicated that no policy had been adopted, however a traffic calming project was constructed within the municipality. 12 (or 6%) of the responders indicated that the PennDOT recommended policy had been adopted through an ordinance, resolution or policy. 7 (or 3%) of the responders indicated that a more detailed policy was adopted, while 4 (or 2%) responded that a more simplified policy was adopted. Two of the municipalities indicated that their traffic calming policies were still under consideration at the time of the survey. A total of 213 responses were collected on this topic. The following chart summarizes the results of the type of traffic calming policy adopted.

Type of Policy Adopted on Traffic Calming

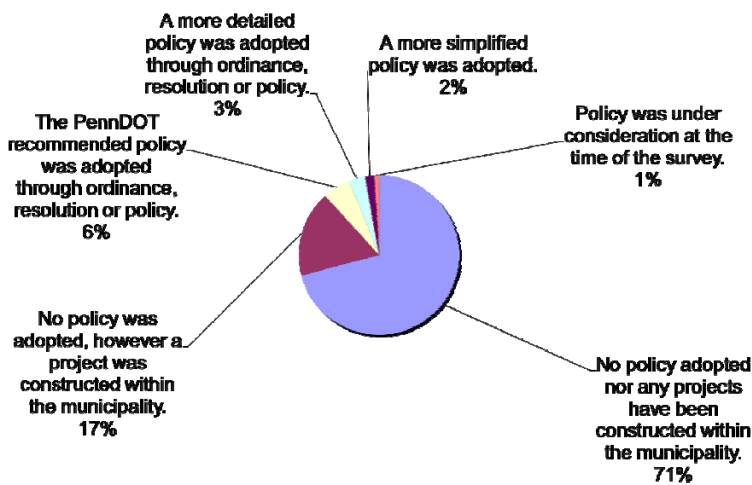

Question 4: Traffic Calming Devices Installed

Municipalities were asked to indicate the number and type of traffic calming devices installed in their area. The most popular devices included on-street parking, curb extensions/bulbouts, speed humps, raised medians/pedestrian refuges, and right-in/right-out islands. A list of devices in use and the approximate number of these devices existing within a municipality are provided in the chart below.

Traffic Calming Devices Installed

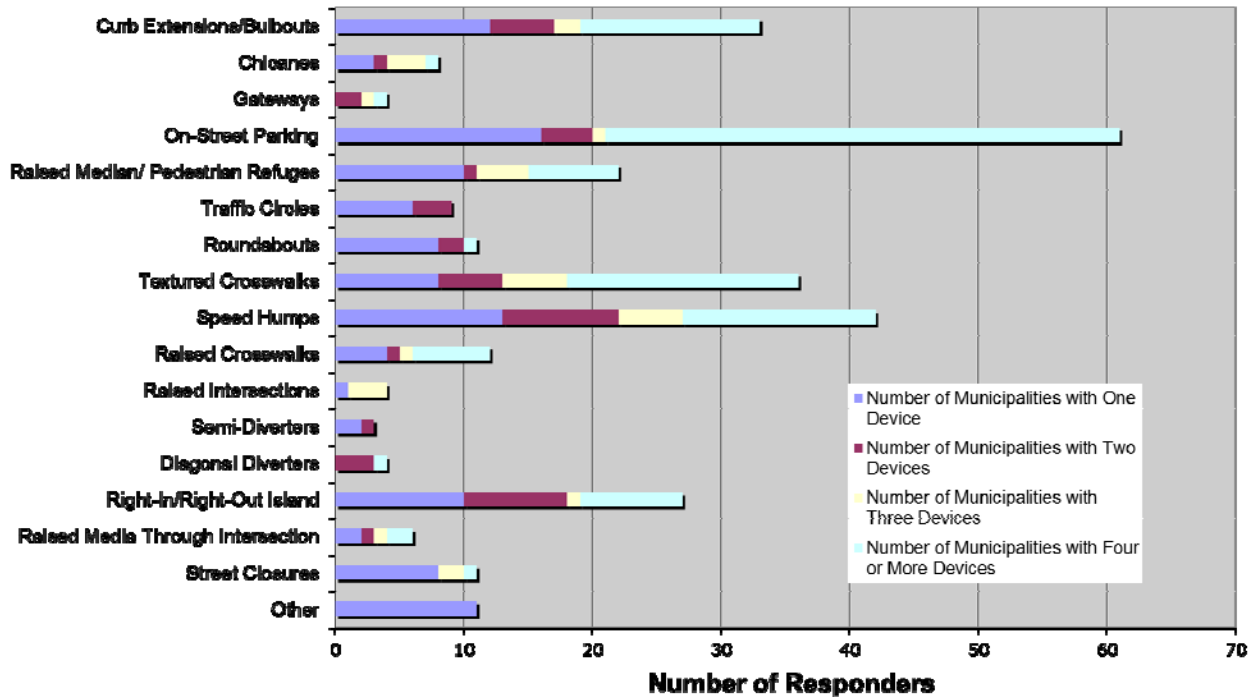

Questions 5 and 7: Follow-Up Traffic Calming Studies

The survey results indicate that very few municipalities have conducted studies on the effectiveness of their traffic calming devices. A total of 297 responses were collected on this topic. Out of the 297 responses, only 19 (or 6%) of the responders indicated that a before and after study had been completed to determine the effectiveness of the traffic calming devices installed in their area.

In addition, a total of 215 responses were collected on the topic of crash evaluation completed after the implementation of traffic calming. Out of the 215 responses, only 4 (or 2%) of the responders indicated that a crash evaluation had been completed after the implementation of traffic calming devices.

A follow-up study was provided by Patton Township, Centre County, Pennsylvania. The study was completed to determine the effectiveness of speed humps installed on Cricklewood Drive. According the information received, it was determined that 1) The overall traffic speeds were reduced when the speed humps are in place; 2) There was a much higher compliance with the speed limit when the speed humps were in place; and 3) The greatest compliance with the speed humps occurred when the speed humps re spaces close together.

The following table summarized the data obtained from Patton Township, Centre County, Pennsylvania.

Condition	Percent of Vehicles Traveling more than 26 mph
Without speed humps	85%
With humps spaced 500 feet apart	33%
With humps spaced 300 feet apart	15%

Question 6: Traffic Calming Experience

Municipalities were asked to evaluate their experiences with traffic calming. The majority of the responders (59 or 41%) indicated that they were still reviewing results and could not be sure. 20 (or 14%) of the responders indicated a very successful experience, 44 (or 31%) of the responders indicated a moderately successful experience, and 20 (or 14%) of responders indicated that their experience was not successful at all. A total of 143 responses were collected on this topic. The following chart summarizes Municipality's experience with traffic calming.

Traffic Calming Experience

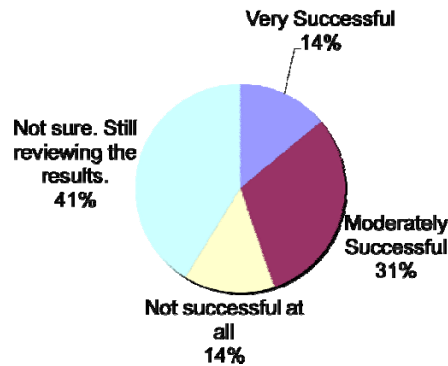

Question 8: Pennsylvania Traffic Calming Handbook Feedback

Municipalities were asked to review and comment on the information provided in *Pennsylvania's Traffic Calming Handbook*. 13 (or 20%) of the responders found the entire handbook to be helpful. A number of municipalities also identified Chapter 4 (Traffic Calming Study and Approval Process) and Chapter 5 (Traffic Calming Measures and Design Guidelines) to be the most helpful information provided in the handbook (10 and 12 responses, respectively). Other information that was found to be helpful to some municipalities included funding, legal issues, traffic calming issues, diagrams, pictures/descriptions, and individual device design elements. A total of 63 responses were collected on this topic. The following chart summarizes the most helpful information provided in the *Traffic Calming Handbook*.

Most Helpful Features in the Traffic Calming Handbook

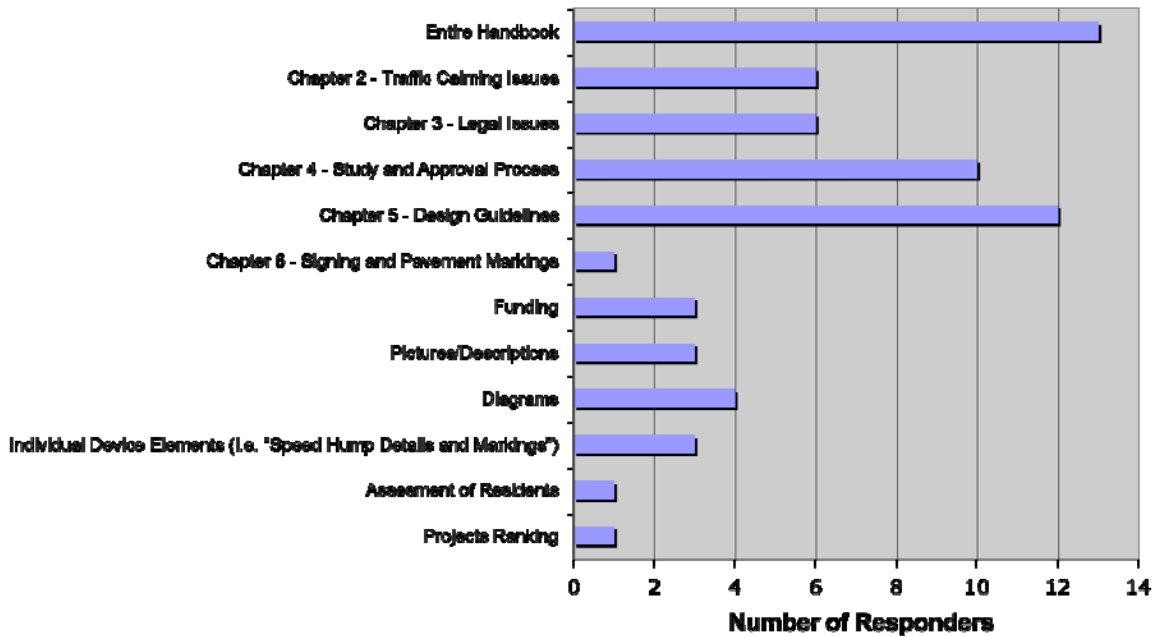

Some municipalities indicated that the least helpful information in Pennsylvania's Traffic Calming Handbook was the introduction and history (4 responders or 33%). Other information that was identified as being the least helpful included the study and approval process, funding, and street closures. 3 (or 25%) of the responders stated that they felt all of the information provided in the handbook was helpful. A total of 12 responses were collected on this topic. The following chart summarizes the least helpful information provided in the *Traffic Calming Handbook*.

Information that was felt to be lacking in the handbook included funding, and the use of signing and pavement markings. Overall, 4 (or 24%) of the responders felt that the handbook was not lacking any information. A total of 17 responses were collected on this topic. The following chart summarizes areas within the Handbooks that are considered lacking.

Least Helpful Features in the Traffic Calming Handbook

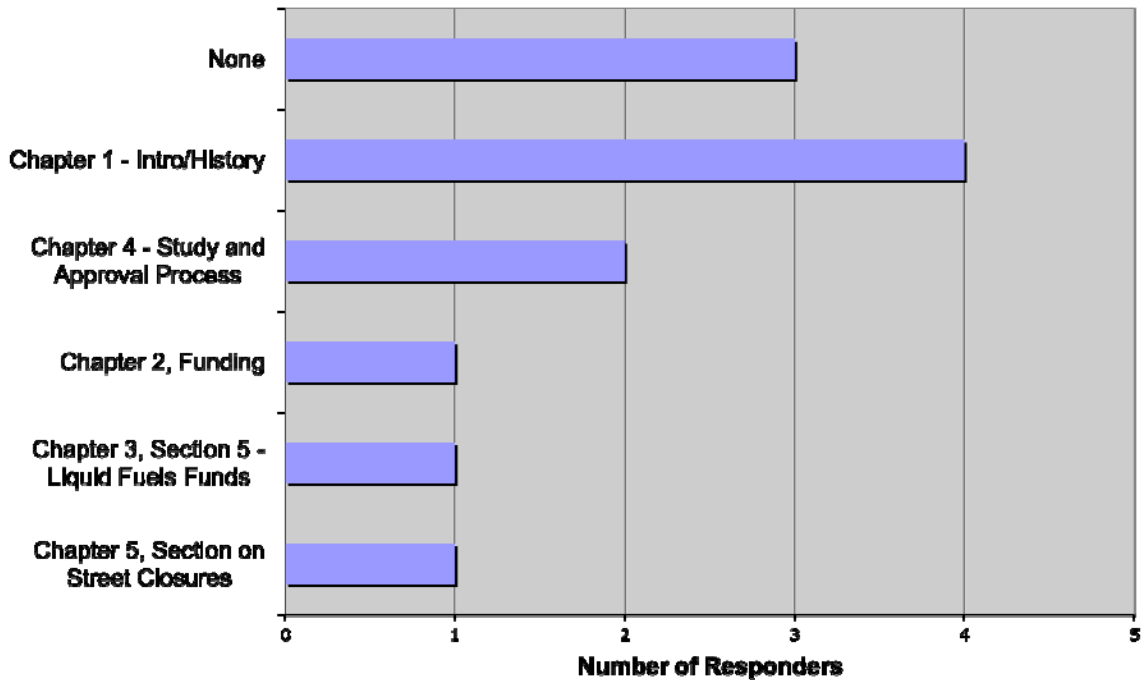

Information Lacking in the Traffic Calming Handbook

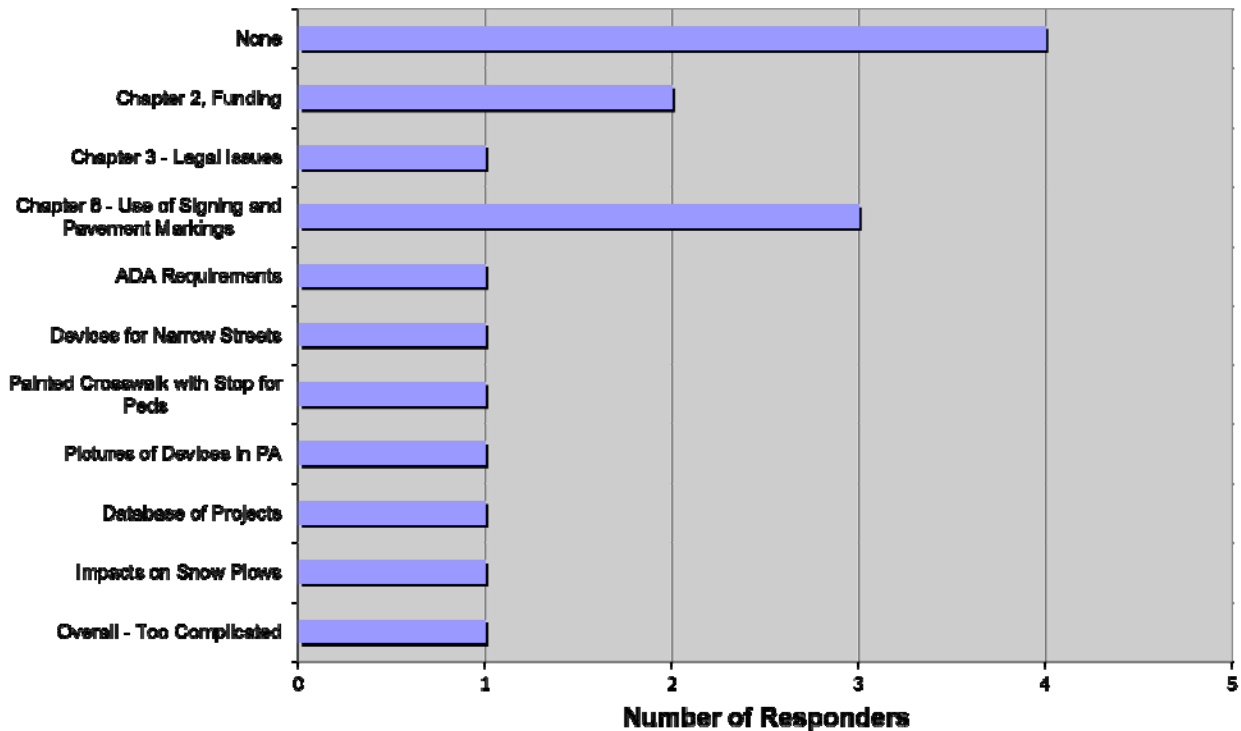

Summary of Survey

Based on the results of the survey, it was determined that only 16 percent of the municipalities surveyed have utilized traffic calming measures. Of the 16 percent, traffic calming alternatives were considered prior to the installation of traffic calming measures, with the majority utilizing speed enforcement and/or reduced speed limit signs.

The decision to install traffic calming measures was mainly determined through traffic studies and public input. The majority of the municipalities utilized the *Traffic Calming Handbook* and various other ITE references.

The municipalities concluded that Chapter 4, Traffic Calming Study and Approval Process, and Chapter 5, Traffic Calming Measures and Design Guidelines, were the most utilized and helpful sections of the *Traffic Calming Handbook*. However, the municipalities indicate that additional details on funding, signage, pavement markings, and effectiveness of devices would be deemed helpful.

State Surveys

The following state governments responded to surveys in the fall of 1998:

Alabama	Nevada
Alaska	New Jersey
California	New York
Colorado	North Dakota
Connecticut	Ohio
Florida	Oklahoma
Georgia	Oregon
Indiana	South Carolina
Louisiana	Tennessee
Kansas	Utah
Massachusetts	Maryland
Michigan	Virginia
Minnesota	Washington
Mississippi	West Virginia
Missouri	

Texts

Of the following list of texts, two stand out: ITE's *Traffic Calming State-of-the-Art*, and Transportation Association of Canada/Canadian ITE's *Canadian Guide to Neighbourhood Traffic Calming*. The former text is the most comprehensive work on the subject of traffic calming ever published in the United States. It should be recommended reading for anyone involved in the management of a traffic calming program. The latter work is also extremely comprehensive; although published in Canada, it refers to significant U.S. experience.

American Planning Association (APA), "Complete Streets: Best Policy and Implementation Practices", 2010.

Aspelin, Karen, et. al. "The North Albuquerque Acres Transportation Study." ITE Spring Conference. Tampa, Florida. March 1997.

Aspelin, Karen. "Recruiting Private Help for a Public Demonstration Project: Taking the 'Hump' out of Traffic Calming." ITE Spring Conference. Monterey, California. March 1998.

Atkins, Crysttal and Michael Coleman. "Influence of Traffic Calming on Emergency Response Times." *ITE Journal*. Washington, D.C. August 1997.

Ballard, Andrew J., P.E. "Speed Hump Effectiveness and Public Acceptance." ITE Fall Conference. Toronto, Ontario. August 1998.

Baston, Scott P.E., "Offset Speed Tables for Reduced Emergency Response Delay", City of Portland, OR. 2004.

Batty, Chris E., P.E. and Dean L. Cooper, P.E. "Potential for Neighborhood Self-Financing of Traffic Calming Measures." ITE Fall Conference. Toronto, Ontario. August 1998.

Berkeley, California, City of. *An Evaluation of the Speed Hump Program in the City of Berkeley*. Draft. October 1997.

Bretherton, W. Martin, Jr., P.E. "Multi-Way Stops – the Research Shows the MUTCD is Correct." ITE Spring Conference. Las Vegas, NV. 1999.

Castellone, Anthony J., P.E., Muhammed M. Hasan, P.E. "Neighborhood Traffic Management: Dade County, Florida's Street Closure Experience." *ITE Journal*. Washington, D.C. January 1998.

Champagne, Joseph S., P.E. "Traffic Calming—Potential Liabilities." ITE Spring Conference. Monterey, California. March 1998.

Chang, Kevin, Ph.D., P.E. and Nolan, Matthew, P.E., "An Evaluation of Speed Cushions on Neighborhood Streets: Balancing Emergency Vehicle Mobility with Traffic Calming Needs", 2005.

City of Alexandria, Virginia, "Neighborhood Traffic Calming Program Guide", 2002.

City of San Jose, California, "Traffic Calming Toolkit", 2001.

Coleman, Michael A. "The Influence of Traffic Calming Devices upon Fire Vehicle Travel Times." ITE Annual Meeting. Boston, Massachusetts. 1997.

Colyar, James. "Multnomah County, Oregon Street Design Standards Revision Study." ITE Spring Conference. Monterey, California. March 1998.

Cottrell, Benjamin H., Jr. "Using All-Way Stop Control for Residential Traffic Management." *Transportation Research Record* 1605. Transportation Research Board. Washington, D.C. 1998.

County of Sacramento, California, "Sacramento County Neighborhood Traffic Management Program (NTMP)", 2004.

County Surveyors' Society, et al. *Traffic Calming in Practice*. Landor Publishing Ltd. London. 1994.

Dabkowski, Jerry A. "Liabilities / Safety Issues with Traffic Calming Devices." ITE Spring Conference. Monterey, California. March 1998.

Daisa, James M., P.E., John B. Peers. "Narrow Residential Streets: Do They Really Slow Down Speeds?" ITE Spring Conference. Monterey, California. March 1998.

Dare, James W. and Noel F. Schoneman, P.E. "Seattle's Neighborhood Traffic Control Program." *ITE Journal*. Washington, D.C. February 1982.

Davis III, Raymond E., Gordon Lum. "Growing Pains or Growing Calmer? Lessons Learned from a Pilot Traffic Calming Program." ITE Spring Conference. Monterey, California. March 1998.

Dittberner, Randy A., P.E., "Achieving Support for Traffic Mitigation from Elected Officials and Emergency Services." ITE Fall Conference. Toronto, Ontario. August 1998.

Dittberner, Randy A., P.E. "Traffic Mitigation Success Stories in Phoenix." ITE Spring Conference. Las Vegas, NV. 1999.

Ewing, Reid, Charles Kooshian. "Traffic Calming Measures: What, Why, Where, and How." Transportation Research Board Annual Meeting. Washington, D.C. 1998.

Ewing, Reid, Charles Kooshian. "U.S. Experience with Traffic Calming." *ITE Journal*. Washington, D.C. August 1997.

Ewing, Reid. "Traffic Calming in New Developments (or Avoiding the Need for Future Fixes)." Transportation Research Board Annual Meeting. Washington, D.C. January 1999.

Ewing, Reid, and Charles Kooshian. Institute of Transportation Engineers. *Traffic Calming State-of-the-Art*. Washington, D.C. Draft report. February 1999.

Folkers, Richard J., P.E. "Political Aspects of Traffic Calming." ITE Spring Conference. Monterey, California. March 1998.

Federal Highway Administration, *Manual on Uniform Traffic Control Devices*, 2009.

Federal Highway Administration, *Pilot Test of Heed the Speed, A Program to Reduce Speeds in Residential Neighborhoods*, 2006.

Federal Highway Administration, *Speed Management Strategic Initiative*, 2005.

Federal Highway Administration, *Traffic Calming on Main Roads Through Rural Communities*, 2009.

Giese, Joni L., Gary A. Davis, Robert D. Sykes. "The Relationship Between Residential Street Design and Pedestrian Safety." ITE Annual Meeting. Boston, Massachusetts. 1997.

Gonzalez, Karen. "Neighborhood Traffic Control: Bellevue's Approach." *ITE Journal*, May 1993.

Gorman, Michael N., Massoum Moussavi, Patrick T. McCoy. "Evaluation of Speed Hump Program in the City of Omaha." *ITE Journal*. Washington, D.C. June 1989.

Hanneman, Martin, P.E., Brook Ostrom, Steve Fitzsimons, P.E. "Three Perspectives on Traffic Calming." ITE Spring Conference. Monterey, California. March 1998.

Hillsborough County Public Works Department, Florida, "Hillsborough County Florida Neighborhood Traffic Calming Manual", Hillsborough, Florida January 16, 2003.

Homburger, Wolfgang S., et al. Institute of Transportation Engineers. *Residential Street Design and Traffic Control*. Englewood Cliffs, New Jersey: Prentice Hall, 1989.

Huffine, Charles W, P.E., A.I.C.P., P.T.O.E., "Kodak Park Neighborhood Traffic Management", 2001.

Institute of Transportation Engineers. *Guidelines for the Design and Application of Speed Humps, Recommended Practice RP-023A*. Washington, D.C. June 1997.

Institute of Transportation Engineers and Federal Highway Administration, *Traffic Calming: State of the Practice*, 1999.

Institute of Transportation Engineers, "Traffic Calming Practice Revisited", ITE Journal, November 2005.

Kant, Edward J., P.E. and Russell D. Miller. "Neighborhood Traffic Management: Development and Implementation." ITE 1997 International Conference.

Kastenhofer, Elona Orban. "Traffic Calming, the Helpful Band-Aid, in Virginia When the State DOT is 100+ Local DPW." ITE Annual Meeting. Boston, Massachusetts. 1997.

Keck, J. Kevin. "Caught in the Middle—the Fight for Narrow Residential Streets." ITE Spring Conference. Monterey, California. March 1998.

Lockwood, Ian M. "ITE Traffic Calming Definition." *ITE Journal*. Washington, D.C. July 1997.

Lockwood, Ian M and Timothy Stillings. "Meeting Community Objectives through Street Design (The West Palm Beach Approach)." ITE Spring Conference. Monterey, California. March 1998.

Lockwood, Ian M., Timothy Stillings. "Traffic Calming for Crime Reduction and Neighborhood Revitalization." ITE Fall Conference, Toronto, Ontario. August 1998.

Lum, Harry S. "The Use of Road Markings to Narrow Lanes for Controlling Speed in Residential Areas." *ITE Journal*, May 1984.

Macbeth, Andrew G. "Calming Arterials in Toronto." ITE Fall Conference, Toronto, Ontario. August 1998.

McCourt, Ransford S. "Survey of Neighborhood Traffic Management Performance and Results." ITE Spring Conference. Monterey, California. March 1998.

McMillian, Susan, City of Houston, Texas, "Calming Houston's Traffic," ITE Annual Meeting. Boston, Massachusetts. 1997.

Minnesota Department of Transportation. "Traffic Calming Activity in Minnesota." December 1997.

Mulder, Kathy. "Split Speed Bumps: Traffic Calming for Emergency Response." *ITE Journal*. Washington, D.C. February 1998.

Murphy, Robert P. and Gillian Fishbach. "Policies for Residential Traffic Control in Brentwood, Tennessee." ITE Spring Conference, Tampa, Florida. March 1997.

New Jersey Department of Transportation and the Pennsylvania Department of Transportation, *Smart Transportation Guidebook*, March 2008.

North Central Institute of Transportation Engineers. *Neighborhood Traffic Control*. December 1994.

Oregon Department of Transportation, *Update and Enhancement of ODOT's Crash Reduction Factors*, 2008.

Placer County Department of Public Works, California, *Placer County Neighborhood Traffic Management Program*, February 28, 2007.

Ponnaluri, Raj V P.E. and Paul W Groce, "Operational Effectiveness of Speed Humps in Traffic Calming", ITE Journal, July 2005.

- Route 50 Corridor Coalition. *A Traffic Calming Plan for Virginia's Rural Route 50 Corridor*. Middleburg, Virginia. 1996.
- Richardson, Emmerson. "Traffic Calming the City Centre: the Fremantle Experience." ITE Fall Conference. Toronto, Ontario. August 1998.
- Schoneman, Noel F., P.E. "Low Cost vs. High Cost Traffic Calming Devices in Seattle." ITE Fall Conference, Toronto, Ontario, 1998.
- Skene, Mike, *et al.* "Developing a Canadian Guide to Traffic Calming." *ITE Journal*. Washington, D.C. July 1997.
- Skene, Michael. "'Traffic Calming' on Arterial Roadways?" ITE Spring Conference, Las Vegas, NV. 1999.
- Smith, Daniel J, Dr. Keith Knapp, and Dr. Shauna Hallmark. "Speed Impacts of Temporary Speed Humps in Small Iowa Cities".
- South Carolina Department of Transportation, *Traffic Calming Guidelines*, 2006.
- Szplett, David and Michael Fuess. "Designing Speed Controlled Subdivisions Without Road Humps." ITE Spring Conference, Las Vegas, NV. 1999.
- Szplett, David, and Larry Sale. "Some Challenges in Developing Neotraditional Neighborhood Designs." *ITE Journal*. Washington, D.C. July 1997.
- Transportation Association of Canada and Canadian Institute of Transportation Engineers. *Canadian Guide to Neighbourhood Traffic Calming*. August 1998.
- Transportation Research Board, *Speed Management Techniques for Collectors and Arterials*.
- Tobin, John R., P.E. "Standards and Guidelines for Mid-Block Crossings: Las Vegas Study." ITE Spring Conference. Las Vegas, NV. 1999.
- Urban, Carlton, P.E. "Calming Neighborhood Traffic with Speed Humps: Comparing Policies and Programs in Metro Atlanta." ITE Spring Conference, Las Vegas, NV. 1999.
- Virginia Department of Transportation, "Residential Traffic Calming Guide: Pilot Program, January 1998 – December 1999." December 1997.
- Virginia Department of Transportation, *Traffic Calming Guide for Local Residential Street*, 2008.
- Washington State Department of Transportation. *A Guidebook for Residential Traffic Management*. December 1994.
- Wainwright, W. Scott, P.E. "Montgomery County's Speed Hump Program – A Love-Hate Story." ITE Fall Conference. Toronto, Ontario. August 1998.
- Walter, C. Edward. "Suburban Residential Traffic Calming." *ITE Journal*. Washington, D.C. September 1995.
- Weinstein, Asha, and Elizabeth Deakin, University of California at Berkeley, Department of City and Regional Planning. "How Local Jurisdictions in the United States Finance Traffic Calming." Transportation Research Board Annual Meeting, Washington, D.C. January 1999.

Web Sites

Boulder, Colorado, City of: www.bouldercolorado.gov

Charlotte, North Carolina, City of: <http://charmeck.org/Pages/default.aspx>

Portland, Oregon, City of: <http://www.portlandonline.com/>

Toronto, Ontario, City of: <http://www.toronto.ca/>

www.trafficcalming.org

Appendix C

TRAFFIC CALMING EFFECTIVENESS STUDIES

Patton Township in Centre County, PA

A study was conducted in 2000 in Patton Township, Centre County, PA to determine the effectiveness of speed humps on Cricklewood Dr. According to information received from the township about the study, it was determined that:

- Overall traffic speeds are reduced when the humps are in place.
- There is much higher compliance with the speed limit when the humps are in place.
- Compliance with the speed limit is highest when the humps are spaced closer together.

The following table (received in an email from the Patton Township Manager) summarizes the data obtained during the study.

Condition	Percent of Vehicles Traveling more than 26 mph
Without speed humps	85%
With humps spaced 500 feet apart	33%
With humps spaced 300 feet apart	15%

Florida

Five speed humps were installed on a residential street in Polk County, FL. Traffic volume data and speed data was collected both before and one month after speed hump installation. The following table was taken from *Operational Effectiveness of Speed Humps in Traffic Calming* (Ponnaluri) and shows the comparison of this information.

Table 1. Pre- and post-installation data comparison.

Dorman Road	Between Schoolhouse Road and Serrento				Between Serrento and Nestlewood Court				Between Nestlewood Court and West Pipkin Road			
	Pre	Post	Δ	% Δ	Pre	Post	Δ	% Δ	Pre	Post	Δ	% Δ
Characteristics												
<i>Volume measure</i>												
Average day	1,562	1,104	-458	-29	1,297	1,237	-60	-5	1,661	1,422	-239	-14
<i>Speed measures (mph)</i>												
Mean	35	24	-11	-31	22	23	1	5	29	22	-7	-24
Median	33	24	-9	-27	22	23	1	5	30	22	-8	-27
85th percentile	41	29	-12	-29	37	29	-8	-22	38	27	-11	-29
10 mph pace	31-40	21-30	-10		26-35	21-30	-5		26-35	16-25	-10	
Percent in pace	52.2	71.4	19.2	37	58.6	67.8	9.0	16	45.5	76.2	30.7	67
Percent over posted speed	91.1	30.1	-61.0	-67	75.0	32.0	-43.0	-57	71.3	16.1	-55.2	-77

Iowa

A study was conducted in Atlantic, IA to study the impact of speed humps and speed tables on vehicle speed profiles in rural areas. Speed profiles were collected before the temporary installation of traffic calming devices, during the implementation of a speed hump, during the implementation of a speed table, and after the traffic calming devices were removed. The following table was taken from *Speed Impacts of Temporary Speed Humps in Small Iowa Cities* (Smith), and summarizes the results of the study.

Table 9. Peak Speed Summary.

Roosevelt Drive				
Peak Speed (mph)	Before (% of vehicles)	Speed Hump (% of vehicles)	Speed Table (% of vehicles)	After (% of vehicles)
<20	0.0%	11.0%	14.8%	13.3%
20-25	31.9%	47.6%	51.9%	36.7%
26-30	50.0%	28.0%	33.3%	30.0%
31-35	13.9%	11.0%	0.0%	10.0%
>35	4.2%	2.4%	0.0%	10.0%

Redwood Drive				
Peak Speed (mph)	Before (% of vehicles)	Speed Hump (% of vehicles)	Speed Table (% of vehicles)	After (% of vehicles)
<20	2.5%	15.9%	14.0%	0.0%
20-25	32.5%	39.7%	52.7%	37.0%
26-30	45.0%	36.5%	31.2%	50.0%
31-35	15.0%	6.3%	2.1%	13.0%
>35	5.0%	1.6%	0.0%	0.0%

Massachusetts

Data was collected by the City of Newton, Massachusetts. The following table details traffic calming Impacts on speed, volume and safety of various devices.

	Sample size(feet)	% Average speed decrease	% average change in collision	% average change in volume
Speed hump	12	20	11	N.D.
Speed table	22	18	45	N.D.
Raised crosswork	22	18	45	N.D.
Raised intersection	N.A.	1	N.D.	N.D.
Textured Pavement	N.A.	N.D.	N.D.	N.D.
Traffic Circles	N.A.	11	27	N.D.
Roundabouts	N.A.	More higher speeds	29	N.D.
Chicanes	N.A.	N.D.	N.D.	N.D.
Realigned intersections	N.A.	N.D.	N.D.	N.D.
Neckdowns	N.A.	4	N.D.	N.D.
Medians and Center Island Narrowings	N.A.	4	N.D.	N.D.
Full closure	N.A.	44	N.D.	N.D.
Median barriers	N.A.	31	N.D.	N.D.
Half closure	N.A.	42	N.D.	N.D.
Forced Turn Island	N.A.	31	N.D.	N.D.
Diagonal Diverter	N.A.	35	N.D.	N.D.

N.A. (Not Available), N.D. (No Data)

New York State

Speed humps were implemented in Rochester, NY in 2000 with the intention of reducing volumes on two diversion routes. In 2001, a follow-up study was conducted to evaluate the effectiveness of the traffic calming devices. The following charts were taken from *Kodak Park Neighborhood Traffic Management* (Huffine) and show the results. The city considered the project a success.

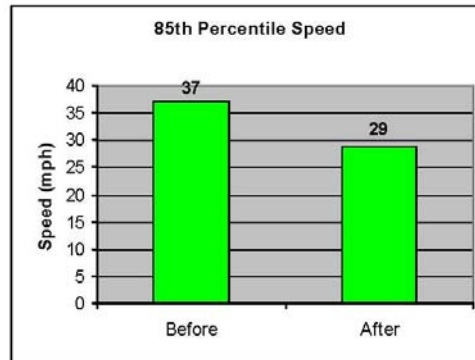
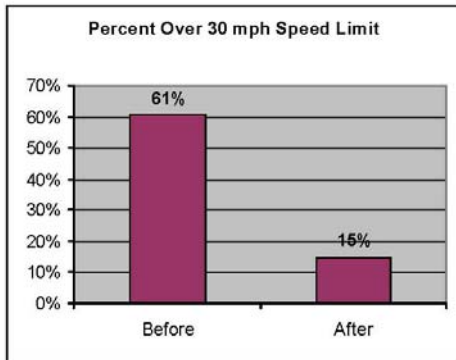
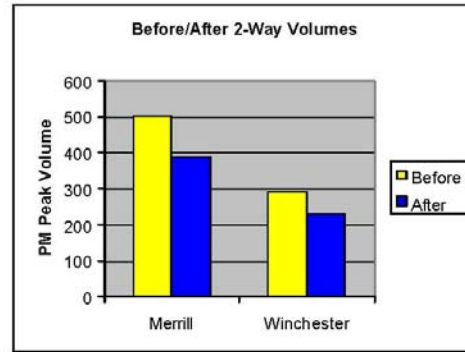
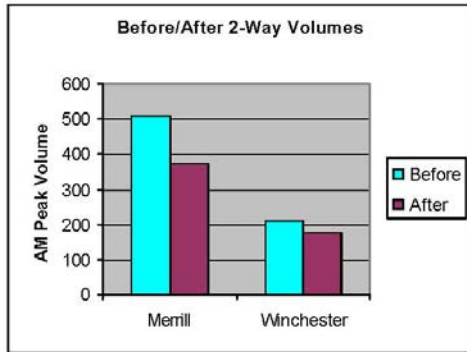

Oregon

Several streets in Portland, Oregon which have traffic calming devices were reviewed for the occurrence of collisions. A summary of collision investigation for various traffic calming measures (traffic circles, 22ft speed bumps, and 14ft speed bumps), prepared by the City of Portland, Oregon in August 1997 are presented below.

As shown in the table below, speeds along the roadways decrease an average of 4 miles per hour (mph) with the implementation of traffic circles. The traffic circles were also implemented to divert traffic at two (2) study locations. Based on the results, these locations resulted in an average decrease in traffic of approximately 460 vehicles per day. All other study locations indicated that the traffic circles reduced traffic on average by approximately 520 vehicles per day. The traffic circles resulted in a reduced number of reported collisions and number of collisions per 1000 vpd, 30.19 percent and 3.60 percent, respectively.

Speeds along the roadways decrease an average of 9 miles per hour (mph) with the implementation of 14 foot speed bumps. The 14 foot speed bumps were also implemented to divert traffic at one (1) study location. This location resulted in an average decrease in traffic of approximately 2500 vehicles per day. All other study locations indicated that the 14 foot speed bumps reduced traffic on average by approximately 145 vehicles per day. The 14 foot speed bumps resulted in a reduced number of reported collisions and number of collisions per 1000 vpd, 39.34 percent and 2.02 percent, respectively.

Likewise, speeds along the roadways decrease an average of 8 miles per hour (mph) with the implementation of 22 foot speed bumps. The 22 foot speed bumps reduced traffic on average by approximately 1270 vehicles per day. The 22 foot speed bumps resulted in a reduced number of reported collisions and number of collisions per 1000 vpd, 35.71 percent and 4.01 percent, respectively.

Summary of Collisions Investigation for Various Traffic Calming Devices

Project Street	Street Class	Street Length (ft)	Traffic Speed Devices	Diversion Intended	Speed (mph)		ADT		Reported Collisions		Period (months)	Collisions/1000 vpd			
					Pre	Post	Pre	Post	Pre	Post		Pre	Post	% Change	
NE 7th Avenue	LS	4300	5 Circles	N	36-40	32	6500	5500	55	30	36	8.46	5.45	-35.54%	
SE Clinton Street on (1)	LS	6200	4 Circles	Y	37	33	2400	2000	145	116	52	60.42	58.00	-4.00%	
SE Clinton (2)	LS	2900	4 Circles	Y	36	32	1200	680	35	20	52	29.17	29.41	0.84%	
NE Holman	LS	2600	3 Circles	N	32-34	31-34	1400	1100	30	29	74	21.43	26.36	23.03%	
NE 21st	LS	1700	2 Circles	N	34	30	5600	5600	9	8	61	1.61	1.43	-11.11%	
NE 24th	LS	2000	3 Circles	N	36	29	3500	3200	19	6	61	5.43	1.88	-65.46%	
NW 25th	LS	1500	3 Circles	N	33	28	7800	6500	25	12	76	3.21	1.85	-42.40%	
NW Raleigh	LS	1500	2 Circles	N	30	26	2100	1500	0	1	76	0.00	0.67	-	
									Circle Total	318	222		129.71	125.05	
									% Change	-30.19%		% Change	-3.60%		

Project Street	Street Class	Street Length (ft)	Traffic Speed Devices	Diversion Intended	Speed (mph)		ADT		Reported Collisions		Period (months)	Collisions/1000 vpd		
					Pre	Post	Pre	Post	Pre	Post		Pre	Post	% Change
N Macrum	LS	2280	7 14ft Bumps	N	32-34	20-26	480	370	4	3	41	8.33	8.11	-2.70%
NE Pacific	LS	1400	4 14ft Bumps	N	34	24	600	600	10	11	41	16.67	18.33	10.00%
NE 108th	LS	1000	2 14ft Bumps	N	32	23	770	700	5	3	41	6.49	4.29	-34.00%
SE 55th	LS	1600	4 12ft Bumps	N	26-37	21-25	2300	1900	13	4	41	5.65	2.11	-62.75%
SW Boones Ferry	LS	3000	5 14ft Bumps	Y	28-35	23-26	4000	1500	29	16	28	7.25	10.67	47.13%
							14 ft Bump Total		61	37		44.40	43.50	
									% Change	-39.34%		% Change	-2.02%	
NW Cornell	NC	3200	4 22ft Bumps	N	32-40	28-32	6500	6400	1	2	29	0.15	0.31	
NE 15th (1)	NC	2300	3 22ft Bumps	N	35-40	25-30	8440	6780	16	8	15	1.90	1.18	-37.76%
NE 15th (2)	NC	2200	4 22ft Bumps	N	35-40	25-30	8440	6780	27	16	26	3.20	2.36	-26.23%
SE Harold	LS	5000	8 22ft Bumps	N	37-40	30-34	4210	2550	12	10	15	2.85	3.92	37.58%
							22 ft Bump Total		56	36		8.10	7.77	
									% Change	-35.71%		% Change	-4.01%	

Appendix D

EXAMPLE TRAFFIC CALMING POLICIES

Traffic calming policies implemented by the following municipalities and townships have been included:

- East Norriton Township, Montgomery County, Pennsylvania
- Findlay Township, Allegheny County, Pennsylvania
- Middletown Township, Bucks County, Pennsylvania
- Moon Township, Allegheny County, Pennsylvania
- Municipality of Mount Lebanon, Allegheny County, Pennsylvania
- Peters Township, Washington County, Pennsylvania
- State College Borough, Centre County, Pennsylvania
- Upper St. Clair Township, Allegheny County, Pennsylvania
- Warminster Township, Bucks County, Pennsylvania

To view the policies follow this link:

<ftp://ftp.dot.state.pa.us/transfer/Traffic%20Signals/Pub.%20383/Pub%20383%20Appendix%20D.pdf>