

OS-299 (11-13)



**pennsylvania**  
DEPARTMENT OF TRANSPORTATION  
www.dot.state.pa.us

## TRANSMITTAL LETTER

PUBLICATION:

46

DATE:

March 3, 2014

SUBJECT:

Traffic Engineering Manual - Change 1

### INFORMATION AND SPECIAL INSTRUCTIONS:

Updates the Table of Contents

This change incorporates SOL 494-13-03 Issuance of New Chapters 10 & Revised 12

This change incorporates SOL 494-13-12 Revisions to Logo Program

Miscellaneous revisions throughout Chapter 2

### CANCEL AND DESTROY THE FOLLOWING:

Table of Contents destroy and insert revised  
Chapter 2 destroy and insert revised chapter  
Chapter 10 Insert new chapter  
Chapter 12 destroy and insert revised chapter

### ADDITIONAL COPIES ARE AVAILABLE FROM:

- PennDOT SALES STORE  
(717) 787-6746 phone  
(717) 525-5180 fax  
ra-penndotsalesstore@pa.gov
- PennDOT website - [www.dot.state.pa.us](http://www.dot.state.pa.us)  
*Click on Forms, Publications & Maps*
- DGS warehouse (PennDOT employees ONLY)

### APPROVED FOR ISSUANCE BY:

  
Richard Roman, P.E.  
Director  
Bureau of Maintenance & Operations

# TRAFFIC ENGINEERING MANUAL



**Bureau of Maintenance and Operations**



PUB 46 (2-12)

There are hyperlinks throughout this document that should provide network connections to other publications, regulations, Vehicle Code, etc. There are also hyperlinks that reference other sections, exhibits, or appendices within this manual, and these should assist you in navigating.

Although not obvious by their color, the Table of Contents and the List of Exhibits also work as hyperlinks. Simply, left click on the section or exhibit number, title, or page number and your computer should take you to the proper page.

You may also find the bookmarks on the left side of the screen helpful.

**TABLE OF CONTENTS**

**CHAPTER 1 - GENERAL.....1-1**

1.1 OVERVIEW ..... 1-1

*Purpose* ..... 1-1

*State and Federal Mandates* ..... 1-1

*Principles of Traffic Control Devices*..... 1-2

*Engineering Study and Engineering Judgment*..... 1-2

*Requests to Experiment with Unique Traffic Control Devices* ..... 1-2

*Older Drivers* ..... 1-3

*Applicability of the MUTCD* ..... 1-4

*Acceptable Abbreviations for Use on Traffic Control Devices* ..... 1-4

*Proprietary Items*..... 1-4

*Laws, Regulations, Forms and Other Publications* ..... 1-5

*Definitions*..... 1-10

1.2 CHAPTER 1 APPENDIX ..... 1-14

*Proprietary Item Approval Request Sample Letter*..... 1-14

*Access Route Approval – Expanded Access* ..... 1-16

*References*..... 1-16

*Background*..... 1-16

*PROCEDURE FOR EXPANDED ACCESS* ..... 1-16

**CHAPTER 2 - SIGNING.....2-1**

2.1 SIGNING OVERVIEW ..... 2-1

*Purpose* ..... 2-1

*Classification of Signs*..... 2-1

*Design of Signs*..... 2-1

*Minimum Retroreflectivity*..... 2-4

*Enhanced Conspicuity for Signs* ..... 2-5

*Recouping Costs Incurred from Crashes* ..... 2-6

*Laws, Regulations, and Other Publications* ..... 2-6

2.2 OFFICIAL SIGNS AND APPROVED SIGN MANUFACTURERS ..... 2-7

*Official Signs*..... 2-7

*Approved Sign Manufacturers*..... 2-7

2.3 APPROVAL AND ERECTION RESPONSIBILITIES ..... 2-7

*Signing Responsibilities*..... 2-7

*Signs Erected by Others* ..... 2-10

*Issuance of Sign Work Orders*..... 2-10

2.4 REGULATORY SIGNS ..... 2-10

*Requirement for Engineering and Traffic Study* ..... 2-10

*Establishment of Priorities*..... 2-10

*STOP Sign Installations* ..... 2-11

*Signing Responsibilities at Intersections with Local Roads* ..... 2-11

*Posting Regulatory Speed Limits* ..... 2-11

*PASS WITH CARE Signs* ..... 2-12

*ONE-WAY Sign Installations* ..... 2-13

*Weight Limits*..... 2-13

*Signing on Lower-Volume Roads*..... 2-14

2.5 WARNING SIGNS ..... 2-15

*General*..... 2-15

*Advance Placement of Warning Signs*..... 2-16

<i>Signing Curves and Turns</i> .....	2-17
<i>Stop Ahead Signs</i> .....	2-21
<i>Share the Road Sign</i> .....	2-21
<i>Advance Street Name Signs</i> .....	2-22
2.6    GUIDE SIGNS AND ROUTE MARKERS .....	2-23
<i>General</i> .....	2-23
<i>Definitions</i> .....	2-24
<i>Clearview Font</i> .....	2-26
<i>Numbered Traffic Routes</i> .....	2-27
<i>Route Marker Assemblies</i> .....	2-29
<i>Additional Route and Destination Guidance Signs</i> .....	2-31
<i>Longitudinal Placement</i> .....	2-32
2.7    TOURIST ORIENTED DIRECTIONAL SIGNS (TODS) POLICY .....	2-34
<i>Purpose, Authority, and Authorization</i> .....	2-34
<i>Definitions</i> .....	2-35
<i>General Eligibility Requirements</i> .....	2-36
<i>Additional Eligibility Requirements</i> .....	2-37
<i>Eligible Types of Participants</i> .....	2-38
<i>Location, Spacing, and Design of TODS for Conventional Roads</i> .....	2-42
<i>Sign Installation, Cost and Maintenance</i> .....	2-44
<i>Seasonal Participants</i> .....	2-45
<i>Removal of a TODS</i> .....	2-45
<i>Application Procedure</i> .....	2-46
<i>Signing Districts</i> .....	2-47
2.8    ACKNOWLEDGEMENT SIGNS.....	2-52
<i>General Requirements</i> .....	2-52
<i>Adopt-A-Highway Signs</i> .....	2-53
<i>Beautification Area Signs</i> .....	2-53
<i>Sponsor-a-Highway</i> .....	2-53
2.9    OPERATIONAL CHANGES REQUIRING TRANSITIONAL SIGNING .....	2-53
<i>General Discussion of Operational Changes</i> .....	2-53
<i>Reversing STOP Signs</i> .....	2-54
<i>Four-Way to Two-Way Stop Control</i> .....	2-54
<i>One-Way to Two-Way Street Operation</i> .....	2-54
<i>Two-Way to One-Way Street Operation</i> .....	2-55
<i>One-Way Street Reversal</i> .....	2-55
<i>Revised Exit Numbers</i> .....	2-55
2.10   MISCELLANEOUS SIGNS .....	2-56
<i>Anti-Littering Signs</i> .....	2-56
<i>Coffee Break Signs</i> .....	2-56
<i>Historical Markers</i> .....	2-57
<i>Library Signs</i> .....	2-57
<i>Memorial Markers</i> .....	2-57
<i>Motorist Alert Signs</i> .....	2-59
<i>Municipal Name Signs</i> .....	2-59
<i>Recreational and Cultural Interest Symbol Signs</i> .....	2-60
<i>Recycling Program Signs</i> .....	2-60
<i>Scenic River Signs</i> .....	2-61
<i>Signs and Banners across State Highways</i> .....	2-61
<i>SR and Segment Markers</i> .....	2-62
<i>Street Name Signs</i> .....	2-63
<i>Welcome to Pennsylvania Signs</i> .....	2-63

<i>Wildflower Area Signs</i> .....	2-63
<i>Object Markers</i> .....	2-65
2.11 EXCESSIVE USE OF SIGNS .....	2-65
<i>Sign Clutter</i> .....	2-65
<i>Double Stop Signs</i> .....	2-65
<i>Sign Grouping</i> .....	2-65
2.12 STANDARD FREEWAY AND EXPRESSWAY SIGNS .....	2-65
<i>Standards and Approvals</i> .....	2-65
<i>Selection of Major Destinations</i> .....	2-66
<i>Selection of Supplemental Destinations</i> .....	2-68
<i>Motorist Service Signs</i> .....	2-69
<i>Reference Location and Enhanced Reference Location Signs</i> .....	2-69
<i>Intermediate Reference Location Signs</i> .....	2-70
<i>Interchange Numbering</i> .....	2-71
<i>Overhead Signs</i> .....	2-72
<i>Upgrading Temporary Signs</i> .....	2-72
<i>Overpass Roadway Identification Signs</i> .....	2-72
<i>Public Relations</i> .....	2-72
2.13 GENERAL MOTORIST SERVICE SIGNS .....	2-72
<i>Purpose and Authorization</i> .....	2-72
<i>Definitions</i> .....	2-72
<i>Acceptable Types of Motorist Services</i> .....	2-73
<i>Additional Criteria</i> .....	2-74
<i>Sign Location</i> .....	2-74
<i>Design of New Installations</i> .....	2-75
<i>Procedures for Application</i> .....	2-75
2.14 LOGO PROGRAM .....	2-77
<i>Purpose</i> .....	2-77
<i>Authority</i> .....	2-77
<i>Administration</i> .....	2-77
<i>Definitions</i> .....	2-77
<i>Types of Services</i> .....	2-78
<i>Distance to Services</i> .....	2-81
<i>Unacceptable Locations for Logo Signs</i> .....	2-81
<i>Continuation of General Motorist Service Signs</i> .....	2-83
<i>Logo Requirements</i> .....	2-83
<i>Sign Panels</i> .....	2-85
<i>Application and Agreements</i> .....	2-88
<i>Funding and Responsibilities</i> .....	2-95
<i>Department Action</i> .....	2-96
<i>Changes in Program Administration</i> .....	2-96
2.15 CONGESTION MANAGEMENT SIGNS .....	2-104
<i>General</i> .....	2-104
<i>Park and Ride Signing</i> .....	2-104
<i>High Occupancy Vehicle Signs</i> .....	2-104
<i>Lane Restriction Signs</i> .....	2-105
<i>Ramp Metering Signs</i> .....	2-105
2.16 INCIDENT MANAGEMENT SIGNS.....	2-105
<i>General</i> .....	2-105
<i>Emergency Detour Signing</i> .....	2-106
<i>Crash Investigation Site Signing</i> .....	2-107
<i>Emergency Cellular Telephone Signs</i> .....	2-108

<i>Fire Hose Access Signs</i> .....	2-108
<i>Changeable Message Signs</i> .....	2-108
<i>Highway Advisory Radio Signs</i> .....	2-108
2.17    WELCOME CENTER AND REST AREA SIGNS.....	2-108
<i>General</i> .....	2-108
<i>Supplemental Signs</i> .....	2-108
2.18    PROCURING SIGNS AND SIGN ACCESSORIES.....	2-109
<i>County Sign Inventory</i> .....	2-109
<i>Materials from the Sign Shop</i> .....	2-109
2.19    CHAPTER 2 APPENDIX .....	2-115
<i>Proposed Traffic Route Change</i> .....	2-115
<i>Physical Limitations of the Proposed Traffic Route</i> .....	2-116
<i>Municipal Agreement re Traffic Route Change</i> .....	2-118
<i>Resolution Designating Signature Authority</i> .....	2-122
<b>CHAPTER 3 - MARKINGS.....</b>	<b>3-1</b>
3.1    GENERAL.....	3-1
<i>Purpose</i> .....	3-1
<i>Laws, Regulations and Other Publications</i> .....	3-1
<i>Definitions</i> .....	3-2
3.2    PAVEMENT MARKINGS .....	3-2
<i>Pavement Marking Materials</i> .....	3-3
<i>Black Contrast Markings</i> .....	3-6
<i>Minimum Retroreflectivity</i> .....	3-6
<i>Durable Pavement Markings</i> .....	3-7
<i>Pavement Markings in Construction and Resurfacing Projects</i> .....	3-7
<i>Raised Pavement Markers</i> .....	3-7
<i>Stop and Yield Lines</i> .....	3-9
<i>Crosswalks</i> .....	3-10
<i>Accessible Parking Spaces</i> .....	3-10
<i>Pavement Word and Symbol Markings</i> .....	3-12
<i>Speed Measurement Markings</i> .....	3-12
3.3    OBJECT MARKERS.....	3-13
<i>Object Marker Design</i> .....	3-13
3.4    DELINEATORS.....	3-14
<i>Delineation of Guiderail, Parapets and Barriers</i> .....	3-14
<i>Guiderail Delineation</i> .....	3-14
3.5    ISLANDS AND MEDIAN BARRIERS .....	3-15
<i>Mountable Curbs and Resurfacing</i> .....	3-15
3.6    CHAPTER 3 APPENDIX .....	3-16
<i>PAVEMENT MARKINGS - CONSTRUCTION INSPECTOR QUALITY ASSURANCE REVIEW FORM</i> .....	3-17
<b>CHAPTER 4 - TRAFFIC SIGNALS .....</b>	<b>4-1</b>
4.1    GENERAL.....	4-1
<i>Purpose</i> .....	4-1
<i>Types of Traffic Signals</i> .....	4-1
<i>Responsibility to Approve, Install, and Maintain Traffic Signals</i> .....	4-1
<i>Laws, Regulations, and Other Publications</i> .....	4-2
<i>Meaning and Application of the Traffic Signal Indications Vehicular Signal Indications</i> .....	4-5
<i>Pedestrian Indications</i> .....	4-9
<i>Alternatives to Traffic Signals</i> .....	4-10
<i>PennDOT's Traffic Signal Portal</i> .....	4-11

4.2	REQUESTS FOR TRAFFIC SIGNALS .....	4-11
	<i>Application and Financial Commitment</i> .....	4-11
	<i>Procedure</i> .....	4-11
	<i>Application by Local Authorities</i> .....	4-13
	<i>Transfer of Authority to Local Authorities</i> .....	4-13
4.3	TRAFFIC SIGNAL WARRANTS AND ENGINEERING STUDIES .....	4-17
	<i>General</i> .....	4-17
	<i>Traffic Control Signal Warrants</i> .....	4-17
	<i>Intersection Control Beacon Warrants</i> .....	4-22
	<i>Flashing Beacons Guidance</i> .....	4-23
	<i>Advanced Warning Beacons/Flashers and Internally Illuminated Advanced Warning Signs</i> .....	4-23
	<i>Ramp Metering Guidance</i> .....	4-31
	<i>In-Roadway Warning Lights</i> .....	4-31
	<i>Rectangular Rapid Flashing Beacon Guidance</i> .....	4-32
	<i>Pedestrian Study</i> .....	4-33
	<i>Analysis of Data and Traffic Engineering Study</i> .....	4-33
	<i>Department Participation</i> .....	4-35
	<i>Vehicle Change and Clearance Intervals</i> .....	4-36
	<i>Pedestrian Intervals</i> .....	4-39
	<i>Capacity Analysis</i> .....	4-41
4.4	PERMITS .....	4-44
	<i>General</i> .....	4-44
	<i>Authority for Issuing</i> .....	4-44
4.5	TRAFFIC SIGNAL SPACING .....	4-46
4.6	DESIGN .....	4-48
	<i>General</i> .....	4-48
	<i>Traffic Signals near Grade Crossings</i> .....	4-50
	<i>Traffic Signal Plans</i> .....	4-52
	<i>Preemption and Priority Control Detection Systems</i> .....	4-60
	<i>Positive Offset for Opposing Left-Turn Lanes</i> .....	4-65
	<i>Left-Turn Signal Phasing</i> .....	4-65
	<i>White Strobe Lights within or adjacent to Red Traffic Signal Indications</i> .....	4-66
	<i>Overhead Street Name Signs</i> .....	4-67
	<i>Advance Street Name Signs</i> .....	4-68
	<i>Lane Control Signs</i> .....	4-68
	<i>Internally Illuminated Street Name Signs</i> .....	4-69
4.7	EQUIPMENT .....	4-69
	<i>General</i> .....	4-70
	<i>Use of Auxiliary Equipment</i> .....	4-70
	<i>Traffic Signal Structural Support Approval</i> .....	4-70
	<i>Request for Proprietary Specifications</i> .....	4-72
	<i>Requests for Change of Signal Equipment</i> .....	4-73
	<i>Light Emitting Diodes (LEDs)</i> .....	4-73
	<i>Certificates of Approval</i> .....	4-74
4.8	OPERATION .....	4-75
	<i>General</i> .....	4-75
	<i>Types of Operation</i> .....	4-75
4.9	CONSTRUCTION .....	4-76
	<i>General</i> .....	4-76
	<i>Operational Testing and Guarantee</i> .....	4-76
	<i>Acceptance of Traffic Signal Materials</i> .....	4-77
	<i>Final Acceptance of a Traffic Signal</i> .....	4-78



<i>Guidelines for Traffic Signal Construction Inspection</i> .....	4-78
4.10 MAINTENANCE.....	4-83
<i>General</i> .....	4-83
<i>Annual Program</i> .....	4-84
<i>Project Reviews</i> .....	4-84
<i>Maintenance Evaluation Procedures</i> .....	4-85
<i>Quality Assurance Review Form</i> .....	4-87
4.11 REMOVAL OF TRAFFIC SIGNALS.....	4-88
<i>General</i> .....	4-88
4.12 ADAPTIVE TRAFFIC CONTROL SYSTEMS.....	4-89
4.13 AUTOMATED RED LIGHT ENFORCEMENT.....	4-89
4.14 TRAFFIC SIGNAL ASSET MANAGEMENT SYSTEM (TSAMS).....	4-89
4.15 APPROVED 67 PA. CODE CHAPTER 205 MUNICIPALITIES.....	4-90
<b>CHAPTER 5 - LOW-VOLUME ROADS.....</b>	<b>5-1</b>
5.1 GENERAL.....	5-1
<i>Purpose</i> .....	5-1
<i>Laws, Regulations and Other Publications</i> .....	5-1
<b>CHAPTER 6 - TEMPORARY TRAFFIC CONTROL.....</b>	<b>6-1</b>
6.1 GENERAL.....	6-1
<i>General</i> .....	6-1
<i>Laws, Regulations, and Publications</i> .....	6-1
<i>Definitions</i> .....	6-1
6.2 SAFETY.....	6-3
<i>Safety First</i> .....	6-3
<i>Pennsylvania State Police (PSP) Cooperation</i> .....	6-3
<i>Work on Limited Access Highways</i> .....	6-3
6.3 WORK ZONE SAFETY AND MOBILITY.....	6-4
<i>Work Zone Safety and Mobility Policy (WZSM)</i> .....	6-4
<i>WZSM Implementation</i> .....	6-5
<i>WZSM Transportation Management Plan (TMP)</i> .....	6-12
<i>Sample Transportation Management Plan (TMP)</i> .....	6-14
<i>WZSM Transportation Operations Plan (TOP)</i> .....	6-15
<i>WZSM Public Information Plan (PIP)</i> .....	6-17
<i>WZSM Definitions</i> .....	6-18
6.4 DISTRICT RESPONSIBILITIES.....	6-18
<i>District Traffic Unit</i> .....	6-18
<i>District Construction Unit</i> .....	6-20
6.5 QUALITY ASSURANCE.....	6-21
<i>Independent Oversight Program (IOP) with FHWA</i> .....	6-21
<i>Other Quality Assurance Reviews</i> .....	6-21
<i>Quality Assurance Review Form</i> .....	6-21
6.6 TRAFFIC SIGNS.....	6-22
<i>General</i> .....	6-22
<i>Act 229 Signs</i> .....	6-23
<i>Temporary Business Signs in Work Zones</i> .....	6-23
<i>Winter Shutdown</i> .....	6-24
<i>Portable Dynamic Message Signs</i> .....	6-24
<i>Advance Notice of Pending Work</i> .....	6-25
6.7 PAVEMENT MARKINGS AND DELINEATION.....	6-25

<i>General</i> .....	6-25
<i>Compliance by Engineering Districts</i> .....	6-25
<i>Pavement Markings in Work Zones</i> .....	6-26
<i>Delineation of Temporary Concrete Median Barriers</i> .....	6-26
<i>Temporary Shadow Lines</i> .....	6-26
6.8 TRAFFIC SIGNALS .....	6-27
<i>Traffic Control Signals</i> .....	6-27
6.9 BARRIERS, DRUMS AND FENCES .....	6-27
<i>Temporary Concrete Barrier Types</i> .....	6-27
<i>Drums</i> .....	6-28
<i>Reflective Plastic Safety Fence</i> .....	6-28
<i>Non-Conforming Traffic Control Devices</i> .....	6-28
<i>Certification of Compliance – Materials and Products</i> .....	6-28
6.10 ARROW PANELS AND WARNING LIGHTS .....	6-28
<i>Arrow Panels</i> .....	6-28
<i>Warning Lights</i> .....	6-29
6.11 SHADOW VEHICLES AND IMPACT ATTENUATORS .....	6-30
<i>Shadow Vehicle(s) Required</i> .....	6-30
<i>Occupancy of Shadow Vehicles</i> .....	6-30
<i>Size, Weight, and Equipment for Shadow Vehicles</i> .....	6-31
<i>Impact Attenuator System Design</i> .....	6-31
6.12 WORKERS’ ATTIRE .....	6-32
<i>Required Attire</i> .....	6-32
<i>Ordering High Visibility Garments</i> .....	6-32
<i>Reflective Tape on Hard Hats</i> .....	6-33
6.13 SPECIALIZED OPERATIONS .....	6-33
<i>Counter Installation</i> .....	6-33
<i>Backing Up or Driving in a Counter-Flow Direction</i> .....	6-35
<i>Mobile and Stationary Maintenance Operations</i> .....	6-35
<i>Mowing Operations</i> .....	6-35
<i>Department Surveying Operations</i> .....	6-36
6.14 TRAFFIC CONTROL PLAN (TCP) DESIGN CONSIDERATIONS.....	6-36
<i>General</i> .....	6-36
<i>Work Zone Safety Design Considerations</i> .....	6-36
<i>Work Zone Congestion Reduction</i> .....	6-44
<i>Detours</i> .....	6-49
<i>Overwidth Vehicles</i> .....	6-53
6.15 STATE POLICE ASSISTANCE .....	6-54
<i>Memorandum of Understanding (MOU)</i> .....	6-54
<i>Budget</i> .....	6-54
<i>Administrative Procedures</i> .....	6-55
<i>Coordination</i> .....	6-56
<i>SAP Procedures</i> .....	6-57
<i>Police Assistance in Adjacent States</i> .....	6-57
<i>Additional Guidelines for Maintenance Projects</i> .....	6-58
6.16 CHAPTER 6 APPENDIX .....	6-60
<i>Sample Transportation Management Plan</i> .....	6-61
<i>Act 229 Requirements in Chapter 212</i> .....	6-72
<i>Sand Barrel Layouts</i> .....	6-74
<i>Guidelines for Required Police Arrest Form</i> .....	6-76
<i>Example Detour Letter</i> .....	6-77
<i>Example Detour Agreement</i> .....	6-78

---

<b>CHAPTER 7 - SCHOOL AREAS .....</b>	<b>7-1</b>
7.1 GENERAL.....	7-1
<i>Need for Standards.....</i>	7-1
<i>Laws, Regulations and Other Publications.....</i>	7-1
<i>Definitions.....</i>	7-1
7.2 SCHOOL ZONE SPEED LIMITS .....	7-2
<i>Criteria .....</i>	7-2
<i>Signing Requirements.....</i>	7-2
7.3 STUDENT-WALKING ROUTES .....	7-2
<i>Legislative Requirement .....</i>	7-2
<i>Department Regulations and Interpretations.....</i>	7-2
<i>Field Study and Evaluation .....</i>	7-3
<i>Certification.....</i>	7-4
7.4 CHAPTER 7 APPENDIX .....	7-6
<i>67 Pa. Code §212.501 - School Zone Speed Limits .....</i>	7-7
<i>67 Pa. Code Chapter 447 - Hazardous Walking Routes .....</i>	7-9
<i>Student-Walking Route - Study and Data Sheet .....</i>	7-14
<i>Student Walking Route Certification .....</i>	7-20
<b>CHAPTER 8 - HIGHWAY-RAIL GRADE CROSSINGS.....</b>	<b>8-1</b>
8.1 GENERAL.....	8-1
<i>Purpose .....</i>	8-1
<i>Laws, Regulations and Other Publications.....</i>	8-1
<i>Definitions.....</i>	8-1
8.2 MISCELLANEOUS PROVISIONS .....	8-2
<i>Abandoned Railroad Grade Crossings.....</i>	8-2
<i>Placement of the Advance Warning Sign.....</i>	8-2
<i>Pavement Markings.....</i>	8-3
<i>Maintenance Responsibilities.....</i>	8-3
<i>Retroreflective Strips on Crossbuck Signs and Supports.....</i>	8-3
<b>CHAPTER 9 - BICYCLE FACILITIES.....</b>	<b>9-1</b>
9.1 GENERAL.....	9-1
<i>Purpose .....</i>	9-1
<i>Integration of Bicycle Travel into the Planning and Design Process .....</i>	9-1
<i>Laws, Regulations and Other Publications.....</i>	9-1
<i>Definitions.....</i>	9-1
9.2 BICYCLE ROUTES.....	9-2
<i>BicyclePA Routes.....</i>	9-2
9.3 MISCELLANEOUS PROVISIONS .....	9-2
<i>Bicycles on Freeways .....</i>	9-2
<i>Longitudinal Rumble Strips.....</i>	9-4
9.4 CHAPTER 9 APPENDIX .....	9-5
<i>Request to Operate a Pedalcycle on a Freeway.....</i>	9-6
<b>CHAPTER 10 - HIGHWAY CAPACITY MANUAL AND DATA COLLECTION PARAMETERS.....</b>	<b>10-1</b>
10.1 GENERAL.....	10-1
<i>Purpose .....</i>	10-1
<i>Engineering Judgment.....</i>	10-1
10.2 TRAFFIC STUDY PARAMETERS .....	10-2
<i>Overview.....</i>	10-2

<i>Traffic Volumes</i> .....	10-2
<i>Intersection Delay Studies</i> .....	10-5
<i>Queue Length Studies</i> .....	10-6
<i>Saturation Flow Rate Studies</i> .....	10-6
<i>Gap Acceptance Studies</i> .....	10-8
<i>Projected Volume Analysis</i> .....	10-10
<i>Traffic Signal Warrant Analysis</i> .....	10-10
<i>Turn Lane Warrant Analysis</i> .....	10-10
<i>Left-Turn Phase Warrant Analysis</i> .....	10-10
10.3 TRAFFIC ANALYSIS TOOL SELECTION.....	10-11
<i>Project Understanding and Analysis Context</i> .....	10-11
<i>Overview</i> .....	10-11
<i>FHWA Decision Support Methodology (DSM)</i> .....	10-13
<i>Tool Selection Matrix</i> .....	10-14
10.4 HIGHWAY CAPACITY MANUAL (HCM) ANALYSIS .....	10-17
<i>Role</i> .....	10-17
<i>Online Material</i> .....	10-17
<i>Pennsylvania Default Values</i> .....	10-17
<i>Multi-Period Analysis</i> .....	10-21
<i>Demand versus Service</i> .....	10-22
<i>Peak Hour Factors</i> .....	10-22
<i>Signalized Intersections</i> .....	10-22
<i>Two-Way Stop-Controlled (TWSC) Intersections</i> .....	10-23
<i>All-Way Stop-Controlled (AWSC) Intersections</i> .....	10-23
<i>Mid-Block Pedestrian Crossings</i> .....	10-23
<i>Roundabouts</i> .....	10-24
<i>Urban Streets</i> .....	10-24
<i>Freeway Facilities</i> .....	10-25
10.5 MULTIMODAL ANALYSIS .....	10-26
<i>Overview</i> .....	10-26
<i>Smart Transportation Context</i> .....	10-26
<i>Pedestrian Mode</i> .....	10-26
<i>Pedestrian Walking Speed</i> .....	10-26
<i>Bicycle Mode</i> .....	10-26
<i>Transit Mode</i> .....	10-27
10.6 ALTERNATIVE TOOL ANALYSIS .....	10-28
<i>Guidance</i> .....	10-28
<i>Highway Capacity Manual Limitations</i> .....	10-28
<i>Application</i> .....	10-28
10.7 VERIFICATION, CALIBRATION, AND VALIDATION .....	10-29
<i>Verification</i> .....	10-29
<i>Calibration</i> .....	10-29
<i>Validation</i> .....	10-30
10.8 TRAFFIC ANALYSIS CHECKLIST .....	10-31
<i>Overview</i> .....	10-31
<i>Process</i> .....	10-31
<b>11. TRAFFIC STUDIES.....</b>	<b>1</b>
11.1 GENERAL.....	1
<i>Engineering Study and Engineering Judgment</i> .....	1
<i>Definitions</i> .....	2
<i>Customer Service</i> .....	5

<i>Traffic Impact Studies – Seal by a Professional Engineer</i> .....	7
<i>Performing Engineering and Traffic Studies on Local Roads</i> .....	7
<i>Release of Studies to the General Public</i> .....	8
<i>Laws, Regulations, Forms and Other Publications</i> .....	9
11.2    APPROVALS.....	10
<i>References</i> .....	10
<i>Department Approval on State Highways</i> .....	10
11.3    SPEED RESTRICTIONS.....	11
<i>References</i> .....	11
<i>Crash Rates</i> .....	11
<i>Electronic Ball Bank Instruments</i> .....	12
<i>25-mph Speed Limit in “Residence Districts”</i> .....	12
<i>65-mph Speed Limits</i> .....	14
<i>Legal Challenges</i> .....	15
11.4    NO-PASSING ZONES.....	16
<i>Warrants</i> .....	16
<i>Establishment of No-Passing Zones through Intersections</i> .....	17
11.5    ONE-LANE AND NARROW BRIDGES AND UNDERPASSES.....	17
<i>General</i> .....	17
<i>Suggested Traffic Control</i> .....	17
<i>Optional Traffic Control</i> .....	18
11.6    ANGLE PARKING.....	18
<i>General Criteria</i> .....	18
<i>Reevaluation of Existing Angle Parking</i> .....	19
<i>Back-In Angle Parking</i> .....	19
11.7    WEIGHT AND SIZE RESTRICTIONS.....	20
<i>References</i> .....	20
<i>Restrictions Based on Condition of Highway or Bridge</i> .....	21
<i>Restrictions Based on Traffic Conditions</i> .....	21
<i>Exceptions and Permits</i> .....	22
<i>Oversize and Overweight Vehicle Traffic Control Plans (TCPs)</i> .....	23
<i>Bridge Crawl Speeds</i> .....	23
11.8    ENGINE BRAKE RETARDER PROHIBITION POLICY.....	24
<i>Prohibition Request Procedure</i> .....	24
<i>Criteria for Prohibition Approval</i> .....	24
11.9    UNSIGNALIZED MIDBLOCK CROSSWALKS.....	25
<i>Background</i> .....	25
<i>Minimum Requirements for New Midblock Installations</i> .....	25
<i>Design Considerations</i> .....	26
11.10   MIRRORS.....	27
<i>General</i> .....	27
<i>Minimum Warrants</i> .....	27
<i>Installation Guidelines</i> .....	28
11.11   HIGHWAY OCCUPANCY.....	28
<i>References</i> .....	28
<i>District Traffic Engineering Unit Responsibilities</i> .....	28
<i>Additional Review Guidelines</i> .....	29
11.12   MUNICIPAL WASTE FACILITIES.....	30
<i>General</i> .....	30
<i>References</i> .....	30
<i>District Involvement with DEP Reviews</i> .....	30

	<i>Transportation Impact Study (TIS) Guidelines</i> .....	32
11.13	SNOWMOBILE AND ALL-TERRAIN VEHICLE ROADS.....	42
	<i>References</i> .....	42
	<i>Establishing Snowmobile and/or ATV Roads on State Highways</i> .....	43
11.14	CLOSING STATE HIGHWAYS FOR SPECIAL EVENTS .....	43
	<i>References</i> .....	43
	<i>Policy</i> .....	44
11.15	TURNBACK OF TRAFFIC RESTRICTIONS .....	44
	<i>General</i> .....	44
	<i>Suggested Transmittal Letter</i> .....	44
11.16	TURN LANE GUIDELINES .....	45
	<i>General</i> .....	45
	<i>Traffic Engineering Software</i> .....	45
	<i>Truck Adjustment Factors</i> .....	45
	<i>Turn Lane Warrants</i> .....	46
	<i>Turn Lane Storage Length</i> .....	46
	<i>Other Warranting Factors and Considerations</i> .....	48
	<i>Example Problem</i> .....	48
	<i>References</i> .....	50
11.17	CHAPTER 11 APPENDIX .....	52
	<i>Study Elements that Suggest a Speed Limit Below 65 mph</i> .....	53
	<i>Traffic Control Plan for Superloads and Non-Superloads on Freeways with Bridge Crawl Speeds</i> .....	54
	<i>Traffic Control Plan for Superloads and Non-Superloads on Two-Lane, Two-Way Roadways with Bridge Crawl Speeds</i> .....	56
	<i>Resolution Requesting the Designation of a Snowmobile Road</i> .....	58
	<i>Turn Lane Warrant Figures</i> .....	60
<b>12.</b>	<b>TRAFFIC ENGINEERING SOFTWARE</b> .....	<b>1</b>
12.1	GENERAL.....	1
	<i>Purpose</i> .....	1
	<i>Traffic Resources, Education, and Computing Support (TRECS) Group</i> .....	1
12.2	SPECIFIC SOFTWARE.....	1
	<i>Supported Software</i> .....	1
	<i>Traffic Analysis Tool Selection Process</i> .....	2
	<i>Required Use by Department and Consultants</i> .....	2
<b>13</b>	<b>INTELLIGENT TRANSPORTATION SYSTEMS (ITS)</b> .....	<b>1</b>

**TABLE OF EXHIBITS**

EXHIBIT 1-1 ACCEPTABLE ABBREVIATIONS FOR TRAFFIC CONTROL DEVICES ..... 1-8

EXHIBIT 1-2 FORM LETTER TO MUNICIPALITIES ..... 1-18

EXHIBIT 1-3 CENTRAL OFFICE FORM FOR ACCESS ROUTE REQUESTS ..... 1-20

EXHIBIT 1-4 DISTRICT FORM FOR ACCESS ROUTE REQUESTS ..... 1-21

EXHIBIT 1-5 ACCESS ROUTE APPROVAL FORMS ..... 1-22

EXHIBIT 2-1 TYPES OF RETROREFLECTION ..... 2-2

EXHIBIT 2-2 GRAPHIC ILLUSTRATION OF THE OBSERVATION ANGLE ..... 2-3

EXHIBIT 2-3 RETROREFLECTIVE MATERIALS FOR PERMANENT SIGNS ..... 2-4

EXHIBIT 2-4 MINIMUM MAINTAINED RETROREFLECTIVITY LEVELS ..... 2-5

EXHIBIT 2-5 “FIELD” APPLICATION OF PRESSURE-SENSITIVE LEGEND ..... 2-15

EXHIBIT 2-6 GUIDELINES FOR ADVANCE PLACEMENT OF WARNING SIGNS ..... 2-17

EXHIBIT 2-7 MAXIMUM BALL-BANK INDICATOR READINGS ..... 2-18

EXHIBIT 2-8 SUGGESTED SPACING FOR W1-8 SIGNS ..... 2-20

EXHIBIT 2-9 ESTIMATING THE DEGREE OF CURVE ..... 2-21

EXHIBIT 2-10 ORDER OF DESTINATIONS FOR DOUBLE SIDE ROAD SIGN ..... 2-23

EXHIBIT 2-11 TRANSITIONING TO THE CLEARVIEW FONT ..... 2-26

EXHIBIT 2-12 INTER-LETTER SPACING OF CLEARVIEW FONT ..... 2-27

EXHIBIT 2-13 LONGITUDINAL PLACEMENT ..... 2-33

EXHIBIT 2-14 TODS (D7-4) ..... 2-48

EXHIBIT 2-15 ACCEPTABLE SYMBOLS ..... 2-49

EXHIBIT 2-16 APPLICATION FOR SIGNING DISTRICT ..... 2-50

EXHIBIT 2-17 SAMPLE MEMORIAL HIGHWAY SIGN DESIGN ..... 2-58

EXHIBIT 2-18 SR AND SEGMENT MARKERS TABULATION SHEET ..... 2-64

EXHIBIT 2-19 NATIONAL CONTROL CITIES IN OR ADJACENT TO PENNSYLVANIA ..... 2-67

EXHIBIT 2-20 VERSIONS OF REFERENCE LOCATION SIGNS ..... 2-69

EXHIBIT 2-21 MOTORIST SERVICE SYMBOLS ..... 2-73

EXHIBIT 2-22 APPLICATION FOR GENERAL MOTORIST SIGNS ..... 2-76

EXHIBIT 2-23 ELIGIBLE ATTRACTIONS FOR LOGOS ..... 2-79

EXHIBIT 2-24 TYPICAL SIGNING FOR SINGLE-EXIT INTERCHANGES ..... 2-97

EXHIBIT 2-25 TYPICAL SPECIFIC SERVICE SIGNS ..... 2-98

EXHIBIT 2-26 TYPICAL THREE-SERVICE SIGN ..... 2-99

EXHIBIT 2-27 TYPICAL LOGOS ..... 2-100

EXHIBIT 2-28 RAMP SIGNS AND TRAILBLAZERS ..... 2-101

EXHIBIT 2-29 RAMP SIGN INSTALLATION (4- AND 6-PANEL LOGOS) ..... 2-102

EXHIBIT 2-30 ATTRACTION TRAILBLAZER ..... 2-103

EXHIBIT 2-31 RV ACCESS SYMBOL ..... 2-104

EXHIBIT 2-32 SUGGESTED COUNTY SIGN SAFETY STOCK ..... 2-112

EXHIBIT 2-33 ORDERING CUSTOM SIGNS ..... 2-114

EXHIBIT 3-1 PAVEMENT MARKING MATERIALS ..... 3-3

EXHIBIT 3-2 MATERIAL COMPATIBILITY FOR RESTRIPIING ..... 3-6

EXHIBIT 3-3 DOTTED WHITE EDGE LINES ..... 3-10

EXHIBIT 3-4 MINIMUM ACCESSIBLE PARKING SPACES ..... 3-11

EXHIBIT 3-5 TYPICAL ADA ACCESSIBLE PARKING SPACE LAYOUTS ..... 3-11

EXHIBIT 3-6 PARKING SPACE MARKING WITH BLUE BACKGROUND ..... 3-12

EXHIBIT 3-7 OBJECT AND END-OF-ROADWAY MARKERS ..... 3-14

EXHIBIT 4-1 RESPONSIBILITIES OF LOCAL AUTHORITIES AND THE DEPARTMENT ..... 4-3

EXHIBIT 4-2 APPLICABLE LAWS, REGULATIONS, AND PUBLICATIONS ..... 4-4

EXHIBIT 4-3 OTHER DEPARTMENT AND PUBLIC AGENCY DOCUMENTS ..... 4-5

EXHIBIT 4-4 TYPICAL PEDESTRIAN INDICATIONS ..... 4-9

EXHIBIT 4-5 TOA AGREEMENT EXPANDS THE MTEC AUTHORIZATION ..... 4-14

EXHIBIT 4-6	GUIDELINES FOR OPTIONAL TRAFFIC SIGNAL WARRANT FOR MIDBLOCK CROSSING AND TRAIL CROSSINGS (LOW-SPEED ROADWAYS) .....	4-21
EXHIBIT 4-7	GUIDELINES FOR OPTIONAL TRAFFIC SIGNAL WARRANT FOR MIDBLOCK CROSSING AND TRAIL CROSSINGS (HIGH-SPEED ROADWAYS) .....	4-22
EXHIBIT 4-8	INTERSECTION FLASHING BEACON LIMITED VISIBILITY WARRANT .....	4-23
EXHIBIT 4-9	ADVANCED WARNING FLASHER AND INTERNALLY ILLUMINATED WARNING SIGN.....	4-24
EXHIBIT 4-10	AWF AND IIWS CRITERIA GUIDELINES .....	4-24
EXHIBIT 4-11	AWF OR IIWS LIMITED SIGHT DISTANCE (> 15% TRUCKS).....	4-27
EXHIBIT 4-12	AWF OR IIWS LIMITED SIGHT DISTANCE (≤ 15% TRUCKS).....	4-28
EXHIBIT 4-13	AWF OR IIWS RECOMMENDED YELLOW INTERVALS (> 15% TRUCKS) .....	4-29
EXHIBIT 4-14	AWF OR IIWS RECOMMENDED YELLOW INTERVALS (≤ 15% TRUCKS) .....	4-30
EXHIBIT 4-15	SCHOOL SPEED LIMIT SIGN SYSTEM.....	4-31
EXHIBIT 4-16	CURVE AHEAD WARNING SYSTEM .....	4-31
EXHIBIT 4-17	IN-ROADWAY WARNING LIGHTS .....	4-32
EXHIBIT 4-18	RECTANGULAR RAPID FLASHING BEACON.....	4-32
EXHIBIT 4-19	YELLOW CHANGE INTERVAL .....	4-37
EXHIBIT 4-20	DEFINITION OF TERMS FOR ALL-RED CLEARANCE INTERVALS.....	4-38
EXHIBIT 4-21	ALL-RED CLEARANCE INTERVAL .....	4-39
EXHIBIT 4-22	NO TURN ON RED MINIMUM SITE DISTANCE.....	4-42
EXHIBIT 4-23	TRAFFIC SIGNAL SPACING .....	4-46
EXHIBIT 4-24	MINIMUM VISIBILITY DISTANCE IN ADVANCE OF STOP LINE .....	4-49
EXHIBIT 4-25	REQUIRED PUC INVOLVEMENT .....	4-50
EXHIBIT 4-26	TRAFFIC SIGNAL PHASE NUMBERS .....	4-56
EXHIBIT 4-27	NEMA DUAL RING STRUCTURE .....	4-57
EXHIBIT 4-28	PORTABLE TRAFFIC CONTROL SIGNALS.....	4-63
EXHIBIT 4-29	REFERENCE GUIDE FOR PATA 26E.....	4-64
EXHIBIT 4-30	POSITIVE OFFSET FOR LEFT-TURN LANES.....	4-65
EXHIBIT 4-31	TRAFFIC SIGNAL WHITE STROBE LIGHTS.....	4-67
EXHIBIT 4-32	OVERHEAD STREET NAME SIGNS .....	4-67
EXHIBIT 4-33	ADVANCE STREET NAME SIGN .....	4-68
EXHIBIT 4-34	LANE CONTROL SIGNS .....	4-69
EXHIBIT 4-35	INTERNALLY ILLUMINATED STREET NAME SIGN.....	4-69
EXHIBIT 6-1	DETERMINATION OF SIGNIFICANT PROJECTS - FLOW CHART .....	6-7
EXHIBIT 6-2	DETERMINATION OF SIGNIFICANT PROJECTS - FLOW CHART STEP DESCRIPTIONS .....	6-8
EXHIBIT 6-3	DETERMINATION OF SIGNIFICANT PROJECT – SUBMISSION APPROVAL PROCESS .....	6-9
EXHIBIT 6-4	WZSM IN PROJECT DEVELOPMENT PROCESS - KEY ITEMS .....	6-10
EXHIBIT 6-5	TMP ELEMENTS.....	6-13
EXHIBIT 6-6	USE OF TYPE C LIGHTS THROUGH WORK ZONE.....	6-30
EXHIBIT 6-7	ALTERNATE LANE CLOSURE NEAR AN EXIT RAMP .....	6-40
EXHIBIT 6-8	EMERGENCY PULL-OFF .....	6-41
EXHIBIT 6-9	TEMPORARY BITUMINOUS RUMBLE STRIPS.....	6-42
EXHIBIT 6-10	COSTS TO ENHANCE WORK ZONE SAFETY .....	6-43
EXHIBIT 6-11	LATE MERGE.....	6-47
EXHIBIT 6-12	DETOURS ON LOCAL ROADS.....	6-50
EXHIBIT 6-13	DETOURING TRAFFIC VS. CLOSING THE ROAD.....	6-51
EXHIBIT 7-1	PAYMENTS ON ACCOUNT OF PUPIL TRANSPORTATION (24 P.S. §25-2541(c)) .....	7-5
EXHIBIT 11-1	CHAPTER STUDIES AND CROSS REFERENCES .....	1
EXHIBIT 11-2	ADVANCE DISTANCE FOR NO-PASSING ZONES .....	16
EXHIBIT 11-3	DIAGONAL PARKING MINIMUM MANEUVER AREA .....	18
EXHIBIT 11-4	BACK-IN ANGLE PARKING.....	20
EXHIBIT 11-5	TRUCK ADJUSTMENT FACTORS .....	45
EXHIBIT 11-6	TURN LANE STORAGE - TYPE OF TRAFFIC CONTROL CONDITION (A, B OR C).....	46
EXHIBIT 11-7	TURN LANE STORAGE – FOR SPEED AND CONDITION.....	47



---

EXHIBIT 11-8	TURN LANE STORAGE BASED ON AVERAGE NO. OF VEHICLES/CYCLE.....	47
EXHIBIT 11-9	SAMPLE LETTER RE THE TURNBACK OF TRAFFIC RESTRICTIONS.....	51

## CHAPTER 1 - GENERAL

### 1.1 Overview

#### Purpose

The purpose of traffic control devices on streets and highways is to promote highway safety and efficiency by providing for the orderly movement of all road users. Traffic control devices notify users of regulations, and provide warning and guidance needed for the reasonably safe and efficient operation of all elements of the traffic stream.

Traffic control devices and their supports should not bear any advertising messages that are not related to traffic control. It is important to recognize, however, that Tourist-Oriented Directional Signs (TODS) and Specific Services Signs are not classified as advertising, but rather motorist service signing.

Although some highway design features, such as curbs, median barriers, guiderails, speed humps or tables, and textured pavement, have a significant impact on traffic operations and safety, they are not considered to be traffic control devices and provisions regarding their design and use are generally not included in this Manual.

#### State and Federal Mandates

The Department adopted the Federal Highway Administration's (FHWA's) *Manual on Uniform Traffic Control Devices (MUTCD)* by reference when it adopted §212.2 ([67 Pa. Code §212.2](#)) on February 3, 2006 at [36 Pa.B. 537](#).

The *MUTCD* is the national standard for all traffic control traffic devices installed on any street or highway in the United States. FHWA and the National Committee on Uniform Traffic Control Devices (NCUTCD) jointly develop the *MUTCD*, and the U.S. Secretary of Transportation ultimately approves it.

Throughout the *MUTCD*, it uses the words "standard," "guidance," "option," and "support" to provide the information required to make appropriate decisions regarding the use of traffic control devices on streets and highways.

The *MUTCD* defines these terms as follows:

1. "Standard"—a statement of required, mandatory, or specifically prohibitive practice regarding a traffic control device. All Standard statements are labeled, and the text appears in bold type. The verb "shall" is typically used. The verbs "should" and "may" are not used in Standard statements. Standard statements are sometimes modified by Options. Standard statements shall not be modified or compromised based on engineering judgment or engineering study.
2. "Guidance" – a statement of recommended, but not a mandatory, practice in typical situations. Deviations are allowable if, engineering judgment or engineering study indicates the deviation to be appropriate. The verb "should" is typically used.
3. "Option" – a statement of practice that carries no requirement or recommendation. The verb "may" is typically used.
4. "Support" – an informational statement that carries no degree of mandate, recommendation, authorization, prohibition or an enforceable condition. Support statements use the verbs "shall," "should," and "may."

The *MUTCD* and this manual both reference many other publications. The section **Laws, Regulations, Forms and Other Publications** on [page 1-5](#) identifies both these national publications, and many PennDOT manuals, standards and specifications.

This manual supplements the *MUTCD* and the other referenced manuals, and is designed for the use of PennDOT employees and those working for PennDOT, who are responsible to design, place and maintain signs on all State highways.

### **Principles of Traffic Control Devices**

As noted in Section 1A.02 of the *MUTCD*, to be effective, a traffic control device should meet five basic requirements:

- A. Fulfill a need;
- B. Command attention;
- C. Convey a clear, simple meaning;
- D. Command respect from road users; and
- E. Give adequate time for proper response.

Therefore, it is important to consider the design, placement, operation, maintenance, and uniformity of all traffic control devices in order to maximize their ability to meet these five requirements. Also, carefully consider vehicle speed as an element that governs the design, operation, placement, and location of virtually all traffic control devices.

The proper use of traffic control devices should provide the reasonable and prudent road user with the information necessary to use the streets, highways, pedestrian facilities, and bikeways, both safely and lawfully. Uniformity of the meaning and application of traffic control devices is vital to their effectiveness.

### **Engineering Study and Engineering Judgment**

Always base the decision to use a particular device at a specific location on an engineering study and the application of engineering judgment. Thus, while this manual provides guidance and some engineering studies, it is not a substitute for engineering judgment.

Exercise engineering judgment in the selection and application of traffic control devices, as well as in the location and design of the roads and streets that the devices complement. Therefore, a professional engineer or similarly qualified engineer should make the final decision concerning the application of traffic restrictions.

### **Requests to Experiment with Unique Traffic Control Devices**

If personnel from an Engineering District, the Central Office or local government wish to experiment with a traffic control device, or request an official change to or an interpretation of the requirements of the *MUTCD* or 67 Pa. Code 212, they should submit a request in writing to the Traffic Engineering and Operations Division, Bureau of Maintenance and Operations, defining the proposal.

The request must include information in accordance with Section 1A.10 of the *MUTCD* (relating to interpretations, experimentation, changes and interim approvals), and identify the information that will be compiled during any experiment identified in the request. If deemed appropriate, the Traffic Engineering and Operations Division will prepare a request to the FHWA.

If a request to experiment is approved, the Department will typically be obligated to collect data and develop a follow-up report for FHWA.

Except as provided in Paragraph 4, Section 1A.10 of the Federal MUTCD, requests for any interpretation, permission to experiment, interim approval, or change shall be submitted electronically to the Federal Highway Administration (FHWA), Office of Transportation Operations, MUTCD team, at the following e-mail address: [MUTCDofficialrequest@dot.gov](mailto:MUTCDofficialrequest@dot.gov). If electronic submittal is not possible, requests for interpretations, permission to experiment, interim approvals, or changes may instead be mailed to the Office of Transportation Operations, HOTO-1, Federal Highway Administration, 1200 New Jersey Avenue, SE, Washington, DC 20590.

## Older Drivers

Another increasingly important consideration is our aging population. As people age, vision declines, physical fitness and flexibility diminish, the ability to focus attention decreases, and the time to react to unexpected circumstances increases. Each of these changes affects one's ability to safely drive or use a crosswalk. For our older population to maintain their mobility without compromising safety, as transportation professionals we must consider their needs when applying traffic control devices.

Some specific difficulties that older drivers experience include:

1. Declining eyesight affects their ability to see signs, pavement markings, pedestrians, and other vehicles.
2. Difficulty reading signs and pavement markings at night due to glare from on-coming headlights, especially when the roads are wet.
3. Decreased physical fitness and their inability to turn their heads, which may make seeing some signs more difficult.
4. Slower response to unexpected conditions.
5. Incorrectly interpreting some signs and pavement markings.
6. Difficulty making left turns due to improper positioning in the turn lane and the inability to judge the distance of oncoming vehicles.
7. Slower gait, shorter steps, and slower reaction time requiring longer time for pedestrian crossing.

The Department desires to assist the older population whenever possible, which in turn generally assists everyone. FHWA's *Highway Design Handbook for Older Drivers and Pedestrians* is a good resource for helping the older driver.

Therefore, consider incorporating the following enhancements into normal Department practices:

- Overhead Street Name sign at all new and revised traffic signals.
- Advance Street Name plaques for major intersections.
- Larger and brighter signs.
- Brighter pavement markings and the use of raised pavement markers (RPMs).
- Positive offset for opposing left-turn lanes.
- Protected/prohibited left-turn signal phasing at locations where there are a large number of elderly drivers.

- Longer flashing “Don’t Walk” pedestrian phase based on a walking speed of 3 feet per second in areas with a large number of elderly pedestrians.

### Applicability of the *MUTCD*

In the *Federal Register* on December 14, 2006 (at [71 FR 75111](#)), FHWA revised the language in 23 CFR 655.603(a) to clarify the applicability of the *MUTCD* by defining the phrase “open to public travel,” as used to define the term “public road.”

- The *MUTCD* applies to all toll roads and roads within shopping centers, parking lots, airports, sports arenas, and other similar business and/or recreation facilities that are privately owned but where the public is allowed to travel without access restrictions.
- The *MUTCD* does not apply at military bases and other gated properties where access is restricted, and at private railroad grade crossings.

### Acceptable Abbreviations for Use on Traffic Control Devices

Section 1A.14 of the *MUTCD* provides several tables with acceptable and unacceptable abbreviations for use on traffic control devices (typically signs and pavement markings). [Exhibit 1-1](#) combines Table 1A-1 and Table 1A-2 from the *MUTCD*, and adds several additional abbreviations that are relevant.

### Proprietary Items

When preparing specifications for a project, specifying the use of a brand name is proprietary. Similarly, using one company’s specification that other companies cannot match is also proprietary.

Therefore, when an adequate generic specification cannot be prepared for a traffic control device, specify at least three brand names followed by “or approved equal.” If three brand names are unavailable or if the District or municipality desires a certain brand name, specific approval is necessary. Acquire approval by FHWA for Federal Oversight projects and the Bureau Director for Non-Federal (100 percent State), PennDOT Oversight NHS, and PennDOT Oversight Non-NHS projects.

For projects that involve proprietary items dealing with traffic control devices, submit an approval request to the Director of the Bureau of Maintenance and Operations, similar to the example in the [Chapter 1 Appendix](#).

When submitting a request, provide justification for deviation regarding the use of brand names, include the following information:

1. Letter from local government with justification, if applicable.
2. Reasons why a “generic” material description cannot be used, or at least three companies cannot be specified. Examples of acceptable justifications are:
  - a. The item is essential for synchronization with existing highway facilities and no suitable alternative exists.
  - b. The item is being used for research or for relatively short sections of road for experimental purposes.
  - c. No other items exist that are of acceptable quality.
3. If the item is not integral to construction, indicate the disposition of the item after construction.
4. See Section [4.6](#) for additional justification for traffic signal equipment.

To obtain approval for Federal Oversight projects, Districts are requested to submit the approval request with justification to the Bureau Director for coordination with the FHWA when necessary. The Bureau Director will coordinate with the District concerning the approval/disapproval of the item. The District is responsible to scan and link the approval/disapproval in ECMS. The approval letter should be submitted so that approvals can be obtained before PS&E submittal or project advertisement.

Adherence to the above will ensure that approvals are obtained in a timely manner.

This process is in accordance with 23 CFR 635.411. For further clarification, please reference “*Questions and Answers Regarding Title 23 CFR 635.411*” located at [www.fhwa.dot.gov/programadmin/contracts/011106qa.cfm](http://www.fhwa.dot.gov/programadmin/contracts/011106qa.cfm).

## Laws, Regulations, Forms and Other Publications

Other useful sources of information include the following:

1. *Access to and Occupancy of Highways by Driveways and Local Roads* (67 Pa. Code Chapter 441), which regulates the location, design, construction, maintenance and drainage of access driveways and local roads within State highway right-of-way – available at <http://www.pacode.com/secure/data/067/chapter441/chap441toc.html>, and as PennDOT Publication 441.
2. *Americans with Disabilities Act and Architectural Barriers Act Accessibility Guidelines*, United States Access Board, July 23, 2004 – available at <http://www.access-board.gov/ada-aba/final.pdf>.
3. *Approved Construction Materials – Bulletin 15*, (PennDOT Pub. 35). A listing of approved materials and manufacturers – available at [ftp://ftp.dot.state.pa.us/public/pdf/BOCM\\_MTD\\_LAB/PUBLICATIONS/PUB\\_35/BULLETIN\\_15.pdf](ftp://ftp.dot.state.pa.us/public/pdf/BOCM_MTD_LAB/PUBLICATIONS/PUB_35/BULLETIN_15.pdf).
4. *Clearview Typeface Supplement*, dated September 2, 2004, FHWA – available at [http://mutcd.fhwa.dot.gov/res-ia\\_clearview\\_font.htm](http://mutcd.fhwa.dot.gov/res-ia_clearview_font.htm).
5. *Engineering and Traffic Study Forms* are available at <ftp://ftp.dot.state.pa.us/public/PubsForms/Forms/>
6. *Guidelines for the Maintenance and Operations of Traffic Signals*, PennDOT Pub. 191, 2010 Edition.
7. *Guidelines for the Selection of Supplemental Guide Signs for Traffic Generators Adjacent to Freeways*, 2001 Edition (AASHTO).
8. *Highway Design Handbook for Older Drivers and Pedestrians*, Federal Highway Administration, Publication No. FHWA-RD-01-1-3, May 2001 – available at <http://www.tfrc.gov/humanfac/01103/coverfront.htm#toc>.
9. *Maintenance Manual*, PennDOT Pub. 23, July 2010. See Chapter 15, entitled “Weight Restriction in Highways (Posted Highways)” – available at <ftp://ftp.dot.state.pa.us/public/PubsForms/Publications/PUB%2023/PUB%2023.pdf>.
10. *Manual of Transportation Engineering Studies*, 1994 Edition (ITE).
11. *Manual on Uniform Traffic Control Devices (MUTCD)*, 2009 Edition or latest edition (FHWA) – available at [http://mutcd.fhwa.dot.gov/pdfs/2009/pdf\\_index.htm](http://mutcd.fhwa.dot.gov/pdfs/2009/pdf_index.htm).
12. *Official Traffic-Control Devices*, (67 Pa. Code Chapter 212), a regulation that adopted the *MUTCD* and establishes additional study requirements, warrants, principles and guidelines for the

- Commonwealth, and is available at <http://www.pacode.com/secure/data/067/chapter212/chap212toc.html>. The regulation with an appendix, which contains some additional guidance on engineering and traffic studies, is also available as PennDOT Pub. 212, at <ftp://ftp.dot.state.pa.us/public/PubsForms/Publications/PUB%20212.pdf>.
13. *Pavement Marking Handbook*, an unnumbered PennDOT manual that provides detailed guidance for Department work force in the day-to-day operation of the Department's pavement marking program, including the operation of the truck-mounted and small paint machines.
  14. *Pennsylvania Drivers Manual*, which includes guidance regarding the purpose and meaning of various types of traffic control devices – available at <http://www.dmv.com/pa/pennsylvania/driver-handbook>.
  15. *A Policy on Geometric Design of Highways and Streets, Fifth Edition, 2004 (AASHTO)*. Also known as the "Green Book."
  16. *Project Office Manual or POM (PennDOT Pub. 2)* – available at <http://www.dot.state.pa.us/Internet/Bureaus/pdBOS.nsf/FormsAndPubsHomePage?OpenFrameSet>.
  17. *Recommended Practice for Roadway Sign Lighting, RP-19 01, Sign Lighting Committee of the IESNA Roadway Lighting Committee*, Illuminating Engineering Society (IES).
  18. *Retroreflective Sheeting Identification Guide*, September 2005 (FHWA) – available at [http://safety.fhwa.dot.gov/roadway\\_dept/night\\_visib/sign\\_visib/sheetguide/](http://safety.fhwa.dot.gov/roadway_dept/night_visib/sign_visib/sheetguide/).
  19. *Roadside Design Guide*, latest Edition (AASHTO).
  20. *Roundabouts: An Informational Guide – Second Edition*, NCHRP Report 672 in cooperation with the FHWA, 2010 – available at [www.trb.org/Main/Blurbs/164470.aspx](http://www.trb.org/Main/Blurbs/164470.aspx).
  21. *School Trip Safety Program Guidelines*, 1984 Edition (ITE).
  22. *Specifications (PennDOT Pub. 408)*, detailed specifications for the construction and installation of traffic delineation devices – available at <http://www.dot.state.pa.us/Internet/Bureaus/pdDesign.nsf/ConstructionSpecs408and7?OpenForm>.
  23. *Standard Highway Signs and Markings Book*, (FHWA) – available at [http://mutcd.fhwa.dot.gov/ser-shs\\_millennium.htm](http://mutcd.fhwa.dot.gov/ser-shs_millennium.htm).
  24. *Traffic Control – Pavement Markings and Signing Standards* (PennDOT Pub. 111), PennDOT's 8600 and 8700 series, available at <ftp://ftp.dot.state.pa.us/public/PubsForms/Publications/PUB%20111M.pdf>.
  25. *Traffic Control Devices Handbook*, 2001 Edition (ITE).
  26. *Traffic Engineering Handbook*, 2009 6th Edition (ITE).
  27. *Travel Better, Travel Longer: A Pocket Guide to Improve Traffic Control and Mobility for Our Older Population*, FHWA OP 03 098, 2003 (FHWA) – available online at <http://mutcd.fhwa.dot.gov/pdfs/PocketGuide0404.pdf>.
  28. *Trip Generation Manual*, Latest Edition (ITE).

- 
29. Uniform Vehicle Code (UVC) and Model Traffic Ordinance, 2000 Edition, National Committee on Uniform Traffic Laws and Ordinances.
  30. Vehicle Code (75 Pa.C.S.). Title 75 of the Pennsylvania Consolidated Statutes, which sets forth the laws relative to travel on streets and highways, and specific actions required by the Department. The Vehicle Code is available online at [http://www.dot4.state.pa.us/vehicle\\_code/index.shtml](http://www.dot4.state.pa.us/vehicle_code/index.shtml).
  31. Work Zone Traffic Control (PennDOT Pub. 213), a series of drawings for temporary traffic control – available at <ftp://ftp.dot.state.pa.us/public/PubsForms/Publications/PUB%20213.pdf>.

The Bureau of Maintenance and Operations maintains a comprehensive list of hyperlinks for traffic engineers at [P:\bhste\\_shared\hyperlinks\common-hyperlinks.doc](P:\bhste_shared\hyperlinks\common-hyperlinks.doc). Submit any suggestions for additions or changes to the list to the Chief, Traffic Engineering and Operations Division.



**Exhibit 1-1 Acceptable Abbreviations for Traffic Control Devices**

Word Message	Standard Abbreviation	Required Prompt Word
Access	ACCS	Road, RD
Afternoon / Evening	PM	
Ahead	AHD	Fog*
Air Force Base	AFB	[name]*
Alternate	ALT, Alt	
Avenue	AVE, Ave	
Bicycle	BIKE	
Blocked	BLKD	Lane*, LN*
Boulevard	BLVD, Blvd	
Bridge	BRDG	[Name]*
Cannot	CANT	
CB Radio	CB	
Center	CNTR	
Chemical	CHEM	Spill
Circle	CIR, Cir	
Civil Defense	CD	
Compressed Natural	CNG	
Condition	COND	Traffic*, TRAF*
Congested	CONG	Traffic*, TRAF*
Construction	CONST	Ahead
Court	CT, Ct	
Crossing (other than highway-rail)	XING	
DE Traffic Route	DE	[Number]
Diesel Fuel	D	
Do Not	DONT	
Downtown	DWNTN	Traffic, TRAF
Drive	DR, Dr	
East	E	
Eastbound	E-BND	
Electric Vehicle	EV	
Emergency	EMER	
Entrance, Enter	ENT	

Word Message	Standard Abbreviation	Required Prompt Word
Exit	EX, EXT	Next*
Express	EXP	Lane, LN
Expressway	Expw	
Feet	FT, Ft	
FM Radio	FM	
Freeway	FRWY, FWY	
Friday	FRI	
Frontage	FRNTG	Road, RD
Hazardous	HAZ	Driving
Hazardous Material	HAZMAT	
High Occupancy Vehicle	HOV	
Highway	HWY, Hwy	
Highway-Rail Grade Crossing Pavement Marking	RXR	
Hospital	H	
Hour(s)	HR	
Information	INFO, Info	
Inherently Low Emission Vehicle	ILEV	
Interstate Traffic Route	I-	[Number]
It Is	ITS	
Junction / Intersection	JCT	
Lane	LN	
Left	LFT	
Liquid Propane Gas	LP-GAS	
Local	LOC	Traffic, TRAF
Lower	LWR	Level
Maintenance	MAINT	
Major	MAJ	Accident

Word Message	Standard Abbreviation	Required Prompt Word
MD Traffic Route	CO	[Number]
Mile(s)	MI	
Miles Per Hour	MPH	[Number]*
Minor	MNR	Accident
Minute(s)	MIN	
Monday	MON	
Morning / Late Night	AM	
NJ Traffic Route	NJ	[Number]
Normal	NORM	
North	N	
Northbound	N-BND	
NY Traffic Route	NY	[Number]
OH Traffic Route	OH	[Number]
Oversized	OVRSZ	Load
PA Traffic Route	PA	[Number]
Parking	PKING	
Parkway	PKWY	
Pavement	PVMT	Wet*
Pedestrian	PED	
Place	PL	
Pounds	LBS	
Prepare	PREP	To Stop
Quality	QLTY	Air*
Right	RHT	
Road	RD, Rd	
Roadwork	RDWK	Ahead, [Distance]
Route	RT, RTE, Rte	Best*
Saturday	SAT	
Service	SERV, Serv	
Shoulder	SHLDR	
Slippery	SLIP	
South	S	

Word Message	Standard Abbreviation	Required Prompt Word
Southbound	S-BND	
Speed	SPD	
Street	ST, St	
Sunday	SUN	
Telephone	PHONE, Phone	
Temporary	TEMP	
Terrace	TER	
Thursday	THURS	
Tires With Lugs	LUGS	
Tons of Weight	T	
Township	TWNSHP	Limits
Traffic	TRAF	
Trail	TR	
Travelers	TRAVLRS	
Tuesday	TUES	
Turnpike	TRNPK	[Name]*
Two-Way Intersection	2-WAY	
Two-Wheeled Vehicles	CYCLES	
University	UNIV, Univ	
Upper	UPR	Level
US Traffic Route	US	[Number]
Vehicle(s)	VEH	
Warning	WARN	
Wednesday	WED	
West	W	
Westbound	W-BND	
Will Not	WONT	
WV Traffic Route	WV	[Number]

\* The prompt word should precede the abbreviation

## Definitions

The following words and terms, when used in this chapter, have the following meanings, unless the context clearly indicates otherwise:

ADT – Average daily traffic – The total volume of traffic during a number of whole days, more than 1 day and less than 1 year, divided by the number of days in that period.

Active work zone – The portion of a work zone where construction, maintenance or utility workers are on the roadway or on the shoulder of the highway, and workers are adjacent to an active travel lane. Workers are not considered adjacent to an open travel lane if they are protected by a traffic barrier and no ingress or egress to the work zone exists through an opening in the traffic barrier.

Advisory speed – The recommended speed for vehicles operating on a section of highway based on the highway design, operating characteristics and conditions. When posted, the speed is displayed as a warning sign; that is, either a black-on-yellow or a black-on-orange sign.

Angle parking – Parking, other than parallel parking, which is designed and designated so that the longitudinal axis of the vehicle is not parallel with the edge of the roadway.

Assemblage –

- (i) An organized gathering of people without vehicles, or with vehicles that are stationary, which encroaches onto a street or highway and interferes with the movement of pedestrian or vehicular traffic.
- (ii) The term includes street fairs, block parties and other recreational events.

Bureau – The Bureau of Maintenance and Operations, which is the office of the Department responsible for traffic regulations and statewide policies regarding traffic control devices.

Conventional road, conventional highway – A highway other than an expressway or a freeway.

Corner sight distance –

- (i) Available corner sight distance—The maximum measured distance along a crossing highway which a driver stopped at a side road or driveway along that highway can continuously see another vehicle approaching. For the purpose of measuring the available sight distance, the height of both the driver's eye and the approaching vehicle should be assumed to be 3.5 feet above the road surface. In addition, the driver's eye should be assumed to be 10 feet back from the near edge of the highway or the near edge of the closest travel lane if parking is permitted along the highway.
- (ii) Minimum corner sight distance—The minimum required corner sight distance based on engineering and traffic studies, to ensure the safe operation of an intersection. The minimum value is a function of the speed of the approaching vehicles and the prevailing geometrics.

Crash –

- (i) A collision involving one or more vehicles.
- (ii) Unless the context clearly indicates otherwise, the term only includes those collisions that require a police report; that is, the collision involves one of the following:
  - Injury to or death of any person.
  - Damage to any vehicle involved to the extent that it cannot be driven under its own power in its customary manner without further damage or hazard to the vehicle, to other traffic elements, or to the roadway, and therefore requires towing.

*Delineator* – A retroreflective device mounted on the road surface or at the side of the roadway in a series to indicate the alignment of the roadway, especially at night or in adverse weather.

*Department* – The Department of Transportation of the Commonwealth.

*Divided highway* – A highway divided into two or more roadways and so constructed as to impede vehicular traffic between the roadways by providing an intervening space, physical barrier or clearly indicated dividing section.

*85th percentile speed* – The speed on a roadway at or below which 85 percent of the motor vehicles travel.

*Engineering and traffic study* – An orderly examination or analysis of physical features and traffic conditions on or along a highway, conducted in accordance with this chapter for the purpose of ascertaining the need or lack of need of specific traffic restrictions, and the application of traffic control devices.

*Expressway* – A divided arterial highway for through traffic with partial control of access and generally with grade separations at major intersections.

*Freeway* – A limited access highway to which the only means of ingress and egress is by interchange ramps.

*Grade* – The up or down slope in the longitudinal direction of the highway, expressed in percent, which is the number of units of change in elevation per 100 units of horizontal distance. An upward slope is a positive grade; a downward slope is a negative grade.

*Highway* –

- (i) The entire width between the boundary lines of every way publicly maintained when any part thereof is open to the use of the public for purposes of vehicular travel.
- (ii) The term includes a roadway open to the use of the public for vehicular travel on grounds of a college or university, or public or private school, or public or historical park.

Local authorities –

- (i) County, municipal and other local boards or bodies having authority to enact regulations relating to traffic.
- (ii) The term includes airport authorities except when those authorities are within counties of the first class or counties of the second class.
- (iii) The term also includes State agencies, boards and commissions other than the Department, and governing bodies of colleges, universities, public and private schools, public and historical parks.

*MUTCD* – The current edition of the Manual on Uniform Traffic Control Devices, as adopted by the Federal Highway Administration (FHWA), and available on their website.

*Narrow bridge or underpass* – A bridge, culvert or underpass with a two-way roadway clearance width of 16 to 18 feet, or any bridge, culvert or underpass having a roadway clearance less than the width of the approach travel lanes.

*Night, nighttime* – The time from 1/2 hour after sunset to 1/2 hour before sunrise.

*Normal speed limit* – The regulatory speed limit or the 85th percentile speed that existed before temporary traffic control was established, for example, prior to the beginning of a work zone.

*Numbered traffic route* – A highway that has been assigned an Interstate, United States or Pennsylvania route number, consisting of one, two, or three digits, sometimes with an additional designation such as business route, truck route or other similar designation.

Private parking lot – A privately owned parking lot open to the public for parking with or without restriction or charge.

Procession –

- (i) An organized group of individuals, or individuals with vehicles, animals or objects, moving along a highway on the roadway, berm or shoulder in a manner that interferes with the normal movement of traffic.
- (ii) The term includes walks, runs, parades and marches.

Retroreflective sheeting –

- (i) Material which allows a large portion of the light coming from a point source to be returned directly back to a location near its origin, and is used to enhance the nighttime reflectivity of traffic control signs, delineators, barricades and other devices.
- (ii) The term includes materials with enclosed glass bead lens and microprismatic retroreflective sheeting.

Roadway – That portion of a highway improved, designed or ordinarily used for vehicular travel, exclusive of the sidewalk, berm or shoulder. If a highway includes two or more separate roadways, the term refers to each roadway separately but not to all roadways collectively.

Safe-running speed – The average speed for a portion of highway determined by making a minimum of five test runs while periodically recording the speed at different locations while driving at a speed which is reasonable and prudent, giving consideration to the available corner and stopping sight distance, spacing of intersections, roadside development and other conditions.

School – A public, private or parochial facility for the education of students in grades kindergarten through 12.

School zone – A portion of a highway that at least partially abuts a school property or extends beyond the school property line that is used by students to walk to or from school or to or from a school bus pick-up or drop-off location at a school.

Secretary – The Secretary of the Department.

Special activity –

- (i) An organized vehicle race, speed competition or contest, drag race or acceleration contest, test of physical endurance, exhibition of speed or acceleration, or any other type of event conducted for the purpose of making a speed record.
- (ii) The term includes those races defined in 75 Pa.C.S. §3367 (relating to racing on highways).

State-designated highway, State highway – A highway or bridge on the system of highways and bridges over which the Department has assumed or has been legislatively given jurisdiction.

Stopping sight distance – The length of highway over which a 2-foot high object on the roadway is continuously visible to the driver, with the driver's eye height assumed to be 3.5 feet above the road surface.

TTC, temporary traffic control – An area of a highway where road user conditions are changed because of a work zone or incident by use of temporary traffic control devices, flaggers, police officers or other authorized personnel.

TTC plan – A plan for maintaining traffic through or around a work zone.

Through highway –

- (i) A highway or portion of a highway on which vehicular traffic is given preferential right-of-way, and at the entrances to which vehicular traffic from intersecting highways is required by law to yield the right-of-way in obedience to a STOP (R1-1) sign, YIELD (R1-2) sign or other traffic control device when the signs or devices are erected as provided in this chapter.
- (ii) The term includes all expressways and freeways.

Traffic calming – The combination of primarily physical measures taken to reduce the negative effects of motor vehicle use, alter driver behavior and improve conditions for non-motorized street users. The primary objectives of traffic calming measures are to reduce speeding and to reduce the volume of cut-through traffic on neighborhood streets.

Traffic control devices – Signs, signals, markings and devices consistent with this chapter placed or erected by authority of a public body or official having jurisdiction, for the purpose of regulating, warning or guiding traffic.

Traffic restriction – A restriction designated by a traffic control device to regulate the speed, direction, movement, placement or kind of traffic using any highway.

Traffic signal –

- (i) A power-operated traffic control device other than a sign, warning light, flashing arrow panel or steady-burn electric lamp.
- (ii) The term includes traffic control signals, pedestrian signals, beacons, in-roadway warning lights, lane-use-control signals, movable bridge signals, emergency traffic signals, firehouse warning devices, ramp and highway metering signals and weigh station signals.

Travel lane –

- (i) A lane of a highway which is used for travel by vehicles.
- (ii) A lane in which parking is permitted during off-peak hours but is restricted for use as a travel lane during peak hours to obtain greater traffic movement.

Warrant – A description of the threshold conditions to be used in evaluating the potential safety and operational benefits of traffic control devices based upon average or normal conditions.

Work zone – The area of a highway where construction, maintenance or utility work activities are being conducted, and in which traffic control devices are required in accordance with this chapter

## 1.2 Chapter 1 Appendix

### Proprietary Item Approval Request Sample Letter

Blank Form <P:\penndot shared\FORMS PennDOT Authorized\OS-600.dot>

OS-2 (11-08)



DATE: "[Enter Date Here]"

SUBJECT: SR[SR] Section [Sec] ECMS # [ECMS]  
Proprietary Item Approval Request

To: "[Enter Bureau Director Name here]" ,P.E.  
Director  
Bureau of "[Enter Bureau here]"

FROM: "[Enter Name here]"  
District Executive  
Engineering District XX-0

We are providing the following information for Proprietary Item Approval.

[INSERT A SHORT PROJECT DESCRIPTION]

[INSERT THE PROPRIETARY ITEMS AND A JUSTIFICATION (in accordance with 23CFR and Publication 51, Chapter 3 Section B)]

*(This is a sample justification. Please incorporate the appropriate CFR references (1, 2, or 3) and justifications pertaining to your proprietary item request.)*

*The items that we seek approval for are:*

*1. [Insert Item]*

*This request is in compliance with the Code of Federal Regulations Title 23 – Highways, Part 635- Construction and Maintenance, Subsection 411 – Material or product selection. These items were selected to maintain (system continuity and/or unavailability of alternate same product) with the current products used by the (municipality/township/city).*

[INSERT THESE PARAGRAPHS]

This project (is / is not) a Federal oversight project, therefore it (should / should not) be forwarded to FHWA for approval.

The District concurs with the justification provided herewith (by the municipality/township/city) and requests your approval for the subject proprietary item(s).

If you have any questions on this matter or require any additional information, please contact, (Name) at (###) ###-####.

Attachment(s)

Approval \_\_\_\_\_ Date \_\_\_\_\_  
Director, Bureau of "[Enter Bureau Here]"

Engineering District XX-0 | Address | City, PA \_\_\_\_ | (\_\_\_\_) \_\_\_\_-\_\_\_\_

Exhibit 3A Example Template letter for Proprietary Item Approval.



## Access Route Approval – Expanded Access

### References

#### Administrative Law and Procedures. (2 Pa. C.S.).

- a) § 501, Scope of subchapter.
- b) § 551, Scope of subchapter.
- c) Chapter 7, Judicial Review.

#### The Pennsylvania Vehicle Code. (75 Pa. C.S.).

- a) § 102, Definitions.
- b) § 1943, Annual hauling permit.
- c) § 4904, Limits in number of towed vehicles.
- d) § 4908, Operation of certain combinations on interstate and certain primary highways.
- e) § 4921, Width of vehicles.
- f) § 4923, Length of vehicles.
- g) § 4968, Permit for movement during course of manufacture.

#### Requests for Reasonable Access to the Designated Network. (67 Pa. Code, Ch. 209)

### Background

#### Federal Legislation and Regulations.

Federal legislation and regulations prohibits any state from establishing, maintaining, or enforcing a regulation of commerce which imposes a maximum vehicle combination length or a vehicle length limitation of less than 48 feet on the length of a single semi-trailer, or 28 feet on the length of a trailer operated in a semi-trailer, trailer combination, or a vehicle width more or less than 102 inches on Interstate highways and selected Federal aid primary highways.

Refer to FHWA Title 23 part 658.19 Reasonable Access found at:

<http://ecfr.gpoaccess.gov/cgi/t/text/text-idx?c=ecfr&sid=4326b3462801c075d9d260366f1f811e&rgn=div5&view=text&node=23:1.0.1.7.33&idno=23>

## PROCEDURE FOR EXPANDED ACCESS

### Requestor

The owner/operator of a motor carrier or terminal submits a written request to the Pennsylvania Department of Transportation, Bureau of Maintenance and Operations, Harrisburg, Pennsylvania 17120, or to a city or other municipality if the request is for routes within a city or for local roads. Information required of the carrier or the owner/operator of the terminal at the time of the request is:

- 1) Location of terminal (street or roadway address and sketch or map showing the location of the terminal and proposed route to be used).

- 2) The designated network route or approved access route from which access is being requested and a listing of the streets or highways (by Traffic Route number, name, or other identification) and the mileage along each street or highway between the designated network or approved access route and the terminal.
- 3) Type(s) of vehicle or combination to be used and the anticipated daily volume by type of vehicle or combination.

**Department**

- a) Bureau of Maintenance and Operations.

The Bureau of Maintenance and Operations will review the request to determine if adequate information on the location of the terminal and proposed access routes has been submitted. If adequate information has been submitted, the request will be acknowledged and transmitted to the appropriate Engineering District(s). If adequate information has not been submitted, the requestor will be advised by letter and asked to submit additional data.

- b) Engineering Districts.

- 1) The Engineering District(s) will conduct an access route review and will coordinate with the involved local governments if any of the requested routes must be approved by a city or other municipality. A suggested form letter to submit access route requests to municipalities is shown in [Exhibit 1-2](#) (the District may also wish to include a copy of 67 Pa. Code, Chapter 209 in the package they send the municipalities).
- 2) The access route review will examine roadway/bridge characteristics; traffic, including existing truck usage; accident data; ramp and intersection geometrics; and adjacent land use. The review will be conducted using in-house data and data obtained from the field view. The District and/or involved local government can request a carrier or terminal owner/operator to provide test runs with the types(s) of vehicle combinations to be used if the office and field review of the route does not conclusively determine that the requested types of vehicles should be able to safely use the route.
- 3) A change in highway conditions, subsequent to a denial or approval, could alter a routes status and require another review of the route.

**Exhibit 1-2 Form Letter to Municipalities**

To \_\_\_\_\_:

Please find attached a request for reasonable access to the designated network established by the Surface Transportation Assistance Act. This route includes highways through your municipality. Therefore, action is required by your municipality on this request.

Please be so kind as to review the request and make a determination concerning whether it will be approved or denied. Pursuant to the Regulations found at 67 Pa. Code Section 209.1 et seq., your municipality MUST ACT within thirty (30) days of receipt of this request. Should you fail to act within thirty (30) days of receipt of this request, the request shall be deemed approved by your municipality. In the event your municipality decides to disapprove or restrict approval of this request for reasonable access, you municipality must do so in writing, with an explanation of the reasons for such disapproval or restricted approval.

Should you require information on the characteristics of the vehicles requesting access on your highways, kindly contact \_\_\_\_\_ and it will be forwarded to you.

Should your municipality require an additional fifteen (15) days, such additional time is available under the conditions set forth at 67 Pa. Code Section 209.3(b).

If you have any questions, call \_\_\_\_\_ at \_\_\_\_\_.

Thank you for your cooperation.

Very truly yours,

**Approval or Denial**

- a) In compliance with 67 Pa. Code, Chapter 209, any request for route approval shall be either approved as submitted, approved with additional listed restrictions upon operation, or disapproved in writing within 30 days of receipt by the Department, or the relevant city or municipality as follows:
  - 1) If the requested route requires the approval of the Department and one or more municipalities, the 30-day period for review by a municipality shall commence upon receipt of the request by the municipality. The 30-day period for review by the Department shall commence upon receipt of approval or disapproval from all municipalities involved, or expiration of the municipalities' 30-day period for review, whichever comes first. IN NO EVENT WILL THIS PROCESS TAKE LONGER THAN 90 DAYS WITHOUT THE CONSENT OF THE APPLICANT.
  - 2) The period of time provided for review of applications may be extended by written notice to the applicant for any period of time agreed upon by the applicant and the Department or the relevant city or municipality, or for 15 days without agreement of the applicant for good cause stated in the notice to the applicant.

- b) Any application not approved or disapproved within the time periods stated in (a) above shall be deemed approved by the Department or the relevant city or municipality. Suggested forms for record keeping of applications are shown in [Exhibit 1-3](#) and [Exhibit 1-4](#). As noted, these are suggested forms and any alternative ticket or tracking system may be used, however some system must be utilized.
- c) All approvals, disapprovals, or restricted approvals of applications by the Department and in accordance with 67 Pa. Code, Chapter 209, all disapprovals or restricted approvals by a city or municipality shall be in writing. All disapprovals or restricted approvals shall explain the reasons for the disapproval or restricted approval of the application.
- d) The decision of the Department or of the relevant city or municipality may be reviewed by filing a request with the agency to conduct a hearing and issue an adjudication pursuant to the Administrative Agency Law, 2 Pa. C.S. 501, et seq., or the Local Agency Law, 2 Pa. C.S. 551, et seq. Adjudication shall be subject to judicial review pursuant to 2 Pa. C.S. Chapter 7.

### Processing of Approvals and Denials

- a) Engineering Districts.
  - 1) Based on the review of route conditions and results of test runs (if required), the District transmits a signed letter to the Bureau of Maintenance and Operations recommending approval or disapproval of the route request. If disapproval or a restricted approval is recommended, the reasons for disapproving the request or the restricted approval must be included in the letter. If approval is recommended, the District's submission shall include:
    - The type truck combinations being approved for the route(s).
    - The route(s) identification by US or PA Traffic Route Number and/or local street names and SR number, Segments, and offsets for State highways.
    - The route description(s) from the designated network or approved access route to the terminal.
    - The length of each route in tenths of a mile.
    - The name and address of each municipal police chief to be notified of the route approval.
    - A map or sketch showing the approved route(s) in color.
    - Copy of municipality approval if local action is required. A typical access route approval form is shown in [Exhibit 1-5](#).
  - 2) The District can recommend access route approval for 102 inch wide vehicles/loads only; or combinations with two trailers only, or combinations over 60 feet in length with a single trailer only (48 foot maximum trailer length) or any combination of these types of vehicles. The District may, but is not required to suggest an acceptable alternate route if the requested access route is denied.
  - 3) If action by a city or other municipality is required, the District will include a copy of the municipality's action in its correspondence to the Bureau of Maintenance and Operations or indicate that they have been unable to get an official indication from the municipality relative to the use of the local roads (all roadways within a city).

**Exhibit 1-3 Central Office Form for Access Route Requests**

<b>Central Office Form for Access Route Requests</b>	
REQUESTOR	
ROUTE	
DATE REC'D BY DEPT.	
DATE FOR'D TO DISTRICT	
DATE REC'D FROM DISTRICT	
DATE OF NOTICE TO REQUESTOR	

**Exhibit 1-4 District Form for Access Route Requests**

<b>District Form for Access Route Requests</b>							
REQUESTOR	ROUTE	DATE REC'D BY DEPT.	MUNICIPALITY	DATE FOR'D TO MUN.	DATE REC'D FROM MUN.	EXTENSION	DATE OF REPLY TO CENTRAL OFFICE

Exhibit 1-5 Access Route Approval Forms

PENNSYLVANIA DEPARTMENT OF TRANSPORTATION

ACCESS ROUTE APPROVAL

Under the provisions of 75 Pa. C.S. S4908 the Department of Transportation on \_\_\_\_\_ approved the following access routes(s) for use by the types of truck combinations identified in the appropriate boxes:

- 96-inch wide
- 102-inch wide
- Two-trailer vehicle combination
- Single trailer vehicle combinations exceeding 60 feet in length.

Note: Single-trailers in combinations longer than 60 feet may not exceed 48 feet in length.

<u>Route Identification</u>	<u>Route Description</u>	<u>Length Miles</u>
-----------------------------	--------------------------	---------------------

PEN4NSYLVANIA DEPARTMENT OF TRANSPORTATION

ACCESS ROUTE APPROVAL

Under the provisions of 75 Pa. C.S. S4908 the Department of Transportation on \_\_\_\_\_ approved the following access routes(s) for use by the types of truck combinations identified in the appropriate boxes:

- 96-inch wide
- 102-inch wide
- Two-trailer vehicle combination
- Single trailer vehicle combinations exceeding 60 feet in length.

Note: Single-trailers in combinations longer than 60 feet may not exceed 48 feet in length.

The following municipality (ies) approved the access route(s) within their jurisdiction(s):

	<u>Municipality (ies)</u>	
<u>Route Identification</u>	<u>Route Description</u>	<u>Length Miles</u>

## b) Central Office.

- 1) The Bureau of Maintenance and Operations will notify the requester of an access route approval or official action taken. If the request is denied the major reasons for denial will be-listed. If the request is approved, the routes will be identified and the effective date of approval will be indicated. In addition to approvals, the Bureau will:
  - Publish approved State highways outside of cities in the Pennsylvania Bulletin. This will include mileage and origin/termination points. The Bureau will also publish approved local roads and roadways within a city if the Department also approves part of the access route; however, when the complete access route approval is the responsibility of a city or local municipality, it will be their responsibility to have the approval published in the Pennsylvania Bulletin should send their notices and requests to print notices to the Districts. The Districts will then send the municipality's notice to Central Office.
  - Provide access route approval information to the PA State Police, local Police Departments, FHWA, Transport Topics, PMTA, and other trucker related agencies.
  - Maintain a current approved access route network on maps and a tabulation of approved access routes by types of vehicles authorized to use the routes.
  - Maintain a central file of requests and District approval/disapproval recommendations.
- 2) The Department will monitor the safety experience of the designated network relative to longer-combination trailer operations and make adjustments as may be required with the concurrence of the Federal Highway Administration.

**Guidelines for Reviews**

- a) The Department's review of proposed access routes is for the purpose of determining whether or not the route can safely and reasonably accommodate vehicle combinations with two trailers, vehicle combinations over 60 feet in length with a single trailer (48 foot maximum trailer length), or vehicles 102 inches in width. As previously stated, a route may be approved for all of these types of vehicles and combinations or for designated types of vehicles and combinations only. If the route cannot be approved, the request must be denied.
- b) Each section of a proposed access route should be evaluated subjectively utilizing the evaluator's personal knowledge of the route, field observations, and test runs (if required). This subjective evaluation should be supplemented with highway geometric data, data on accident experience, traffic volume, existing truck usage of the route, etc. It may be obvious on certain routes that the addition of the new classes of truck combinations to the mainstream can be accomplished relatively safely. On the other hand, the use of some portions of state highways by the new types of vehicles may not be feasible due to the failure of portions of the highway system to provide the roadway geometry required by vehicles which are wider and have a longer wheelbase.
- c) In general, as the length of the vehicle's wheelbase increases the amount of off-tracking that it exhibits on any given radius curve also increases. On very short radius curves, a trailer with a wheelbase of 40 feet (which may be typical on a 48' long single trailer) will exhibit a range of off-tracking values from 4 feet to 20 feet as the radius decreases from 250 feet to 25 feet. By contrast, the WB-50 design vehicle with an effective wheelbase of 28 feet exhibits a range of off-tracking



values from 1.8 feet to 10 feet for the same turning radii. Longer trailers with longer wheelbases will exhibit a greater tendency to encroach on the shoulder, sidewalk -or adjacent lanes - especially on narrow roads and/or those roadways containing severe horizontal curvature.

- d) Tracking characteristics of two trailer vehicle combinations are as good or better than the WB-50 design vehicle. This vehicle combination does, however; exhibit one characteristic-which should be of concern. This characteristic is that twin trailers pose a unique safety risk based on the susceptibility to rollover of the rear trailer. This tendency is a direct and inherent result of its design. Because of this, a typically loaded twin trailer combination traveling at 55 mph needs a longer distance and time to clear an obstacle without rolling over than would a comparably loaded semitrailer combination.
- e) Additional items which may be of concern relative to longer vehicle combinations such as two trailer vehicle combinations and single trailer vehicle combinations over 60 feet in length are:
  - 1) During lane changes, a driver of a lengthy vehicle tends to have blind spots at or near the rear of the vehicle and on the right side of the vehicle.
  - 2) Longer vehicles require more time to change lanes and require a longer gap in the traffic into which it must merge.
  - 3) Longer vehicles increase the potential for accidents on slip ramps.
  - 4) A lengthy vehicle can overload a left turn lane, requiring it and/or other vehicles to extend into through traffic lanes.
  - 5) On two lane highways, the longer the passing vehicle and/or the vehicle being passed, the longer the distance and time the passing vehicle will be in the lane of oncoming traffic.
- f) During your review of a proposed access route, it is suggested that you consider the following:
  - 1) In general, the Department believes that 102 inch wide vehicle combinations can be permitted to operate on the majority of the State highway system.
  - 2) If single trailer combination trucks comparable to the WB-50 design vehicle are presently operating on the route under consideration without substantial safety or operating problems, twin trailer combinations can be expected to operate in a similar manner.
  - 3) Off-tracking increases as speed increases. Therefore, a short radius curve at a location where high speeds are expected may be more critical than one located in an area where speeds will be lower.
  - 4) At intersections, the departure lane width is as important a consideration as the turning radius. A narrow departure lane width may force a left turning vehicle to begin its turn from a point to the right of the left turn lane, or may require vehicles on the left side approach to stop considerably back of the stop bar. In addition, the intersection hardware (signs, signal poles, etc.) may be in jeopardy if located near the edge of pavement.
  - 5) The structural capacity of shoulders in areas of sharp curvature/narrow lane widths should be determined. Shoulder encroachment in these areas may create shoulder drop-off and the potential for tire blowouts and/or erratic maneuvers.
  - 6) Because of their tendency to undergo lateral acceleration during steering maneuvers, vehicle combinations with two trailers may experience difficulties in utilizing routes which require high speed lane changes.

- g) The above items are not intended to be all inclusive but should be considered in the process of reviewing route access requests. If, after analyzing all the pertinent data, you are unsure of the route's ability to be safely utilized by the requested vehicles, you may wish to require that the requestor provide a test vehicle, of the size and dimensions intended for use on the route. Under your direction, the test vehicle should be driven, by the driver they supply, over the proposed route as many times as you feel necessary to make a final decision. The test runs should be made at the normal operating speed along the route and at time periods when typical traffic exists. You may wish to record the test runs on video in order to study the test runs and to provide future documentation of the operation of the specific class of vehicle over the route.

#### **Emergency Detours**

- a) The Office of Chief Counsel has determined that police authority exists to re-route the longer and wider vehicle combinations from the approved National Truck Network onto temporary detours during periods of temporary emergencies. They have suggested to the State Police that prior to re-routing these vehicles onto "detour" routes, they should contact the District Engineering Office to verify there are no bridges on the proposed detour routes that have weight and/or width restrictions; curves with small radii that would cause larger size trucks to seriously encroach into the opposing traffic lanes; and intersections where turning maneuvers could not be safely negotiated.
- b) The Engineering District's review and/or knowledge of the proposed detour route may indicate that only certain types of the longer and wider vehicle combinations be permitted to use the proposed detour.
- c) The decision to re-route the longer and wider vehicles is to be made by the State Police. It has been suggested that they consider the estimated length of time of the emergency and whether or not it would be safe to park the larger trucks at the location of the detour.

## CHAPTER 2 - SIGNING

### 2.1 Signing Overview

#### Purpose

One cannot over emphasize the importance of good signing since national studies indicate that deficient signing is the number one complaint of 60 percent of drivers and is the third leading cause of crashes. In addition, sign improvements have one of the highest benefit-to-cost ratio of all safety improvements.

The purpose of this chapter is to consolidate policies for the application, installation and maintenance of traffic signs either by reference or by inclusion herein.

#### Classification of Signs

As noted in Section 2A.05 of the *MUTCD*, there are only three classifications of signs:

- A. Regulatory signs give notice of traffic laws or restrictions.
- B. Warning signs give notice of a situation that might not be readily apparent.
- C. Guide signs show route designations, destinations, directions, distances, services, points of interest and other geographical, recreational, or cultural information.

#### Design of Signs

The primary purpose of the *MUTCD* is to improve safety and reduce driver frustration by promoting uniformity in the design and application of traffic control devices. FHWA is also working internationally to share and borrow ideas so that uniformity is much broader than just in the United States.

Uniform designs and applications of traffic signs help everyone, because as drivers we can see and understand the sign messages, and the systematic advance placement of warning signs provide sufficient notice for us to take appropriate actions.

To that end, the *MUTCD* establishes the basic framework for the design and application of signs, and the *Standard Highway Signs and Markings* book provides detailed drawings of the standard signs and alphabets.

The *MUTCD* also states in Section 2A.06:

“Except as provided in Paragraph 16 and except for the Carpool Information (D12-2) sign (see Section 2I.11), Internet addresses and e-mail addresses, including domain names and uniform resource locators (URL), shall not be displayed on any sign, supplemental plaque, sign panel (including logo sign panels on Specific Service signs), or changeable message sign.”

#### Sign Nomenclature

The *MUTCD* assigns a unique nomenclature to all common types of traffic signs. PennDOT uses the nomenclature in the *MUTCD*, but like other states, PennDOT also has some additional traffic signs that they have approved for unique applications, and for which they have assigned their own nomenclature. The first letter in sign nomenclature conforms to the following:

- Regulatory signs – R.
- Warning signs – W, except school signs start with the letter S.

- Guide signs – a variety of letters, but most commonly D, G, I, or M.

Sign names used in this manual may look awkward because some are in all capital letters while others are in title case. This mix of styles is common because the *MUTCD* and most other sign manuals generally use the following practice:

1. Uppercase legends (capitals) for sign names when the sign name and the sign legend message are the same (e.g., STOP, YIELD, and DO NOT ENTER signs).
2. Title case for symbol signs and whenever the sign name and sign message are not the same (e.g., Speed Limit, Turn, and Intersection signs).

What is Retroreflectivity?

The *MUTCD* requires traffic signs to be either retroreflective or illuminated to show the same shape and color both day and night. Since it is more cost effective to make signs retroreflective than it is to illuminate them, PennDOT requires retroreflective sheeting material on all signs.

Most objects reflect light. The most common type of reflection is “diffuse reflection” where light scatters after striking rough surfaces such as trees, clothing and carpet. Only a very small amount of the diffused light reflects back toward the light source.

Another type of reflection is “mirror reflection” that occurs when light strikes smooth or glossy surfaces, and the light reflects off the surface at an equal but opposite angle. Mirror reflection frequently occurs at night on wet roads when the headlights of approaching vehicles create extensive glare. Sign faces also produce some mirror reflection due to their glossy surfaces, and for this reason; it is a good practice to rotate signs away from the driver.

In contrast, “retroreflection” (see [Exhibit 2-1](#)) is the unique ability of a surface to reflect light back toward the light source, and “retroreflectivity” is the measurable property of a material to redirect light back to its source.

**Exhibit 2-1 Types of Retroreflection**

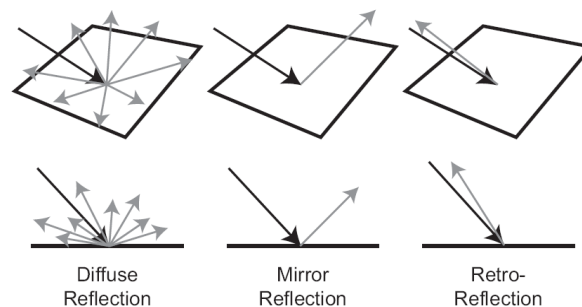

Retroreflective Sheeting Materials

To make signs retroreflective, sign manufacturers apply retroreflective sheeting, which contains either microscopic glass beads or cube corner reflectors, to the face of each sign. If the sheeting manufacturers could make all glass beads and cube corner reflectors perfectly shaped, all reflected light would return directly to the light source (headlights). Although retroreflective sheeting does not have perfectly shaped lenses, drivers do see more reflected light the closer their eyes are to the headlights. As illustrated in [Exhibit 2-2](#), the angle formed between the headlights, the sign and the driver’s eyes is the observation angle, and the smaller the angle the higher the retroreflectivity.

**Exhibit 2-2 Graphic Illustration of the Observation Angle**

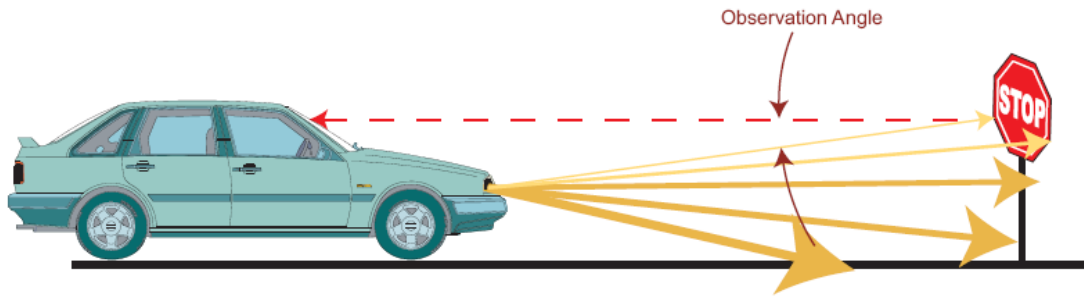

Retroreflective materials are also more efficient when the light source is approximately perpendicular to the sign face; therefore, it is important to have signs oriented to face approaching traffic.

The ability to see traffic signs at night is a function of the following:

- Driver’s night vision.
- Intensity and light distribution of the headlights.
- Distance, mounting height, and orientation of the sign in relation to the vehicle’s headlights.
- Location of driver’s eyes with respect to the headlights.
- Type, color and age of the retroreflective material.

Why is Retroreflectivity Important?

The nighttime visibility of signs and pavement markings is essential for highway safety. National studies show that 50 percent or more of all fatal crashes occur at night despite lower travel volumes. In fact, the average fatality rate (fatalities per 100 million vehicle-miles of travel) is about three times higher during the night than during the day.

Some of the factors that contribute to higher nighttime crash rates include:

- After age 20, the human eye needs about twice as much light approximately every 12 years in order to read. For example, compared to a 20-year old driver, a 32-year old driver needs twice as much light, a 44-year old driver needs four times as much light, a 56-year old driver needs eight times as much light, and a 68-year old driver needs 16 times as much light.
- The number of visual clues that delineate the roadway alignment are reduced at night.
- Glare from opposing traffic further reduces the number of visual clues.
- Rain, snow, fog, dew and frost reduce visibility distances.
- There are more intoxicated and sleepy drivers.

Some traffic signs may look almost new during the day but are completely ineffective at night. This nighttime visibility problem is usually a function of the type and age of the retroreflective material.

Initially, only one type of retroreflective sheeting material was available, but as technology developed, brighter and more durable materials became available. **Exhibit 2-3** shows eight types of retroreflective materials currently manufactured for permanent-type signs, and new more-efficient types are rapidly evolving. Please note that Types V and VI sheeting are not included because they are not for permanent signs (Type V sheeting is for delineation and Type VI sheeting is for temporary roll-up signs).

**Exhibit 2-3 Retroreflective Materials for Permanent Signs**

Type Retroreflective Material	Common Name	Life Expectancy (years)	General Comments
<del>I</del>	<del>Engineering Grade</del>	<del>7</del>	<b>These two types of materials are no longer approved for use</b>
<del>II</del>	<del>Super-Engineering Grade</del>	<del>7-10</del>	
III	High-Intensity Grade	10+	Encapsulated lens or microprismatic materials
IV	High-Performance Grade	10+	Microprismatic materials
VII, VIII, IX, X & XI	Super-High Intensity or Very High Intensity Grades	12+	Microprismatic materials

When is Sign Lighting Required?

In 1993, PennDOT started using Type III or higher type retroreflective sheeting for all new traffic signs. Because the Department has elected to use higher types of retroreflective sheeting materials, the need for sign lighting should be minimal. In general, consider sign lighting only for overhead freeway signs as discussed in the section [Overhead Signs](#) on page 2-72.

**Minimum Retroreflectivity**

In 1993, Congress directed the U.S. Secretary of Transportation to include minimum retroreflectivity values for traffic signs in the *MUTCD*. Following extensive research and public input, FHWA adopted minimum retroreflectivity values for most traffic signs on December 21, 2007, and incorporated them into the *MUTCD* (Revision 2 of the 2003 Edition). Specifically, Section 2A-09 and Table 2A-1 of the *MUTCD* contain the new criteria. Table 2A-1 is included herein as [Exhibit 2-4](#).

The Department discontinued using Type I (Engineering Grade) and Type II (Super Engineering Grade) materials in 1993, but most local authorities continued using these materials. However, in 2004, the Department canceled the approvals of all Type I and Type II materials because: (1) the Department was aware of the on-going research; and (2) the fact that the higher grade materials were more cost effective than the cheaper materials. **Therefore, no new signs are to be installed using Type I or Type II materials on any public highway within the Commonwealth.**

**Exhibit 2-4 Minimum Maintained Retroreflectivity Levels**

Sign Color	Sheeting Type (ASTM D4956-04)				Additional Criteria
	Beaded Sheeting			Prismatic Sheeting III, IV, VI, VII, VIII, IX, X	
	I	II	III		
White on Green	W*; G ≥ 7	W*; G ≥ 15	W*; G ≥ 25	W ≥ 250; G ≥ 25	Overhead
	W*; G ≥ 7	W ≥ 120; G ≥ 15			Post-mounted
Black on Yellow or Black on Orange	Y*; O*	Y ≥ 50; O ≥ 50			2
	Y*; O*	Y ≥ 75; O ≥ 75			3
White on Red	W ≥ 35; R ≥ 7				4
Black on White	W ≥ 50				—
<sup>1</sup> The minimum maintained retroreflectivity levels shown in this table are in units of cd/lx/m <sup>2</sup> measured at an observation angle of 0.2° and an entrance angle of -4.0°.					
<sup>2</sup> For text and fine symbol signs measuring at least 48 inches and for all sizes of bold symbol signs					
<sup>3</sup> For text and fine symbol signs measuring less than 48 inches					
<sup>4</sup> Minimum sign contrast ratio ≥ 3:1 (white retroreflectivity ÷ red retroreflectivity)					
* This sheeting type shall not be used for this color for this application.					
Bold Symbol Signs					
<ul style="list-style-type: none"> <li>• W1-1,2 – Turn and Curve</li> <li>• W1-3,4 – Reverse Turn and Curve</li> <li>• W1-5 – Winding Road</li> <li>• W1-6,7 – Large Arrow</li> <li>• W1-8 – Chevron</li> <li>• W1-10 – Intersection in Curve</li> <li>• W1-11 – Hairpin Curve</li> <li>• W1-15 – 270 Degree Loop</li> <li>• W2-1 – Cross Road</li> <li>• W2-2,3 – Side Road</li> <li>• W2-4,5 – T and Y Intersection</li> <li>• W2-6 – Circular Intersection</li> <li>• W2-7,8 – Double Side Roads</li> </ul>		<ul style="list-style-type: none"> <li>• W3-1 – Stop Ahead</li> <li>• W3-2 – Yield Ahead</li> <li>• W3-3 – Signal Ahead</li> <li>• W4-1 – Merge</li> <li>• W4-2 – Lane Ends</li> <li>• W4-3 – Added Lane</li> <li>• W4-5 – Entering Roadway Merge</li> <li>• W4-6 – Entering Roadway Added Lane</li> <li>• W6-1,2 – Divided Highway Begins and Ends</li> <li>• W6-3 – Two-Way Traffic</li> <li>• W10-1,2,3,4,11,12 – Grade Crossing Advance Warning</li> </ul>		<ul style="list-style-type: none"> <li>• W11-2 – Pedestrian Crossing</li> <li>• W11-3,4,16-22 – Large Animals</li> <li>• W11-5 – Farm Equipment</li> <li>• W11-6 – Snowmobile Crossing</li> <li>• W11-7 – Equestrian Crossing</li> <li>• W11-8 – Fire Station</li> <li>• W11-10 – Truck Crossing</li> <li>• W12-1 – Double Arrow</li> <li>• W16-5P,6P,7P – Pointing Arrow Plaques</li> <li>• W20-7 – Flagger</li> <li>• W21-1 – Worker</li> </ul>	
Fine Symbol Signs (symbol signs not listed as bold symbol signs)					
Special Cases					
<ul style="list-style-type: none"> <li>• W3-1 – Stop Ahead: Red retroreflectivity ≥ 7</li> <li>• W3-2 – Yield Ahead: Red retroreflectivity ≥ 7; White retroreflectivity ≥ 35</li> <li>• W3-3 – Signal Ahead: Red retroreflectivity ≥ 7; Green retroreflectivity ≥ 7</li> <li>• W3-5 – Speed Reduction: White retroreflectivity ≥ 50</li> <li>• For non-diamond shaped signs, such as W14-3 (No Passing Zone), W4-4P (Cross Traffic Does Not Stop), or W13-1P,2,3,6,7 (Speed Advisory Plaques), use the largest sign dimension to determine the proper minimum retroreflectivity level.</li> </ul>					

**NOTE:** Type I and II materials both have a uniform appearance similar to metallic paint, whereas all Type III, IV, VII, VIII, IX and X materials have a pattern of hexagons, diamonds or circular shapes measuring about one-eighth inch across. Therefore, it is easy to recognize the inferior Type I and Type II materials. FHWA’s Retroreflective Sheeting Identification Guide – 2011(available at [http://safety.fhwa.dot.gov/roadway\\_dept/night\\_visib/sign\\_visib/sheetguide/](http://safety.fhwa.dot.gov/roadway_dept/night_visib/sign_visib/sheetguide/)) is a handy tool to help determine the grade and manufacturer of most sheeting materials.

**Enhanced Conspicuity for Signs**

There are situations where engineering judgment determines the need for increased conspicuity of regulatory, warning or guide signs. This can be accomplished through increasing the size of the sign,

doubling-up by placing a second identical sign on the left side of the highway or adding a conspicuity device to the sign. The most frequent conspicuity device is an 18" square panel made with fluorescent orange material and turned 45 degrees for mounting above the sign. The Conspicuity Plaque (W16-102P) may be ordered using material #327903

### **Recouping Costs Incurred from Crashes**

Sign maintenance is frequently required because of highway crashes. Therefore, if the responsibility party is identified, record the vehicle information and provide it to the Damage Recovery Unit in the Bureau of Maintenance and Operations so that the Department can receive reimbursement from the individual or their insurance carrier, in accordance with Publication 23, Chapter 14.

If a logo sign is damaged, the Department should contact the Pennsylvania Tourism Signing Trust.

### **Laws, Regulations, and Other Publications**

Adopt-A-Highway Operational Manual. A PennDOT manual defining the procedures and types of signs available for the Adopt-A-Highway Program.

Approved Construction Materials – Bulletin 15 (Publication 35). A listing of approved materials and manufacturers, including sign materials and sign manufacturers.

Maintenance Manual (Publication 23). A manual prescribing the planning, scheduling, equipment, materials, and labor required to accomplish the Department's highway maintenance program.

Manual on Uniform Traffic Control Devices (MUTCD). A manual adopted by the Federal Highway Administration, and which establishes national guidelines for traffic-control devices, including signs. Specifically, Part 2 addresses traffic signs, and is available at <http://mutcd.fhwa.dot.gov/index.htm>.

Official Traffic Signs (Publication 236). A compilation of official traffic signs approved either by regulation or by signature of the Secretary or designee. The standards include the justification for the signs and the design details necessary to fabricate the signs.

A Policy on Geometric Design of Highways and Streets. The universal standard for geometric design of highways and streets, as published by the American Association of State Transportation Officials (AASHTO). This manual is also commonly called the "Green Book."

Sign Foreman's Manual (Publication 108). The Sign Foreman's Manual depicts the various responsibilities of the sign foreman.

Specifications (Publication 408). Specifications referenced for all Department construction projects, which includes requirements for the installation of signs and sign accessories.

Standard Highway Signs and Markings (SHS) book. FHWA's compilation of sign designs approved for national use, which is also the basis for designing the signs in Publication 236. In addition to sign designs, the book includes recreational or cultural interest symbols.

Traffic Control – Pavement Marking and Signing Standards (Publication 111). Standard drawings specifying the types, dimensions, locations and lighting of signs on expressways and freeways, and the legend spacing and sign supports for signs on all highways. Also includes details for pavement markings, snowplowable raised pavement markers, delineation, and Type III barricades.



## 2.2 Official Signs and Approved Sign Manufacturers

### Official Signs

The following signs are “official signs” and may be installed in highway rights-of-way within the Commonwealth:

- Signs included in the Handbook of Approved Signs (Publication 236).
- Signs included in the Traffic Control Signing Standards (Publication 111).

Signs that were approved at the time of their manufacture but are no longer listed in the above referenced publications may continue to be used until they fulfill their useful life unless directed otherwise.

### Approved Sign Manufacturers

- a) Types of Manufacturers. The following sign manufacturers are approved to make official traffic signs:
- PennDOT’s Sign Shop, located at 21st and Herr Streets, Harrisburg.
  - Department of Conservation of Natural Resources (DCNR) Sign Shop.
  - Department-approved commercial sign manufacturers listed in Publication 35 or other lists made available from the Department.

Department-approved municipal sign manufacturers. A list is available from the Department.

- b) Sign Identification. The manufacturer may apply their name or logo on the face of the sign. Manufacturers other than the Department’s Sign Shop shall identify their Department approval number and may include their name on the front or back of each sign manufactured for use along a public highway within the Commonwealth in accordance with the following:

Sign identifications on the front of the sign shall be confined to either a 1-inch diameter circle on the lower edge of the sign on or near the sign border, or within a 0.5-inch by 2-inch rectangle on or near the border on the lower half of the sign. The identification may be screened on the sign or durably affixed by a transparent sticker.

Sign identification on the back of the sign shall be on the lower half of the sign, positioned at a location that will not be covered by a sign post.

## 2.3 Approval and Erection Responsibilities

### Signing Responsibilities

Effective sign maintenance is important from a customer satisfaction perspective, and from a safety aspect in reducing crashes. Therefore, careful management of sign maintenance at all levels throughout the Department is essential.

Altogether many organizations within the Department are involved in signing and each has their necessary function and area of responsibility. The flow line of information and direction starts with Department regulations and policies and ends with the actual installation and maintenance of the signs.

a) Traffic Engineering Division (TED)

- Central Office. TED's staff in the Central Office is responsible for the following: establish signing policies and guidelines; develop standards, specifications, and regulations related to signing; develop annual contracts for the purchase of miscellaneous signs, sign accessories and work zone traffic-control devices for use by the county, maintenance districts, and raw materials for use by the Sign Shop; assist in development and implementation of sign-related safety programs; monitor the statewide use and inventory of signs and sign accessories; perform quality assurance reviews of sign installations; and oversee the sign inventory component of our SAP Plant Maintenance system.
- Sign Shop. The Sign Shop manufactures signs, and stocks select signs and sign accessories for distribution to the county maintenance districts. The Sign Shop's general goal is to have all signs which are manufactured or stockpiled at the Sign Shop and all sign accessories available for pickup by the counties within 2 weeks after receipt of the orders. On request, the Sign Shop will fill any priority order as soon as their schedule permits.

b) Engineering District.

- District Bridge Unit. Captures signs associated with bridges and coordinates with the District Traffic Unit when changes are necessary. This is to include noting when changes are needed for the Plant Maintenance sign inventory database.
- District Traffic Unit. The District Traffic Unit determines what signs and delineation devices should be in place along all State highways within the Engineering District. They also prepare a notification of changes, e.g., install of new signs or the relocation or removal of existing signs, via SAP Plant Maintenance. The Traffic Unit may design custom-made signs for inclusion with SAP Plant Maintenance sign orders and take retroreflective readings of select signs for recording in SAP Plant Maintenance. The District Traffic Unit prepares maintenance customer service records related to signing and when required, assigns priorities or due dates for signing work. They provide technical assistance and guidance to the Maintenance Districts in matters related to signing. Ensure that 20 percent of all signs in the Engineering District are reviewed annually.

It is the responsibility of the District Traffic Unit to ensure Department compliance with the Expected Sign Life Method (more information can be found at the FHWA website, ([http://safety.fhwa.dot.gov/roadway\\_dept/night\\_visib/retrotoolkit/index.htm](http://safety.fhwa.dot.gov/roadway_dept/night_visib/retrotoolkit/index.htm))). In this method, individual signs are replaced before they reach the end of their expected service life. The expected service life is based on the time required for the retroreflective material to degrade to the minimum retroreflectivity levels.

The listing of signs will be provided to the County Maintenance districts.

- District Plant Maintenance Coordinator. The District Plant Maintenance Coordinator trains and directs county personnel to use the computer for inventory control and sign orders; provides guidance for establishing reorder points and reorder quantities; validates and upgrades county input data to insure accurate records; and supervises the scheduling and reporting of periodic physical inventory checks.
- District Maintenance Unit. The District Maintenance Unit prepares contracts and lease arrangements for equipment not owned by the Department. Some of this equipment, such as cranes, bucket trucks and auger trucks, may be useful for signing projects.

- District Permit Unit. Ensure that the District Traffic Unit is aware of all signs required as part of any permit.
- c) County Maintenance District Responsibilities.
- Administrative Staff.
    - Identify traffic-control devices that are damaged or in need of repair.
    - Conduct routine reviews of signs.
    - Prepare maintenance customer service records for the routine maintenance of existing signs.
    - Establish a work schedule for the sign foreman and create SAP Plant Maintenance work orders.
    - Ensure that the issued work orders are completed in a timely and satisfactory fashion.
    - Transport signing materials from the Sign Shop to the County.
    - Provide direction to the sign foreman and other maintenance foremen for handling minor items on signing such as replacement of missing bolts on signs.
    - Inspect work performed by the sign crew.
  - Storekeeper.
    - Maintain storage location "0001" with signs and sign accessories for the routine maintenance and replacement of signs.
    - Place sign accessory material orders via SAP Plant Maintenance.
    - Receive into inventory signs and accessories.
    - Recommend inventory adjustments.
    - Perform MRP runs to ensure adequate supply of on-hand sign inventories.
  - Sign Foreman.
    - Complete sign work orders issued by the Assistance County Maintenance Manager.
    - Maintain existing signs and delineation devices in a systematic manner, including trimming trees and bushes to provide visibility to the traffic-control devices.
    - Inform the storekeeper or other responsible persons of existing and anticipated material needs.
    - Complete M-206 Customer Service Record Forms.

Therefore, Sign maintenance responsibilities are as follows:

1. County personnel (ACMM and Sign Foreman) are now responsible for identifying worn-out and vandalized signs. The District Traffic Unit will assist to ensure 20 percent of signs are reviewed annually. The County should conduct a systematic review with other work functions.

The District Traffic Unit is responsible for performing all engineering studies required to identify new or revised signing needs.

2. Ordering signs used on a routine basis is performed by the County, so that the County inventory can be controlled. The District Traffic Unit will be involved in CAD drawing development for sign fabrication and special signs.
3. If a District/County is in need of a sign(s) on a priority basis, the county can call the Sign Shop manager (717-346-9910) and arrange to have the signs made quickly. Districts and counties should use this service on rare occasions when unexpected and unanticipated events occur.
4. A sign inventory record system of field placements is a useful tool in evaluating and managing signs. The inventory record is necessary so that the Sign Foremen and ACMM can readily detect missing signs and serves as an important management tool for the overall sign program. Therefore, it is essential to maintain the inventory in SAP Plant Maintenance following the detailed process developed in the Plant Maintenance role procedures. This is essential for the Sign Life Maintenance program.
5. Customer surveys indicate that visible and retroreflective highway signage is an important service. County managers are strongly encouraged to dedicate sign crews to sign upgrades and minimize the time the sign crew is used for other work functions, including placement of work zone control.
6. The on-hand sign inventories in the counties are to be kept to a minimum. Use signs in inventory before ordering equivalent new signs from the Sign Shop. Each county should generally have no more than a 4- to 6-week inventory of signs for replacement due to knockdowns (e.g., STOP, Curve, Speed Limit, etc. signs). A listing of recommended on-hand sign inventories is shown in [Exhibit 2-32](#) on page [2-112](#).

### Signs Erected by Others

Title 67 Pa. Code Chapter 212a identifies the signs that local authorities or others may install on State highways and on local highway approaches to State highways with and without Department approval. However, the Department may enter into an agreement with municipalities to alter their responsibilities.

Signs installed by others that require Department approval will be inventoried in SAP Plant Maintenance.

### Issuance of Sign Work Orders

Sign work orders are the responsibility of the County Maintenance District.

## 2.4 Regulatory Signs

### Requirement for Engineering and Traffic Study

The decision to use an approved traffic control device that imposes restrictions that are not normal rules of the road should be based on an engineering and traffic study. Applicable studies are included in 67 Pa. Code Chapter 212a.

### Establishment of Priorities

Signs should be used only where warranted by facts and field studies. Signs are essential where special regulations apply at specific places or at specific times only, or where hazards are not self-evident.

Regulatory signs are not necessary to confirm rules of the road.

## STOP Sign Installations

Give the installation of STOP (R1-1) signs the highest priority of all signs. When downed R1-1 signs are reported, sign crews should respond as soon as possible since the downed or missing stop sign represents a high risk for crashes. Due to this liability, when replacing a downed or missing R1-1 sign, sign crews should ensure that motorists are aware of the situation at the uncontrolled intersection by providing flagging, a temporary STOP sign on a stand, or some other appropriate traffic control measure.

If a new STOP sign is installed, a red flasher should be placed on the installation for a minimum of 30 days.

## Signing Responsibilities at Intersections with Local Roads

67 Pa. Code §212a (relating to official traffic control devices) was adopted in the Pennsylvania Bulletin. Specifically, §212.5(d) (relating to traffic-control devices on local highway approaches to intersections with State highways) establishes sign installation and maintenance responsibilities at intersections between State highways and local roadways.

### The Department Responsibilities

When a Department employee discovers a damaged or missing STOP (R1-1) or YIELD (R1-2) sign on a local roadway approach to a State highway, the employee should notify the responsible municipality. If the municipality cannot respond in a timely fashion, the county should replace the sign with a temporary or permanent installation to ensure that safety is not compromised. The county is to notify the local authorities of the action taken.

County Maintenance offices should document all communication and work associated with the replacement of the damaged or missing sign on the local road approach.

### Local Authorities Responsibilities

For Local Authority Responsibilities refer to 67 Pa. Code §212a.

## Posting Regulatory Speed Limits

### Posting of Speed Limits at Intersections

Use the following guidelines if a problem exists in the enforcement of a speed limit that ends at an intersection:

1. Ending a speed limit on the stem of a T-intersection. Since [§3362\(b\)](#) of the Vehicle Code (relating to posting of speed limit) requires that official traffic-control devices be posted at the beginning and end of each speed zone, it is necessary to install signs indicating the end of a speed limit on the stem of a T-intersection in one of two ways:
  - The preferred method is to install a Speed Limit (R2-1) sign indicating the appropriate speed limit on the other two legs within a reasonable distance beyond the intersection, e.g., within 200 feet of the intersection.
  - A less desirable method is to install an END (R3-9DP) sign over a Speed Limit (R2-1) sign in advance of the T-intersection. However, this method may be necessary if there is no speed limit on the other roadway and it has not been determined through test runs that it is safe for travel at 55 mph.
2. Ending the speed limit at a four-way intersection. If a posted speed limit does not exist along the highway beyond the intersection and it has not been determined through test runs that the

following section of highway is safe for travel at 55 mph, Districts may end the speed limit by installing an END (R3-9DP) sign above a Speed Limit (R2-1) sign in advance of the intersection.

3. If the highway beyond the intersection and the intersecting highway have posted speed limits or are safe for travel at 55 mph, Speed Limit (R2-1) signs indicating the speed limit along the three other legs of the intersection may be installed within a reasonable distance from the intersection, e.g., within 200 feet of the intersection.
4. Speed limit for turning vehicles at intersections. Neither the Vehicle Code nor regulations require that drivers turning from one highway onto another highway be advised of the speed limit along the highway they are entering. Therefore, it is possible that a turning driver could travel up to one-half mile before knowing what the speed limit is along the highway they have entered.
5. Normally, this is not a problem if the speed limit along the entered highway is higher than the speed limit along the highway the driver is leaving. However, this can create a possible “speed entrapment” condition if a lower speed limit exists along the second highway. In view of this, Districts should consider the installation of Speed Limit (R2-1) signs within a reasonable distance from intersections if the following conditions exist:
  - The speed limit along the second highway is lower than the speed limit along the first highway.
  - The normal one-half mile spacing of speed limit signs has not provided a sign within a reasonable distance from the intersection, e.g., within 500 to 1,000 feet of the intersection.
  - There is a high number of turning, non-local vehicles.

#### **Posting of Regulatory Speed Limits and Advisory Speeds**

When the speed on an Advisory Speed (W13-1P) plaque is lower than a posted regulatory speed limit, give priority to the installation of the warning signs with advisory speeds. For example:

1. Do not install a R2-1 sign within the area covered by the W13-1P plaque, or within a distance in feet in advance of the warning sign equal to 10 times the regulatory speed limit in miles per hour (e.g., 550 feet for a 55-mph speed limit).
2. An R2-1 sign may be installed immediately following the section of roadway covered by the warning signs (e.g., within 200 feet after the end of a curve).

Since this posting of signs may result in distances between R2-1 signs that are greater than one-half mile apart, it may be possible to install a supplemental R2-1 sign at an intermediate location. In any event, it is more in the interest of motorists’ safety to tell drivers the safe speed than to possibly confuse them by installing conflicting regulatory and advisory signs.

#### **Posting of Regulatory Speed Limits and School Speed Limits**

Whenever possible, do not install conflicting Speed Limit (R2-1) signs within a 15-mph school zone speed limit, or within a distance of 10 times the speed limit, in feet, of the beginning of the school speed limit.

#### **PASS WITH CARE Signs**

PASS WITH CARE (R4-2) signs must be installed at the end of no-passing zones to comply with the requirement to post the end of each no passing zone.

## ONE-WAY Sign Installations

Property owners are initially responsible for installing and maintaining ONE-WAY (R6-1, R6-2) signs to notify motorists that they are exiting a non-residential driveway onto a one-way highway. This responsibility (in the case of driveways) is uniform for new and long existing one-way highways and driveways as well as for permitted and non-permitted driveways. If a problem is identified, the owner should be contacted and the responsibility documented through a Highway Occupancy Permit or Supplemental Permit, recorded in the County Office of the Recorder of Deeds.

The Office of Chief Counsel advises that despite the permittee's responsibility in the first instance to install the sign, the Department may still have the ultimate responsibility, in the face of possible tort liability, to assure the safety of the traveling public if the permittee fails to erect a sign following a Department directive.

For example, if the absence of a ONE-WAY sign at a business driveway is a "dangerous condition," then the Department would be obligated to take corrective action. If the property owner does not take any action following a proper notification on our part, the District should install the sign and bill the permittee to recover its costs.

## Weight Limits

### Advance Signs

§4902(e) of the Vehicle Code (relating to erection of signs) requires the erection of restriction signs within 25 feet of each end of a bridge or portion of highway with a weight restriction. Moreover, when the restriction does not begin or end at an intersection with an unrestricted highway, signs are also required at the intersection nearest each end of the restricted bridge or portion of highway to avoid entrapment.

If multi-restrictions exist along a highway between intersections with unrestricted highways (e.g., various bridge weight limits), it is necessary to install advance signing for each restriction unless the first restriction is the most limiting. This signing is required regardless of whether the unrestricted intersecting highway is a State highway or a local roadway or whether the roadway would afford the driver the best alternate route around the restriction. If the closest unrestricted intersecting highway will not provide a suitable alternate route around the restriction, consider an installation of additional advance informational signs at the last intersecting highway that will provide a suitable alternate route.

### Prompt Posting of Bridge Weight Limits

When approved, it is extremely important to promptly post all bridge weight limits. To expedite the posting, each county should maintain an inventory of the commonly used R12-1, W16-103P, and R12-5A signs (see the section [County Sign Inventory](#) on page [2-109](#)).

In lieu of stocking only completely finished signs, the county may elect to stock some partially finished signs (i.e., without the numerals), and to stock some cutout pressure-sensitive numerals. The numerals should consist of 5" E-Series digits for the standard size R12-1 and R12-1-1 signs and 3" E-Series digits for the standard size R12-5A signs.

On request, the Sign Shop will supply packs of five numerals of the same type as a single commodity. Since cutout pressure-sensitive legend has a tendency to dry out; therefore, counties should stock no more than a normal 12-month supply. Store legend upside down to help prevent curling, and use the oldest legend first.

Counties should apply pressure-sensitive legend at the location illustrated in the official sign standard, using the procedure outlined in [Exhibit 2-5](#).

### Signing on Lower-Volume Roads

Part 5 of the *MUTCD* is entitled, “Traffic Control Devices for Low-Volume Roads.” However, in accordance with Paragraph B in Section 5A.01 of the *MUTCD*, the definition of “low-volume road” excludes all state highways.

Although Part 5 of the *MUTCD* is not applicable to this manual, it is still permissible to modify signing practices on lower-volume State highways. For example, since these roads typically have mostly local traffic, directional and guide signs are generally not required.

Moreover, because of the lower traffic volumes, there are typically fewer crashes on these roads even though the vertical and horizontal alignment may be worse than the higher-volume roads. Therefore, use engineering judgment to determine the recommended number and types of regulatory and warning signs. Alternate methods to provide adequate signing are as follows:

1. No posted regulatory speed limit, but all significant curves and turns identified by warning signs with advisory speeds plaques when appropriate.
2. A reduced regulatory speed limit with fewer curve and turn signs.
3. No posted regulatory speed limit, but WINDING ROAD NEXT (\_\_\_) MILES (W1-5-1) sign or NARROW ROAD NEXT (\_\_\_) MILES (W5-1-1) sign with advisory speed plaques as appropriate after all intersections.



**Exhibit 2-5 "Field" Application of Pressure-Sensitive Legend**

1. Store legend at room temperature.
2. Apply legend at the storeroom since it is difficult to apply during hot, cold or humid conditions.
3. Wash hands and the sign face with clean soapy water and thoroughly dry to insure good adhesion of the legend.
4. Use a china pencil, soft lead pencil or non-permanent felt-tip pen to draw horizontal lines on the sign face to delineate the top and the bottom of the legend in accordance with the dimensions on the approved sign standard. These lines will also be valuable to help align the legend. (Vertical lines may also be valuable in orienting some legend.)
5. Without removing the backing paper, position the characters at their relative locations. Space between characters should generally be about 125 percent of the stroke width (the width of the lines in the legend) – a slightly smaller space should be used before and after a “4” or a “7”. Characters which have a curve at the top should extend slightly above the top transverse line and characters which have a curve at the bottom should extend slightly below the lower transverse line.
6. Pull the backing paper off part of the character and align that part before removing the balance of the paper. It is best to start with the bottom of characters with straight bottoms (e.g., 2’s, A’s, L’s, etc.), and the top of characters with straight tops (e.g., 5’s, 7’s, F’s, etc.). After the first part of the character is in place, remove the balance of the paper and allow the character to flow into place without stretching the characters.
7. Use your fingernails or a special plastic blade as a squeegee to apply pressure to the characters to affix them to the sign. The legend will normally be removable for a short time by using a blade or knife to lift a corner, but if removed, apply new legend instead of trying to reapply the same legend.
8. Use a damp cloth to remove felt-tip or china pencil markings. Do not erase lead pencil markings.
9. Take pride in your work – the Department’s image is judged by it!

## 2.5 Warning Signs

### General

Guidelines for installing warning signs are included in Sections 2C of the *MUTCD*.

Consider the installation of oversize warning signs if one or more of the following exists:

- a) The condition is properly signed and/or delineated, but crashes or incidents related to the condition addressed by the warning sign continue to occur.
- b) Inadequate contrast exists between the sign and the environment when a standard size sign is used.
- c) The location is on a high-speed (45 mph or higher) highway with four or more lanes.

### Advance Placement of Warning Signs

Since the primary purpose of warning signs is to gain attention of the unfamiliar motorist, the placement of warning signs is important. The placement must allow these drivers sufficient time to see the warning sign, understand the intent, identify the potential hazard, decide what action must be taken, and then to perform any necessary maneuver.

Table 2C-4 in the *MUTCD* (see [Exhibit 2-6](#)) provides the recommended advance sign placement distances. However, it is important to note that Condition A is only for those situations where motorists may have to change lanes in heavy traffic. Examples of applicable signs include:

- Merge (W4-1).
- Pavement Width Transition (W4-2L, W4-2R).
- Entering Roadway Merge (W4-5).
- RIGHT LANE ENDS (W9-1R).

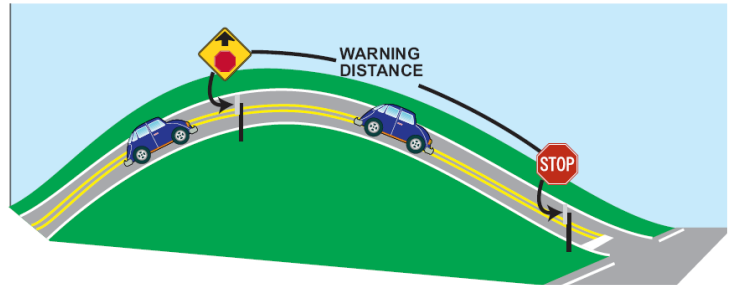

Condition B is for all other advance placement distances and these values are typically much smaller than the values historically used by traffic engineers. The reason for the change is that FHWA has reconciled their advance distances to match the stopping sight distances in Table 3-1 of AASHTO’s A Policy on Geometric Design of Highways and Streets, using a 2.5-second reaction time and a deceleration rate of 10 feet/second<sup>2</sup>. Moreover, Engineering Districts should keep in mind that these are minimum distances and they may want to use larger values for the following reasons:

- The advance distances assume that drivers will always use their brakes to decelerate to a posted advisory speed, thereby wasting energy.
- The lower advance posting distances may violate drivers’ expectations, especially if at the same time more realistic advisory speeds are used as suggested in the section [Advisory Speed Signs](#) on page 2-17.

Also, Districts should base the minimum advance distance on the “0 mph” advisory speed for the Stop Ahead, Yield Ahead, Signal Ahead, Advance Railroad Crossing, and Intersection Warning signs because a driver may wish to turn at an intersection or may need to stop due to other turning traffic.

A few warning signs are not placed in advance of the situation, but instead rely on the visibility of the sign from a distance. Examples include:

- Chevron Alignment (W1-8) sign.
- NO PASSING ZONE (W14-3) pennant.
- Pedestrian Crossing (W11-2) and School Advance Warning (S1-1) signs, when physically placed at the crosswalks with a Diagonal Arrow (W16-7p) sign.
- Double Arrow (W12-1) sign, i.e., as used on the approach end of an island where traffic can pass on both sides.

**Exhibit 2-6 Guidelines for Advance Placement of Warning Signs**

Posted or 85th-Percentile Speed	Advance Placement Distance <sup>1</sup>								
	Condition A: Speed reduction and lane changing in heavy traffic <sup>2</sup>	Condition B: Deceleration to the listed advisory speed (mph) for the condition							
		0 <sup>3</sup>	10 <sup>4</sup>	20 <sup>4</sup>	30 <sup>4</sup>	40 <sup>4</sup>	50 <sup>4</sup>	60 <sup>4</sup>	70 <sup>4</sup>
20 mph	225 ft	100 ft <sup>6</sup>	N/A <sup>5</sup>	—	—	—	—	—	—
25 mph	325 ft	100 ft <sup>6</sup>	N/A <sup>5</sup>	N/A <sup>5</sup>	—	—	—	—	—
30 mph	460 ft	100 ft <sup>6</sup>	N/A <sup>5</sup>	N/A <sup>5</sup>	—	—	—	—	—
35 mph	565 ft	100 ft <sup>6</sup>	N/A <sup>5</sup>	N/A <sup>5</sup>	N/A <sup>5</sup>	—	—	—	—
40 mph	670 ft	125 ft	100 ft <sup>6</sup>	100 ft <sup>6</sup>	N/A <sup>5</sup>	—	—	—	—
45 mph	775 ft	175 ft	125 ft	100 ft <sup>6</sup>	100 ft <sup>6</sup>	N/A <sup>5</sup>	—	—	—
50 mph	885 ft	250 ft	200 ft	175 ft	125 ft	100 ft <sup>6</sup>	—	—	—
55 mph	990 ft	325 ft	275 ft	225 ft	200 ft	125 ft	N/A <sup>5</sup>	—	—
60 mph	1,100 ft	400 ft	350 ft	325 ft	275 ft	200 ft	100 ft <sup>6</sup>	—	—
65 mph	1,200 ft	475 ft	450 ft	400 ft	350 ft	275 ft	200 ft	100 ft <sup>6</sup>	—
70 mph	1,250 ft	550 ft	525 ft	500 ft	450 ft	375 ft	275 ft	150 ft	—
75 mph	1,350 ft	650 ft	625 ft	600 ft	550 ft	475 ft	375 ft	250 ft	100 ft <sup>6</sup>

<sup>1</sup> The distances are adjusted for a sign legibility distance of 180 feet for Condition A. The distances for Condition B have been adjusted for a sign legibility distance of 250 feet, which is appropriate for an alignment warning symbol sign. For Conditions A and B, warning signs with less than 6-inch legend or more than four words, a minimum of 100 feet should be added to the advance placement distance to provide adequate legibility of the warning sign.

<sup>2</sup> Typical conditions are locations where the road user must use extra time to adjust speed and change lanes in heavy traffic because of a complex driving situation. Typical signs are Merge and Right Lane Ends. The distances are determined by providing the driver a PRT of 14.0 to 14.5 seconds for vehicle maneuvers (2005 AASHTO Policy, Exhibit 3-3, Decision Sight Distance, Avoidance Maneuver E) minus the legibility distance of 180 feet for the appropriate sign.

<sup>3</sup> Typical condition is the warning of a potential stop situation. Typical signs are Stop Ahead, Yield Ahead, Signal Ahead, and Intersection Warning signs. The distances are based on the 2005 AASHTO Policy, Exhibit 3-1, Stopping Sight Distance, providing a PRT of 2.5 seconds, a deceleration rate of 11.2 feet/second<sup>2</sup>, minus the sign legibility distance of 180 feet.

<sup>4</sup> Typical conditions are locations where the road user must decrease speed to maneuver through the warned condition. Typical signs are Turn, Curve, Reverse Turn, or Reverse Curve. The distance is determined by providing a 2.5 second PRT, a vehicle deceleration rate of 10 feet/second<sup>2</sup>, minus the sign legibility distance of 250 feet.

<sup>5</sup> No suggested distances are provided for these speeds, as the placement location is dependent on site conditions and other signing. An alignment warning sign may be placed anywhere from the point of curvature up to 100 feet in advance of the curve. However, the alignment warning sign should be installed in advance of the curve and at least 100 feet from any other signs.

<sup>6</sup> The minimum advance placement distance is listed as 100 feet to provide adequate spacing between signs.

**Signing Curves and Turns**

**Curve and Turn Signs**

The legal speed limit of the highway should be used when evaluating the need for advance Turn (W1-1) or Curve (W1-2) signs. All curves and turns with a recommended safe speed less than the legal speed for the highway should normally be signed with an appropriate curve or turn sign. An exception to the installation of a curve or turn sign may be a ramp to or from a freeway or expressway where an advisory exit speed or ramp speed sign exists and flexible delineator posts or Chevron Alignment (W1-8) signs exist.

Curve or turn signs should normally be installed a minimum distance in advance of the curve or turn equal to the appropriate values in Condition B in [Exhibit 2-6](#). To use this table, you need to know the legal or 85th percentile speed, plus the recommended advisory speed around the curve or turn.

**Advisory Speed Signs**

An Advisory Speed (W13-1P) plaque shall be installed below a Curve or Turn sign if the recommended safe speed for the curve or turn is less than the legal speed for the highway.

The safe speed on curves may be determined by making several trial runs through the curve in a car equipped with a ball-bank indicator in accordance with the following guidelines:

- a) Mount the ball-bank indicator transversely in the car at an orientation to give a "zero reading" when the car is level.
- b) For the first trial run, drive the car in the center of the lane at a speed that is a multiple of 5 mph that provides a maximum ball-bank indicator reading less than the appropriate value in [Exhibit 2-7](#).
- c) If necessary, make succeeding observations at higher 5 mph increments until the reading on the ball-bank indicator equals or exceeds the appropriate value in [Exhibit 2-7](#). The safe speed on the curve is the highest speed that does not exceed the appropriate value in [Exhibit 2-7](#) while consistently driving in the center of the travel lane.
- d) On two-way roadways, conduct test runs in each direction of travel since the safe speed may be different for the different directions of travel.
- e) When the advisory speed is less than the posted speed. If the difference between the advisory and the posted speed limit is 15 mph or greater, then a large single arrow W1-6 and/or chevron sign W1-8 must be installed.

**Exhibit 2-7 Maximum Ball-Bank Indicator Readings**

Speed (mph)	Ball-Bank Indicator (degrees)
20 or less	16
25 and 30	14
35 or more	12

**Additional Signing and Delineation at Curves and Turns**

In addition to the advance Curve or Turn sign discussed in the Section [Curve and Turn Signs](#) on page [2-17](#) and the section [Advisory Speed Signs](#) on page [2-17](#), additional signing and/or delineation of curves and turns should be considered if one or more of the following exists:

- a) Crash lists indicate that there are "run-off-the road," "hit-fixed-object," or other curve-related crashes.
- b) There is physical evidence of errant vehicles leaving the road in the form of shoulder rutting, guide rail damage, scars on adjacent trees, or other markings on the shoulder that appear to be made by vehicles.
- c) The curve or turn is "hidden" from drivers and the roadway alignment is not evident such as a combination horizontal and an over-vertical curve, an overhead utility line that diverges from the highway, or other features that could mislead drivers.
- d) Day or night test drives of the highway indicate that additional signing and/or delineation is required to adequately indicate the travel path for drivers.

The additional signing and/or delineation could consist of the Large Single Arrow (W1-6) sign, Chevron Alignment (W1-8) sign, or Flexible Delineator Posts. These devices also provide day and night target value, especially the Large Single Arrow and the Chevron Alignment signs. However, these devices should not generally be installed at a curve or turn unless an advance Curve or Turn sign exists. Exceptions are:

1. On a ramp where an Advisory Exit Speed (W13-2) or Ramp Speed (W13-3) sign exists.
2. On a ramp, freeway, or expressway where delineators are required in accordance with the Traffic Control - Pavement Markings and Signing Standards TC-8600 and TC-8700 Series (Publication 111) and the *MUTCD*.
3. At locations identified in Paragraph (1) above, but the recommended safe speed for the curve or turn as determined by ball-bank readings is equal to or higher than the legal speed limit for the highway.

If it is determined that the installation of one or more of these devices is desirable, consider the following guidelines:

- A. Large Single Arrow (W1-6) Sign. This sign should be considered for use on curves and turns that are relatively short in length. Normally curves and turns up to about 300 or 350 feet in length can be satisfactorily signed with one W1-6 sign in each direction. It is also possible to sign longer curves with a single W1-6 sign, but engineering judgment based on field conditions must be used in making this decision.
- B. You may also consider the W1-6 sign for use on compound curves, reverse curves and turns, winding roads, and other locations where a severe change in alignment occurs.
- C. Chevron Alignment (W1-8) Sign. Based on the results of a study in Virginia, "Evaluation of Curve Delineation Signs," published in Transportation Research Record 1010, consider this sign for curves or turns that are greater than 7 degrees. In addition, consider the W1-8 sign when:
  - Standard delineation is in place, but there is still a high incidence of daytime and/or nighttime "run-off-the-road" crashes.
  - Standard delineation does not, or would not, show the roadway alignment; e.g., combination horizontal and over vertical curve.

Do not use the W1-8 sign if a turn has inadequate length for proper spacing of the W1-8 sign.

When used, a minimum of two signs should always be visible. Do not install the first W1-8 sign before the P.C. and the last sign beyond the P.T. When applicable, W1-8 signs may be installed on back-to-back installations as described in the Sign Foreman's Manual (Publication 108).

When W1-8 signs are used, [Exhibit 2-8](#) shows recommended spacing based on three different methods in accordance with TTI Report FHWA/TX 04/0 4052 1, entitled *Simplifying Delineator and Chevron Applications for Horizontal Curves*.

**Exhibit 2-8 Suggested Spacing for W1-8 Signs**

Method 1	Method 2	Method 3	Chevron Spacing (feet)
Curve Radius (feet)	Degree-of-Curve*	Curve Advisory Speed (mph)*	
< 200	> 28.6	≤ 15	40
200 - 400	14.3 - 28.6	20 - 30	80
401 - 700	8.2 – 14.2	35 - 45	120
701 – 1250	4.6 – 8.1	50 - 60	160
> 1250	< 4.6	> 60	200

\* “Degree-of-Curve” (D) is the measurement, in degrees, of the change in alignment over a 100-foot section of roadway. The degree-of-curve can be calculated by the formula  $D=5729.6/\text{radius}$ .

- A. Flexible Delineator Posts. Based on the results of the study in Virginia, these devices should be considered for use on curves that are less than or equal to 7 degrees. They may be considered for use on curves or turns which are greater than 7 degrees, when it has been determined that the W1-8 sign should not be used.
- B. Combination of Signs and/or Delineation Devices. A combination of devices discussed above may be used to delineate a curve or turn (or combination of curves or turns), if a field review indicates the need for a combination of devices to adequately advise drivers of the roadway alignment.

**Degree-of-Curve**

If you do not know the degree-of-curve or the radius of a curve, you can estimate the degree-of-curve by two methods. First, you can take the total change in direction of the curve and divide by the length of the curve in hundreds of feet to calculate the degree-of-curve. For example, if you have a right angle (90 degree) curve that measures 1,000 feet from the beginning of the curve (P.C.) to the end of the curve (P.T.), the curve would be a 9-degree curve (i.e.,  $90/10 = 9$ ). A compass that includes degrees and a distance-measuring instrument (DMI) are of value.

Although labor intensive, the second method involves stretching a 62-foot string between two points along the roadway’s centerline or an edge line, and measuring the distance from the center of the string to the line. This distance is the middle ordinate, and when measured in inches, it very closely approximates the “degree-of-curve” for curves with a degree-of-curve up to approximately a 45-degree curve (e.g., a 10-inch middle ordinate equals a 10-degree curve, a 20-inch middle ordinate equals a 20-degree curve, etc.).

[Exhibit 2-9](#) illustrates this method.

Other methods are available in other text book references if desired.

**Exhibit 2-9 Estimating the Degree of Curve**

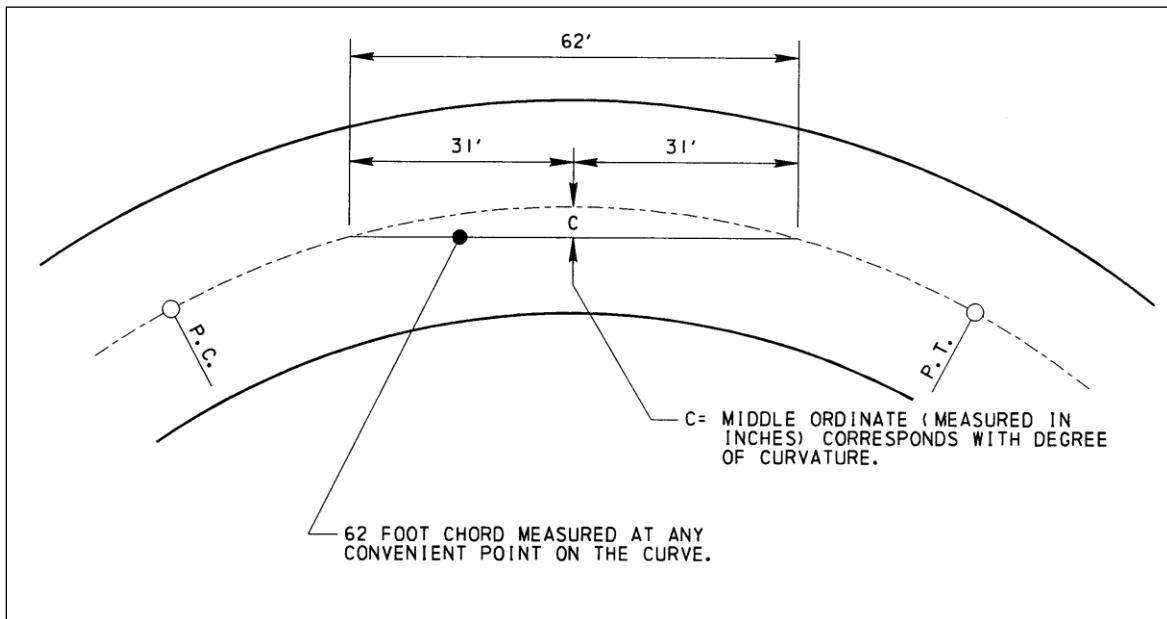

**Stop Ahead Signs**

Stop Ahead (W3-1) signs should be installed in advance of STOP (R1-1) signs when one or more of the following exists:

- a) Because of physical conditions, the R1-1 sign is not continuously visible for the required distance specified for the W3-1 sign in Publication 236.
- b) Although the R1-1 sign is visible for the minimum distance in Publication 236, one of the following exists:
  - o A “running-the-stop-sign” crash experience exists.
  - o The view of the R1-1 sign is occasionally blocked by moving or stopped vehicles.
  - o The highway has a multi-lane, high-speed (45 mph or higher) approach to the R1-1 sign. (Note, if a divided highway and the median is wide enough, the STOP Sign and/or the Stop Ahead Signs should be installed on both sides of the roadway.)
  - o There is extensive environmental interference.

When used, install the Stop Ahead (W3-1) sign in advance of the R1-1 sign in accordance with the distance indicated in Condition B in [Exhibit 2-6](#).

**Share the Road Sign**

The Share-the-Road Sign (W16-101) is available for installation on appropriate State highways throughout the Commonwealth. The purpose of the sign is to promote cooperation, understanding, and mutual safety between motorists and bicyclists on roadways where sharing roadway space is required.

Requests for the W16-101 sign may come from any legitimate source, including the following internal or external sources:

- a) Department designers or consultants may independently suggest the installation of the signs as part of the project development process. In addition, Department personnel may suggest locations for the signs as a stand-alone project.
- b) Non-department personnel may suggest locations for installation without solicitation from the Department. These suggestions may be included as part of a larger project or as a stand-alone project. Forums for this input may be District Bicycle/Pedestrian Advisory Committees, MPO/LDD Bicycle/Pedestrian Advisory Committees, or other sources. However, it is important to note that the Department will not provide signs to local municipalities for installation on local roads.

All requests for W16-101 signs on State highways should go to the District Bicycle/Pedestrian Coordinator for review. The criteria for road selection should include roads that possess any or all of the following:

- Highways promoted as a cycling route by a local or state agency, or that demonstrate a need based on the traveling patterns of local cyclists or a car-bike crash history.
- Prior to bottlenecks such as narrow bridges or underpasses, and short stretches of roads that lack paved shoulders.
- On sections of highway that have numerous commercial driveways, such as in a cluster of suburban strip malls.
- Sections of highway where lanes are greater than 14 feet wide and motorists may be tempted to travel two abreast and crowd cyclists off the road.
- On narrow highways where cyclists can only proceed safely if, they use the full lane width.

If the Bicycle/Pedestrian Coordinator determines that a request is justified, counties may order W16-101 signs from the Sign Shop. If installed by the Department, the Department is responsible for maintenance of the signs.

### Advance Street Name Signs

On multilane roads and roads with a speed limit greater than 35 mph, Districts are encouraged to use either the Single-Line Advance Street Name (W16-8P) or Double-Line Advance Street Name (W16-8AP) sign, with appropriate arrows, as necessary, below any of the following advance warning signs:

- Any W1-series sign with a side road.
- Cross Road (W2-1) sign.
- Offset Side Road (W2-7L, W2-7R) sign.
- Side Road (W2-2) sign.
- Double Side Road (W2-2D).
- 45° Side Road (W2-3L, W2-3R) sign.
- Curve – Side Road (W2-3-1L, W2-3-1R) sign.
- “T” Symbol (W2-4) sign.
- “Y” Symbol (W2-5) sign.
- “Y” Symbol Secondary (W2-5-1L, W2-5-1R) sign.
- Stop Ahead (W3-1) sign.
- Signal Ahead (W3-3) sign.



Note: The decision to erect the above-listed warning signs should be based on their justification in Publication 236, and not solely to facilitate the installation of Advance Street Name Signs. As an alternate, you may install the Single-Line Advance Street Name (D3-2) sign or the Double-Line Advance Street Name (D3-3) sign in lieu of the W16-8P or W16-8AP sign.

If a Double-Line Advance Street Name (W16-8AP) sign is installed below a Double Side Road (W2-8) sign, the order of destinations on the W16-8AP sign should correspond to the warning sign graphic as illustrated in [Exhibit 2-10](#). Further, the advance turn style arrow must be used for the second street encountered.

**Exhibit 2-10 Order of Destinations for Double Side Road Sign**

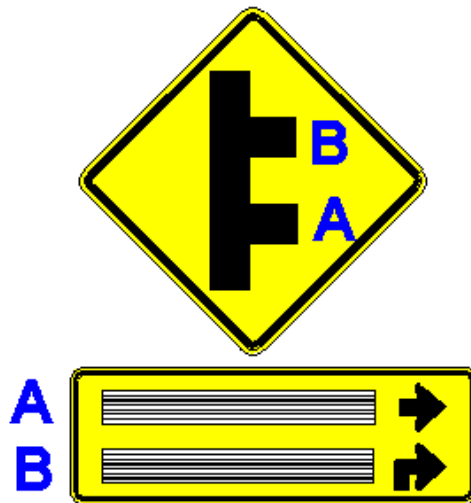

## 2.6 Guide Signs and Route Markers

### General

Guide signs are necessary to inform motorists of intersecting routes; to direct them to cities, towns, villages, or other important destinations; to identify nearby rivers, streams, parks, forests, and historical sites; and generally to give such information as will help them along their way in the most simple, direct manner possible.

Numbered traffic routes and directional signs facilitate travel by enabling motorists to reach their intended destination when using an accurate transportation map. Proper directional signing consists of Route Markers and Route Marker auxiliaries; Destination signs; Distance signs; and, where necessary, Advance Street Name signs.

Install Route Markers and Route Marker auxiliaries in sign assemblies to identify the numbered traffic route and provide additional guidance (such as general direction of the route and other information required to follow a designated numbered traffic route). Destination and Distance signs provide directions and distances to communities and points of interest that may be reached by following certain roads. Advance Street Name signs provide advance notice of the names of intersecting major streets and highways.

## Definitions

The following words and terms, when used in this policy shall have the following meanings, unless the context clearly indicates otherwise:

**Advance Route Turn Assembly** – An assembly consisting of a Cardinal Direction Marker and other Route Marker auxiliaries if needed, a Route Marker, and an Advance Turn Arrow.

**Advance Street Name Sign** – A sign used in advance of an intersection that displays the street or road names for the next cross or side road, and may contain directional arrows as appropriate. The sign may be either:

- White legend on a green background and installed either separately or as a part of other destination signs (D1 Series) sign.
- Black legend on a yellow background (W16-8P or W16-8AP sign) installed below an intersection-related warning signs as discussed in the Section **Advance Street Name Signs** on page **2-22**.

**Advance Turn Arrow** – A marker which displays a right or left arrow, the shaft of which is bent at a right angle or at a 45-degree angle. It is to be mounted below the Route Marker in Advance Route Turn Assemblies.

**BUSINESS Marker** – An M4-3 marker used to designate an alternate route that branches from a regular numbered route, passes through a business area, and rejoins the regularly numbered route beyond that area. If a Cardinal Direction Marker is used, it shall be mounted above the Business Marker.

**BY-PASS Marker** – An M4-2 marker used to designate a route that branches from the regular numbered route, bypasses a part of a city or congested area, and then rejoins the regular numbered route.

**Cardinal Direction Marker** – A marker with the legend EAST, WEST, NORTH, or SOUTH mounted above a route marker to indicate the general direction of the entire route.

**Confirming or Reassurance Assembly** – An assembly consisting of a Cardinal Direction Marker and a Route Marker which is placed along a numbered traffic route to reassure motorists that they are on their desired route.

**Control city** – These are major communities on or along a numbered traffic route that are familiar to a majority of drivers from either Pennsylvania or other states. These destinations must be shown on the Department's Official Transportation Map and should have a population of at least 10,000 or be a county seat. The control city may be in an adjacent State if there are no communities along the route in Pennsylvania that meet these minimum criteria. Control cities for Interstate highways are listed in **Exhibit 2-19**.

**Destination Sign** – A sign with the names of communities, points of interest, or street or road names with appropriate distances and directional arrows, if required. Destination signs are D1-Series signs, typically D1-1 through D1-3 signs. If distances are included, they should be to the central business district, or if none, to the center of the community.

**DETOUR Marker** – An M4-8 marker used to designate a temporary route that branches from a regular numbered route, bypasses a section of a route that is closed or blocked by construction or traffic emergency, and rejoins the regular numbered route beyond that section. When used, the Detour Marker will always be mounted at the top of the assembly.

**Directional Arrow** – A marker which displays a single-headed arrow pointing in the general direction (left, right, straight, 45 degrees left or right) that a route may be followed. The Directional Arrow should always be below the route marker in directional assemblies.

**Directional Assembly** – An assembly consisting of a Cardinal Direction Marker and other Route Marker auxiliaries if needed, a Route Marker, and a Directional Arrow.

**Distance Sign** – A sign carrying the names of not more than three communities or points of interest, and the distance (to the nearest mile) to those places. Distance signs are D2-Series signs, typically D2-1 through D2-3 signs.

**END Marker** – An M4-6 marker used to indicate that the numbered traffic route is ending. The marker should be mounted either directly above the Route Marker, or above a marker for an alternate route that is part of the designation of the route being terminated.

**Junction Assembly** – An assembly consisting of a Junction Marker and a Route Marker.

**Junction Marker** – An M2-1 or M2-1-1 marker with the abbreviated legend JCT mounted at the top of an assembly.

**Minor terminal** – Communities or nationally known points of interest, except control cities, that are served by the numbered traffic route. Minor terminals can be used to guide motorists and/or to provide supplemental information relative to the position of motorists along their intended travel route. These destinations must be shown on the Department's Official Transportation Map, and may include county seats and communities where there are junctions of major traffic routes.

**Numbered traffic route** – A highway that has been assigned an Interstate, United States, or Pennsylvania route number to aid motorists in their travels. Any changes to Interstate or United States numbered traffic routes require approval of the American Association of State Transportation Officials (AASHTO).

**Route Marker** – Markers used to identify and mark a numbered traffic route.

**Route Marker Assembly** – An assembly which consists of a Route Marker and Route Marker Auxiliaries which further identify the route and indicate direction. Assemblies for two or more routes, or for different directions on the same route, are normally mounted in groups on a common support.

**Route Marker Auxiliaries** – Supplemental signs used with Route Markers to provide additional information about the numbered traffic route. Route Marker Auxiliaries shall match the color combination of the respective marker which they supplement. Route Marker Auxiliaries include, but are not limited to, Junction Markers, Cardinal Direction Markers, BY-PASS Markers, BUSINESS Markers, TRUCK Markers, TO markers, END Markers, DETOUR Markers, Advance Turn Arrows, and Directional Arrows.

**Special Road Facility Symbol** – A route marker designating the Pennsylvania Turnpike, or any other Department-approved symbol marker designating routes.

**TO Marker** – An M4-5 or M4-5-1 marker used to provide directional guidance to a particular road facility from other highways in the vicinity. When used, it is mounted at the top of an assembly.

**Trailblazer Assembly** – An assembly consisting of a TO Marker, a Cardinal Direction Marker if needed, a Route Marker or special road facility symbol, and a single-headed directional arrow pointed along the route leading to the road. This assembly provides directional guidance to a particular road from other highways in the vicinity.

**TRUCK Marker** – An M4-4 marker used to designate an alternate route for trucks that branches from a regular numbered route, bypasses an area which is congested or where height or weight limitations have been established, and rejoins the regularly numbered route beyond that area.

## Clearview Font

The *MUTCD* defers to the *Standard Highway Signs and Markings* (SHS) book for the design of letters, numerals, route shields, and spacing. However, on September 2, 2004, FHWA issued interim approval for the optional use of the Clearview font for positive legends (i.e., white legend) on all guide signs. Research shows that the Clearview font generally improves the maximum nighttime sign legibility distance by approximately 12 percent for the same size sign. (See the interim approval at [http://mutcd.fhwa.dot.gov/pdfs/ia\\_clearview\\_font.pdf](http://mutcd.fhwa.dot.gov/pdfs/ia_clearview_font.pdf).)

In accordance with the interim approval, FHWA will grant statewide interim approval to use the Clearview font for white legend on any guide sign to any highway agency that submits an appropriate written request. The Department obtained FHWA approval to use the Clearview font for not only the Department, but also for all local authorities within the Commonwealth.

**Exhibit 2-11** shows the transition from Highway Gothic fonts, as mentioned in the *MUTCD*, to Clearview fonts.

### Exhibit 2-11 Transitioning to the Clearview Font

SHS Standard Alphabet	Clearview "W" Series	Typical Abbreviation
Series B	Clearview 1-W	CV 1W
Series C	Clearview 2-W	CV 2W
Series D	Clearview 3-W	CV 3W
Series E	Clearview 4-W	CV 4W
Series E- Modified	Clearview 5-W & 5-W-R*	CV 5W & 5WR
Series F	Clearview 6-W	CV 6W

\* Clearview 5-W-R has slightly tighter letter space than 5-W. The Department is using Clearview 5-W-R instead of 5-W.

Studies indicate that upper/lower-case Clearview 3-W font has a legibility distance of about 29 percent greater than all capital letters using the Highway Gothic Series D font with the same size footprint. The *MUTCD* requires upper/lower-case legend for place names.

When designing signs with a Clearview font, it is important to note that the height of the lower-case legend is approximately 82 percent of the height of the upper-case legend. Consequently, you should ignore all references in the *MUTCD* indicating that lower-case letters are to be 75 percent of the height of the upper-case legend, or that the height of the upper-case letters are to be approximately 1.33 times the loop height of lower-case letters. Also, lower-case letters with top extenders, e.g., b, d, f, h, etc., extend about 8 percent above the top of the upper-case letters.

The spacing for the Clearview font is different from Highway Gothic, but calculated in the same manner as the current spacing charts included in Section 9 of FHWA's *Standard Highway Signs and Markings* book. Specifically, calculate the spacing by using a combination of a "right side bearing" associated with the first of two letters and a "left side bearing" associated with the second letter as illustrated in **Exhibit 2-12**.

**Exhibit 2-12 Inter-letter Spacing of Clearview Font**

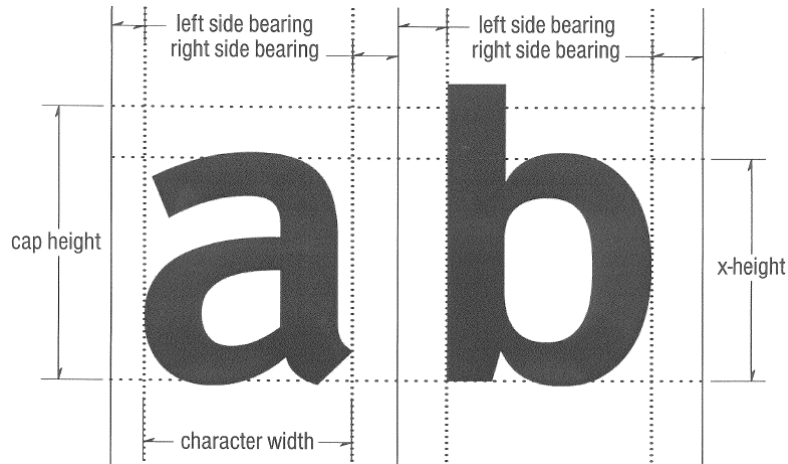

The normal letter and numerical height for guide signs on two-way, two-lane conventional roadways is 6CV 3W, and on four-lane undivided conventional roadways should be 8CV 3W, both of which previously were “D” series.

The Clearview font is a TrueType font and is compatible with PCs, sign design software, and sign makers.

**Numbered Traffic Routes**

**Types of Traffic Routes**

The main purpose of numbered traffic routes is to identify the best travel path between population centers and to indicate these “best paths” on the Official Transportation Map. There are three categories of numbered traffic routes: Interstate (I), United States (US), and Pennsylvania (PA).

All numbered traffic routes are established, eliminated, extended or relocated by the Secretary of Transportation or their designated representative. However, the American Association of State Highway and Transportation Officials (AASHTO) must also approve the establishment, elimination, or relocation of all Interstate and US numbered traffic routes.

Types of Auxiliary Classification

In addition to the regular numbered traffic route, the Department may assign the following additional auxiliary classifications to segments of US and PA traffic routes:

1. Business Routes. A business route is a route principally within the corporate limits of a larger municipality, usually traversing the central business district, which provides the traveling public an opportunity to travel through the business part of a municipality while the regular route does not pass through the congested part of the municipality. Business routes are often established on the old alignment of the regular route when the regular route is relocated around the municipality. The Business Route connects with the regular numbered route at the opposite sides of the municipality.
2. Truck Routes. A truck route is sometimes desirable to divert through truck traffic around the business or congested areas of larger municipalities when the regular route goes through such areas. Such truck routes not only help to facilitate the flow of passenger vehicles through the congested areas, but also help to reduce air and noise pollution, and assist truck drivers since they can frequently minimize their delays. In addition, truck routes may sometime be required to avoid

locations that have insufficient vertical or horizontal clearances for trucks, or bridges or highways with weight restrictions.

3. **By-Pass Routes.** A by-pass traffic route classification is sometimes assigned to a new roadway that bypasses a congested urban area. However, this classification generally confuses the through drivers since they are forced to make a decision between the regular numbered route and the by-pass. Moreover, most unfamiliar drivers are reluctant to leave a regular numbered route to follow a by-pass route. For these reasons, it is generally better to relocate the regular numbered traffic route to the new alignment and, if necessary, assign a business designation or a new traffic route number to the old alignment. The by-pass route connects with the regular numbered route at the opposite sides of the community.
4. **Alternate Routes.** Alternate traffic routes provide a route that parallels the regular route and sometimes offers advantages as a scenic view. However, because the unfamiliar drivers do not know whether the regular numbered routes or the alternate route is the best route, avoid using this designation whenever possible.

### **Establishment, Elimination, or Revision of Any Numbered Traffic Route**

#### Public Relations

Review proposed traffic route changes with county planning agencies, municipal officials and the local chambers of commerce, particularly in urban areas and other locations where businesses use the numbered traffic route in their advertising or as an address. This will not only facilitate good public relations but will provide advance information to businesses so that they can plan and implement any required changes in their advertising and/or address.

#### General Guidelines

To be of maximum benefit to the public, all numbered traffic routes must either be continuous across the Commonwealth, or must end at another numbered traffic routes. All numbered traffic routes should also be continuous, that is, they should not stop and restart at a subsequent location.

Engineering Districts should work with adjoining states to attempt to extend Pennsylvania's numbered traffic routes into their state and vice versa, and to keep the same number whenever possible.

#### District Requests

In order to facilitate the approval of a traffic route change (establishment, elimination, or revision), the Engineering District must submit the following to the Central Office:

1. A request similar to the example in the [Chapter 2 Appendix](#), page [2-115](#). This request would include a brief justification and a tentative date for the implementation of the proposed change.

This request should also provide a route description for those portions of highway where a proposed elimination or relocation would occur:

- Provide the route description from south to north, or west to east for two and three-lane two-way conventional roads. For one-way roadways and all roadways with four or more lanes, provide the description in both directions of travel. Use the format shown in the [Chapter 2 Appendix](#) to request a change.
- Use the currently assigned SRs and segments. If the SR numbers and/or segments are to be changed, coordinate all efforts through the District RMS Coordinator and the Roadway Management Division of the Bureau of Maintenance and Operations (BOMO).

2. One copy of a reproducible map or sketch indicating the proposed establishment and/or elimination. As an alternate to the reproducible map or sketch, provide a minimum of nine color-coded copies of a map. It is desirable to have all control points (transition points from one SR to another - or other official identification data if not an SR, beginning and end points, etc.) identified by SR Number, segment and offset (or other identification data if not a State Route).
3. A listing of all physical limitations of the proposed establishment or relocation, similar to the example in the [Chapter 2 Appendix](#), page 2-116.
4. The local authority must complete three original agreements (see the [Chapter 2 Appendix](#), page 2-118) between the local authority and the Department for the establishment of all proposed traffic routes over a local road. A copy of a resolution designating signature authority (see the [Chapter 2 Appendix](#), page 2-122) must also be attached to each agreement.

### Requests to Change US and Interstate Routes

In addition to the items listed above, approvals for the establishment, elimination or revision of Interstate, US, and US Bicycle numbered traffic routes comes under the jurisdiction of AASHTO's "Special Committee on U.S. Route Numbering." Although all changes technically come under their control, the Department is only seeking their approval when the change involves any of the following:

1. Another state.
2. The relocation of the junction with another Interstate or US numbered route.
3. The beginning or ending location of the route.
4. The length of the route changes by more than 0.5 mile.

If any of the above applies, the Engineering District needs to provide an electronic copy of the AASHTO application for their "Special Committee on U.S. Route Numbering" to the Central Office

The homepage for AASHTO's "Special Committee on U.S. Route Numbering" is at <http://cms.transportation.org/?siteid=68&pageid=1538>. This site includes the committee's "*United States Numbered Highways*" book, which in turn includes their established policies and a route-by-route description of all US numbered traffic routes. This homepage also includes a link for the [application](#) to make changes in an Interstate Route, US Route, or US Bike Route.

### Route Marker Assemblies

#### General

Erect Route Marker Assemblies along numbered traffic routes on all approaches to the intersection of other numbered traffic routes, and may be erected on the approaches to numbered routes on unnumbered major State highways.

Where two or more numbered traffic routes follow the same section of highway, the Route Markers for Interstate, U.S., or Pennsylvania routes shall be mounted in that order from the left in horizontal arrangements and from the top in vertical arrangements. Moreover, within these three types of routes, Route Markers for lower-numbered routes shall be above or to the left of the higher-numbered routes.

Within groups of assemblies, information for routes intersecting from the left shall be to the left in horizontal arrangements and at the center of vertical arrangements. Similarly, information for routes intersecting from the right shall be at the right or bottom, and for straight-through routes at the center or top.

### Junction Assembly

Erect the Junction Assembly along numbered traffic routes in advance of every intersection where another numbered traffic route intersects or joins the route being traveled. The Junction Assembly may also be installed along major unnumbered State highways in advance of their intersection or junction with a numbered traffic route. The route marker shall carry the number of the intersected or joined route. Where two or more routes are to be indicated, one Junction Marker can be used for the assembly and the route markers grouped in a single mounting.

Examples of Junction Assemblies are shown in Figure 2.D-6 in the *MUTCD*.

### Advance Route Turn Assembly

An Advance Route Turn Assembly shall be installed on numbered traffic routes in advance of an intersection where a turn must be made to remain on the indicated route or to follow an intersecting route. The Advance Route Turn Assembly on numbered traffic route approaches may be omitted when either of the following conditions exists:

- a) All traffic on the approach must stop at a stop sign, and the approach is a single lane, without separate turning lanes.
- b) There is inadequate longitudinal space or other physical reasons why the assembly cannot be installed.

On multilane highway approaches to an interchange or intersection, an Advance Route Turn Assembly is essential so that drivers may position their vehicles in the correct lane to follow the desired numbered traffic route. An assembly which contains an Advance Turn Arrow should not be placed where there is an intersection (or major driveway which looks like a street or roadway) between the sign assembly and the designated turn. Sufficient distance should be allowed between the assembly and any preceding intersection (or major driveway which looks like a street or roadway) that could be mistaken for the indicated turn. Where two or more routes turn, the signing may be installed as a group on a common support.

Examples of Advance Route Turn Assemblies are shown in Figure 2D-6 in the *MUTCD*.

### Directional Assembly

A Directional Assembly shall be installed on numbered traffic routes at all intersections where a turn must be made to remain on a route, to follow an intersecting route, or to indicate a straight-ahead movement to follow an intersecting route. Uses of Directional Assemblies are:

- Straight-through movements of a numbered traffic route should be indicated by a Directional Assembly with a Route Marker displaying the number of the continuing route, a Cardinal Direction Marker, and a vertical arrow. A Directional Assembly should not be used for a straight-through movement in the absence of other assemblies indicating right or left turns, as the Confirming Marker beyond the intersection normally provides adequate guidance.
- Turn movements (as indicated by an Advance Route Turn Assembly) shall be marked by a Directional Assembly with a Route Marker displaying the number of the intersected or continuing route, a Cardinal Direction Marker, and a single-headed arrow pointing in the direction of the turn.
- The beginning of a route (as indicated in advance by a Junction Assembly) shall be marked by a Directional Assembly with a Route Marker displaying the number of that route, a Cardinal Direction Marker, and a single-headed arrow pointed in the direction of the turn.



- The end of a route shall be marked by a directional assembly with an END Marker and a Route Marker displaying the number of the route.
- An intersecting route (as indicated in advance by a Junction Assembly) shall be marked by one or two Directional Assemblies (one if one direction or two if two directions), each with a Route Marker displaying the number of the intersected route, a Cardinal Direction Marker, and a single-headed arrow pointed in the direction of movement on that route.

Examples of Directional Assemblies are shown in Figure 2D-6 of the *MUTCD*, and recommended locations for directional assemblies are as follows:

- a) Directional Assemblies should be located on the near right-hand corner of the intersection.
- b) At major intersections and at Y or offset intersections, it is often desirable to install additional assemblies on the far right-hand or left-hand corner to confirm the near-side assemblies.
- c) When the near right-hand corner position is not practical for Directional Assemblies, the far right-hand corner is the preferred alternative, with oversize signs if necessary for legibility.
- d) If cross traffic interferes with the visibility of a Directional Assembly, place the assembly where it can be read at close range as determined by engineering judgment.

## Additional Route and Destination Guidance Signs

### Confirmation Assemblies

The Confirmation Assembly shall be installed just beyond intersections of numbered traffic routes and should be installed beyond other major intersecting streets or highways. Care should be taken to erect the Confirmation Assembly where it is highly visible to drivers. Examples of confirmation assemblies are shown in each example in Figure 2D-6 of the *MUTCD*.

### Trailblazer Assemblies

Trailblazer Assemblies are located at strategic locations to indicate the direction to the nearest or most convenient point of access to a specific numbered traffic route or other special road facility. Trailblazer Assemblies indicate that the road or street where it is posted is not a part of the indicated route, but that the driver is merely being directed progressively to the route.

When a Trailblazer to a highway facility is installed, it is essential that, from that point, additional trailblazers or other appropriate directional signing, consistent with this policy, be provided at other key downstream locations en route to that highway facility.

Trailblazer Assemblies may be erected with other route marker assemblies, or alone, in the immediate vicinity of designated facilities. In addition, Trailblazer Assemblies may be used to guide drivers to a freeway on-ramp from a partial interchange where access to both directions of the freeway is not available.

### Destination Signs

Destination Signs may be installed at, or in advance of, intersections to direct motorists to cities, boroughs, towns, villages, or other important destinations. These signs normally carry the names of two or three major terminal destinations – one straight ahead along the route and one in each direction along the intersecting roadway. The destination that is straight ahead is optional; however, if used, it is the first name on the sign, the destination to the left is second, and the destination to the right is on the bottom. (More

than one destination may be shown to the left or right; however, the maximum number of destinations on a sign should not exceed three.)

If there is more than one destination shown in any direction, the name of the nearest destination shall appear above that of any further away. In the case of overlapping routes, only one destination in each direction should be shown for each route.

The distance to a destination, in the nearest number of whole miles, may also be shown on the destination sign. Distances should be measured to the center of the destination.

If adequate longitudinal space does not exist for proper spacing of all sign assemblies, the destination sign may be installed on the same posts with the advance route turn or directional assemblies.

Examples of destination signs are shown in Figure 2D-6 of the *MUTCD*.

### Distance Signs

Distance signs should be installed on all numbered traffic routes leaving a city, borough, or town and beyond intersections of numbered traffic routes in rural areas. These signs normally carry the names of two or three destination points. The top name should be that of the next place along the route having a post office, railroad station, route number or the name of an intersected highway, or other significant geographical identity that is shown on the Department's Official Transportation Map. The lowermost name should be the next control city along the route. If three destinations are shown, the middle line should be a minor terminal prior to the control city. If more than one minor terminal exists prior to the control city, the name on the middle line may be varied on successive distance signs.

The control city should remain the same on all successive signs throughout the length of the route until that destination is reached. An exception to this is when the route divides at some distance ahead to serve two control cities of similar importance. If the two destinations cannot appear on the same sign, the names of the two control cities may be alternated on succeeding signs. On the route continuing into another State, destination(s) in the adjacent State should be shown.

Examples of distance signs are shown in Figure 2D-6 of the *MUTCD*.

### Advance Street Name Signs

Advance Street Name (D3-2, D3-3) signs are encouraged on numbered traffic routes when the speed limit is greater than 35 mph, and the roadway has two or more through travel lanes in each direction.

If an Intersection Series warning sign, or a Stop Ahead (W3-1) or Signal Ahead (W3-3) sign is used in advance of the intersection, the preferred scenario is to use a Single-Line Advance Street Name (W16-8P) or Double-Line Advance Street Name (W16-8AP) sign below the warning sign as discussed in the Section [Advance Street Name Signs](#) on page 2-22 instead of installing an independently-mounted D3-series sign.

### Longitudinal Placement

The guidelines shown in [Exhibit 2-13](#) should be considered when locating Route Marker Assemblies, Destination Signs, Distance Signs, and Advance Street Name Signs in the field, since the exact longitudinal placement of these signs cannot be firmly established. It is more important that these signs be readable at the right time and place than to be located with absolute uniformity.

Typical installations of numbered traffic route signing are shown in the three drawings in Figure 2D-6 of the *MUTCD*.

Route Marker Assemblies, including the Route Marker and all auxiliary signs, are treated as a single sign for vertical clearance purposes.

**Exhibit 2-13 Longitudinal Placement**

- You may adjust the distances shown below to accommodate actual field conditions and to obtain proper spacing between signs.
- When installing more than one sign or sign assembly, the minimum desirable distance between sign installations should be 200 feet in rural areas and 150 feet in urban areas.
- When the speed limit or prevailing speeds are above 45 mph, greater distances from the intersection and greater spacing between sign installations are desirable.

Sign or Sign Assembly	Urban Area	Rural Area
<b>Junction Assembly</b>	<ul style="list-style-type: none"> <li>• In block before intersection.</li> </ul>	<ul style="list-style-type: none"> <li>• Not less than 400 feet in advance of intersection.</li> </ul>
<b>Advance Route Turn Assembly</b>	<ul style="list-style-type: none"> <li>• Approximately 300 feet in advance of intersection.</li> <li>• May omit when all traffic on the approach must stop at a stop sign, and the approach is a single lane, without separate turning lanes.</li> <li>• May omit because of inadequate longitudinal space or other physical reasons.</li> </ul>	<ul style="list-style-type: none"> <li>• Not less than 400 feet in advance of intersection.</li> <li>• May omit when all traffic on the approach must stop at a stop sign, and the approach is a single lane, without separate turning lanes.</li> <li>• May omit because of inadequate longitudinal space or other physical reasons.</li> </ul>
<b>Destination Sign</b>	<ul style="list-style-type: none"> <li>• Not less than 150 feet in advance of intersection.</li> <li>• At the intersection on a one-lane approach where all traffic must stop at stop sign.</li> <li>• May combine with advance route turn or directional assemblies if space is limited.</li> </ul>	<ul style="list-style-type: none"> <li>• Not less than 200 feet in advance of intersection.</li> <li>• At the intersection on a one-lane approach where all traffic must stop at stop sign.</li> <li>• May combine with advance route turn or directional assemblies if space is limited.</li> </ul>
<b>Directional Assembly</b>	<ul style="list-style-type: none"> <li>• Near right-hand corner of intersection.</li> <li>• Alternate location may be far right-hand corner or most suitable location based on engineering judgment.</li> </ul>	<ul style="list-style-type: none"> <li>• Near right-hand corner of intersection.</li> <li>• Alternate location may be far right-hand corner or most suitable location based on engineering judgment.</li> </ul>
<b>Confirming Assembly</b>	<ul style="list-style-type: none"> <li>• Normally no more than 100 feet beyond the far shoulder or curb line of all intersection numbered traffic routes and major intersecting streets or highways.</li> <li>• Beyond the built-up area of any city, borough, or town.</li> </ul>	<ul style="list-style-type: none"> <li>• Normally no more than 300 feet beyond the far shoulder or curb line of all intersection numbered traffic routes and major intersection streets or highways.</li> <li>• Beyond the built-up area of any city, borough, or town.</li> </ul>

Sign or Sign Assembly	Urban Area	Rural Area
	<ul style="list-style-type: none"> <li>Should be installed at intervals approximately one-half mile apart.</li> </ul>	<ul style="list-style-type: none"> <li>Should install at intervals approximately 2 miles apart in built-up areas.</li> <li>May install at intervals of approximately 5 miles in areas with little or no development and only minor intersections.</li> </ul>
<b>Distance Sign</b>	<ul style="list-style-type: none"> <li>Approximately 500 feet outside the limits of a city, borough, or town, or at the edge of the built-up area if this area extends beyond the corporate limits.</li> <li>Where overlapping routes separate a short distance from the corporate limits, the distance sign at the corporate limits may be omitted, and instead should be erected approximately 300 feet beyond the separation of the two routes.</li> <li>May be combined with confirming assembly if space is limited.</li> </ul>	<ul style="list-style-type: none"> <li>Approximately 300 feet beyond the far shoulder or curb line of all intersecting numbered traffic routes when these numbered routes are more than one mile apart.</li> <li>May combine with confirming assembly if space is limited.</li> </ul>
<b>Intersection-Related Warning Signs (W2 Series, W3-1, &amp; W3-3)</b>	<ul style="list-style-type: none"> <li>As specified in Table 2C-4 of MUTCD.</li> <li>Erection shall be based on engineering justification, and they shall not be installed solely for the purpose of facilitating advance street name signing.</li> <li>Normally, do not W2 Series signs when junction or advance route turn assemblies are present.</li> </ul>	
<b>Advance Street Name Sign</b>	<ul style="list-style-type: none"> <li>When mounted with warning sign, see intersection-related warning sign category above.</li> <li>When mounted alone, see destination sign category above.</li> </ul>	

## 2.7 Tourist Oriented Directional Signs (TODS) Policy

### Purpose, Authority, and Authorization

#### Purpose

The purpose of this policy is to establish guidelines for the installation of Tourist Oriented Directional Signs (TODS) within State highway right-of-way to guide travelers to businesses, services, and Participants in which the traveling public would have reasonable interest. These guidelines include the eligibility, location, design, installation, cost, and maintenance of these signs.

#### Authority

The provisions of this chapter are promulgated under 75 Pa.C.S. §6125(d).

**Authorization**

Only Department approved TODS may be installed within the State highway right-of-way. However, the authorization of TODS is not an endorsement of the applicant's facilities.

**Definitions**

The following words and terms, when used in this policy, have the following meanings, unless the context clearly indicates otherwise:

Administering Agent – Pennsylvania Tourism Signing Trust

Agreement – The document of agreement between the Participants in the Program and the Administering Agent, setting forth the terms and conditions of participation in the Program.

Conventional Road – Any free-access public highway other than a Freeway or Expressway.

Department – The Pennsylvania Department of Transportation.

Expressway – A divided arterial highway for through traffic with partial control of access and with interchanges at junctions with high-volume highways. For purposes of this policy, sections of Expressway with at-grade intersections will be considered as a "Conventional Road," and sections of Expressway with interchanges will be considered as "Freeway."

Freeway – A divided highway with full control of access to which the only means of ingress and egress is by interchange ramps.

General Public – The people of society who are not members of a particular organization or who do not belong to a particular group.

Local Authorities – County, municipal and other local boards or bodies having authority to enact laws relating to traffic. The term also includes airport authorities, except where those authorities are located within counties of the first class or counties of the second class.

Official Traffic Control Devices – Signs, signals, markings, and devices consistent with 75 Pa.C.S. (relating to Vehicle Code) and Department regulations, placed or erected by authority of a public body or official having jurisdiction for the purpose of regulating, warning or guiding traffic.

On-Premise Sign – A sign which is erected upon the same real property that the business, facility or point of interest is located. The signs shall only advertise the business, facility or point of interest located thereon.

Participant – An eligible business entity that is issued a contract by the Administering Agent for TODS.

PennDOT – Pennsylvania Department of Transportation.

Rural Area – Any geographic area which is not included in an Urban Area on the Department's County Functional Classification Maps.

Rural Conventional Road – Any public Conventional Highway in a Rural Area.

Seasonal Business – Any business which is not operated on a year-round basis.

Secretary – The Secretary of Transportation.

Signing District – A geographical area for which a governmental sponsor has entered into an Agreement with the Department to coordinate, provide, install and maintain all signing authorized by and in conformance with this policy after approval by the Department, without bias to any businesses and at no cost to the Department.

Supplemental Guide Sign - A sign used to provide information regarding destinations and attractions accessible from an interchange other than places displayed on the standard interchange signing.

Tourist Oriented Directional Signs (TODS) – A 72"x24" or 48"x16" directional sign (D7-4) with white legend on blue or brown background that indicates the name of, and gives directional guidance to the Participant's location. These signs are located for individual Participant(s), following PennDOT's TODS Signing Policy, and are not part of a larger signing system.

TODS Assembly – A single TODS installation consisting of sign posts, anchor posts, and a maximum of three individual TODS.

Urban Area – Any geographic area with a population of 5,000 or more inhabitants, with boundaries fixed by State and local officials in cooperation with each other, approved by the Secretary, and designated as an Urban Area on the Department's County Functional Classification Maps.

Urban Conventional Road– Any public conventional highway in an Urban Area.

## General Eligibility Requirements

### General

The Participant shall be open to all persons regardless of race, color, religion, ancestry, national origin, sex, age or handicap; be maintained in good repair; and comply with all Federal, State and local regulations and statutes for public accommodations concerning health, sanitation and safety. Pursuant to federal regulations promulgated under the authority of The Americans with Disabilities Act, 28 C.F.R. §35.101, et seq., the Participant understands and agrees that no individual with a disability shall, on the basis of the disability, be excluded from the Participant.

### Distance to Services

Except as otherwise provided in this policy, on all Conventional Roads, the maximum distance from the intersection for which Participants can be trail blazed and qualify for TODS shall be 5.0 miles.

### Local Ordinance

As a matter of policy in deference to local governments for this program, TODS shall not be installed when prohibited by local ordinance.

### Admission Charges

If a general admission is charged, it shall be collected upon entry and any other charges shall be clearly displayed, at the place of entry.

### Annual Attendance

There is no minimum annual attendance requirement. No Participant shall be excluded from the TODS Program based on attendance.

### Hours of Operation

Participants other than arenas, schools, colleges/universities, campgrounds, cultural centers, fairgrounds, farm markets, religious sites, roadside farm markets, and military bases shall maintain regular hours and schedules and be open to the General Public at least 6 days each week for at least 30 days per calendar

year. In addition, farm markets and roadside farm markets shall maintain regular hours and schedules and be open to the General Public at least 2 days each week during the normal business season.

### **Other Signs**

TODS will not be authorized if an illegal advertising sign exists along any State highway for that specific business, or if a legal advertising sign exists on the same highway approach as the request for a TODS. In addition, if the Participant has in place any other Department-approved signing, additional signing or redundant signing will not be authorized on the same highway approach.

### **Sufficient Space**

Space must exist to install signs at all locations along the route to the Participant where a turn is required.

### **On-Premise Sign**

The Participant shall have an On-Premise Sign identifying the name of the facility. If the facility or its on-premise signing is readily visible from the highway, a TODS shall not be placed immediately in advance of the business.

### **Parking Accommodations**

The Participant shall have adequate on-premise or available on-street parking for patrons.

### **Road System**

The location of the Participant shall not require motorists to perform any illegal movements or U-turns, and the roads shall be capable of handling the anticipated traffic volume and types of traffic. Motorists shall be able to readily return to the highway and proceed in the original direction of travel after visiting the Participant. This may result in the Participant being required to install signing to guide the motorist to their original direction of travel.

### **Route Continuity**

TODS will be installed in advance of all necessary turns subsequent to the initial TODS installation. If a TODS is required on a local roadway between a State highway and the Participant, the Local Authorities must authorize the installation of the TODS on their roadway prior to the installation of TODS on any State highway that would direct motorists to that local roadway. The Pennsylvania Tourism Signing Trust will be responsible for the physical installation of the TODS after authorization by the Local Authorities.

## **Additional Eligibility Requirements**

### **General**

Additional eligibility requirements may apply depending on the type of highway and the type of area where the TODS are to be installed. The requirements are less restrictive for TODS installed along rural Conventional Roads than for TODS installed along Urban Conventional Roads.

### **Local Approval**

TODS may be authorized along any Conventional Road either urban or rural for eligible types of Participants as defined below, which meet the general eligibility requirements, and are approved by the local municipalities within which the TODS are to be located. Local approval is required as a matter of policy in

deference to local governments for this program. The approval of the Local Authorities is not required for a TODS installed to direct motorists to Participants operated by State or Federal agencies or TODS which trailblaze a Participant in the Logo program.

## Eligible Types of Participants

### Any facility meeting the requirements of the definitions listed below

#### (a) Commercial

**Amusement Park:** A permanent facility that may include structures and buildings, where there are multiple devices for entertainment, including rides, booths for the conduct of games and buildings for shows.

**Brewery :** A licensed site which shall be open to the General Public for tours, tasting and sales, a minimum of 1,500 hours per year, on-site brewing and provide an educational format for informing visitors about beer and beer processing.

**Caverns and Other Unique Natural Areas:** A naturally occurring area or site of interest to the General Public. May include caverns, waterfalls, caves, or special rock formations.

**Commerce Park:** A group of small business facilities, at least 25 acres in size, recognized and signed as a commerce park by Local Authorities.

**Drive-In Theatre:** An outdoor facility for the public showing of movies projected onto at least one large screen for viewing by patrons from their vehicles. Facility shall operate at least 30 days per year, have a concession area open during show times and provide restrooms with running water and flush toilets.

**Facility Tour:** A facility such as a plant, factory or institution which conducts daily or weekly tours for the General Public on a regularly scheduled basis year round.

**Gaming Entity:** A facility licensed under Act 71-2004, Amending Title 4 (Amusements) Pa C.S. which authorizes certain gaming sites.

**Off-Track Betting Facility:** A facility which provides off-premise wagering as authorized by Act 1988-127.

**Racetracks and Speedways:** A permanent facility used for the primary purpose of presenting organized animal or vehicle racing events.

**Roadside Farm Market:** A stationary retail sales establishment operated by one or more farmers for the purpose of selling farm and food products directly to consumers. Operations by which the consumer harvests their own farm or food products shall be considered roadside farm markets. Roadside farm markets shall be open at least two days per week throughout the harvest season or year. On-premise or legal on-street parking shall be available.

#### **Specialty Shop District:**

**Antique/Craft/Flea Market:** An establishment or group of establishments comprised of shops/vendors that specialize in the sale of antiques, crafts, or flea market items. A group of 1 to 5 such establishments must have at least 2,400 square feet of cumulative retail space.

**Shopping Center:** A group of 30 or more retail stores in a traditional shopping center or mall.

**Specialty Shops:** A group of 5 or more specialty shops/vendors that offer goods or services of unique interest to tourists or whose structures have a prevalent architectural style of interest to tourists and which derives a major portion of its income during normal business season from motorists that do not reside in the immediate area as recommended by the Tourist Promotion



Agency. The goods or services shall be readily available to tourists without the need for scheduling appointments or return visits.

*Town Shopping Area*: An area in a town or village, that includes 5 or more retail shops including at least one specialty shop and includes other public service facilities or destinations such as libraries, museums, courthouses, etc. The area should have prevalent architectural style of interest to tourists, or must be recommended by the local Tourist Promotion Agency as being representative of the tourism theme of the region.

*Winery*: A licensed site which produces a maximum of 200,000 gallons of wine per year. Sites shall maintain a minimum of 3,000 vines or 5 acres of vineyard in the Commonwealth.; be open to the General Public for tours, tasting, and sales, a minimum of 1,500 hours per year, and provide an educational format for informing visitors about wine and wine tasting.

*Zoos, Zoological Gardens and Animal Parks*: A place where animals are kept, often in combination of indoor and outdoor spaces. Must have facilities which are open to the General Public.

### **(b) Cultural/Institutional**

*Arena*: A stadium, expo center, sports complex, auditorium, convention center, civic center or racetrack, which has a seating capacity of at least 5,000.

*Business District*: An area within a city or borough which is officially designated as a business district by the local officials.

*College or University*: An institution which is approved by a nationally-recognized accreditation agency and which grants degrees.

*Courthouse/Government Buildings*: A public building , structure, or complex used by a Federal, County, State or municipal government for the purpose of convening official legal activities.

*Fairground*: A commercially-operated tract of land where fairs or exhibitions are held, and which has permanent buildings included but not limited to livestock exhibition pens, exhibition halls, bandstands, etc.

*Library*: A repository for literary and artistic materials, such as books, periodicals, newspapers, recordings, films, and electronic media, kept and systemically arranged for use and reference.

*Military Base*: A facility operated by the State or federal government for training or support of military troops, or for inventorying and warehousing military equipment.

*Museum*: A facility that cares for and exhibits works of artistic, cultural, or scientific value that are cared for and exhibited to the General Public.

*Observatory*: A facility designed and equipped for making observations of astronomical, meteorological, or other natural phenomena.

*Religious Site*: A shrine, grotto or similar type site, which is of a unique religious nature. Facilities whose sole purpose is to host routine worship services are not eligible.

*Theaters and Performing Arts Centers*: A facility for the performing arts, exhibits, or concerts, which has a minimum occupancy capacity of 150 people.

### **(c) Historical/Architectural**

*Historical Site*: A designated National Historic Site or a structure or place of historical, archaeological or architectural significance listed on or eligible for listing on the National Register of Historic Places maintained by the US Department of Interior or otherwise designated by the Pennsylvania Historical and

Museum Commission (PHMC), or a County Historical Commission or Agency. The site must be accessible to the General Public and provide a place where visitors can obtain information about the historic site.

Historic Sites may include the following types, provided they meet the above criteria:

- Encampments and Battlefields
- Forts
- Houses
- Commercial Buildings
- Farms, Farmsteads, and Barns
- Religious Sites, Places of Worship, Cemeteries, and Monuments
- Mills and Factories
- Furnaces
- Coal Mines and Coke Ovens
- Bridges
- Tollhouses
- Canals
- Railroad Stations
- Cemeteries

*Historic District:* A district or zone listed on or eligible for listing on the National Register of Historic Places maintained by the U.S. Department of Interior or otherwise designated by the Pennsylvania Historical and Museum Commission (PHMC), or a County Historical Commission or Agency. Historic districts shall provide the General Public with a single, central location such as a self-service kiosk or welcome center, where visitors can obtain information concerning the historic district.

Historic Districts may include the following types, provided they meet the above criteria:

- Historic Residential Streets
- Shopping Streets and Districts
- Court Houses and Public Buildings
- Railroad lines
- Canals

#### **(d) Recreational**

*Boat Launch:* A facility open to the General Public for docking or launching boats.

*Campground:* A facility with continuous operation for at least 6 months per year and a minimum of 20 overnight sites. An attendant shall be available during the hours of operation and restrooms with showers, running water and flush toilets shall be available. Accommodations sold on annual or time-sharing basis or otherwise not available for General Public use will not be counted toward the minimum requirements.

*Canoeing and Rafting:* Areas open to the General Public with established canoeing and rafting facilities.

*Golf course:* A facility opens to the General Public and offering at least nine (9) holes of play. Miniature golf courses, driving ranges, chip and putt courses, and indoor golf shall also be eligible.

*Hiking and Biking Trails/Routes:* Areas designated for recreational hiking, biking, walking, etc. which are publicly accessible, and owned and maintained by either the Local or County government or Pennsylvania

Department of Conservation and Natural Resources (DCNR), or non-profit organizations. TODS will only be installed at locations that direct the motorist to an established trail head with parking facilities.

*Horseback Riding Areas*: Areas designated for horseback /ponyback riding for the General Public.

*Hunting and Fishing Areas*: Areas so designated and under jurisdiction of the Pennsylvania Game Commission or the Pennsylvania Fish and Boat Commission.

*State and National Park, Recreation Area, Forest*: An area so designated and under the jurisdiction of DCNR, Pennsylvania Historical and Museum Commission (PHMC), National Park Service, U.S. Department of Interior, County Government, or non-profit organization with facilities open to the General Public.

*Ski Area*: A downhill skiing area with equipment rentals, or a cross country ski area with equipment rentals and a minimum of 5 miles of marked and groomed trails.

*Snowmobile Trails and Winter Sports Areas (excluding Ski Areas)*: Areas with marked snowmobile trails, ice skating rinks, snowboarding, sleigh rides, and toboggan runs, which are open to the General Public. TODS will only be installed at locations that direct the motorist to an established trail head with parking facilities.

*Sports Facilities*: Regional (multi-jurisdictional) facilities such as minor league and little league baseball fields, and school recreational fields.

*Water Skiing*: Areas designated for water skiing, jet skiing, or motorboats.

#### **(e) Tourist Services**

*Bed and Breakfasts*: A private residence located in a Rural Area that contains ten (10) or fewer bedrooms used for providing overnight accommodations to the General Public, and which breakfast is the only meal served and is included in the charge for the room. Must be rated in accordance with national or state standards for bed and breakfasts; rating may be performed by the local Tourist Promotion Agency.

*Country Inn*: A facility located in a Rural Area that contains 25 or fewer rooms for providing overnight lodging accommodations to the General Public, and that at a minimum provides full service dining for morning and evening meals. Must be rated in accordance with a national or state standards for country inns; rating may be performed by the local Tourist Promotion Agency.

*Historic Hotel*: A facility which must be located within a building that is at least 50 years of age. And be listed on or eligible for listing on the National Register of Historic Places, or which is recognized by State, National or a County Historical Society as having historical significance; and currently holds itself out by any means, including advertising, license, registration with any innkeepers' group, convention listing association, travel publication or similar association or with any government agency, as being available to provide overnight lodging or use of facility space for considerations to persons seeking temporary accommodations.

*Hospital* : An institution providing primary health services and medical or surgical care to persons, primarily inpatients, suffering from illness, disease, injury, deformity and other abnormal physical or mental conditions. The facility must have 24-hour emergency care with a doctor on duty at all times

*Resort*: A facility with at least 75 rooms and those recreational amenities normally present at a resort, and which is the main focal point of a vacation.

*Regional Restaurant*: An establishment in a Rural Area where food and drink are prepared, served and consumed on premise and provided by full-table service. The facility must provide a minimum of eighty (80) indoor seats. Must be a local operation uniquely associated to the region. Drive-through only establishments and franchised or corporate-owned chain restaurants are excluded from this type of eligible Participant.

*Pennsylvania Visitor Information Centers:* A facility where the primary purpose of its operation is to provide, information and tourist supportive services. Must be approved by the Department of Community and Economic Development.

#### **(f) Transportation**

*Airport:* A public-use facility licensed by the Department for the landing and takeoff of aircraft, and for receiving and discharging passengers and cargo.

*Heritage Roads, Historic Routes, Byways or Trails:* a road, trail, or route designated by DCNR, PennDOT, U.S. Department of Interior, or other agency as being part of a national or state recognized historic or heritage park, trail system, or byway.

*Railroad Trips:* Scenic or historic railroad trips recognized by the local Chamber of Commerce, the regional Tourist Promotion Agency, DCNR, or Pennsylvania Historical and Museum Commission.

*Railroad/Bus Stations:* A passenger terminal utilized for discharging and picking up passengers and for ticketing.

*Scenic Overlook:* An area, usually at the side of the road, where persons can observe a scenic area such as significant geology, unique botanical resources, or expanses of land such as farmlands, woodlands, or across mountaintops or ridges.

*Water Tours:* A guided tour on a body of water using a passenger carrying vessel with access to a docking facility and adequate legal parking.

*Waterfronts:* Areas with access to and views of the rivers of the Commonwealth, which are recognized by the County or the State as having significant recreational or cultural value and are open a minimum of 30 days per calendar year.

## **Location, Spacing, and Design of TODS for Conventional Roads**

### **General**

TODS may be installed to direct traffic to each entrance of an eligible Participant beginning at the nearest access point from a Conventional Road with an average of at least 2,000 vehicles per day. TODS shall not be authorized to direct motorists onto or off of any Freeway or Expressway. TODS with straight ahead arrows will not be authorized, except where the Department deems necessary to provide positive guidance.

### **Location**

Install TODS in advance of the intersection where a motorist leaves the primary highway system and at all subsequent locations where the motorist is required to turn in order to travel to the Participant. When the Participant, or the Participant's On-Premise Sign, is readily visible from the highway, do not install a TODS immediately in advance of the Participant. All TODS should be on the right-hand side of the highway and where sufficient space is available.

TODS should be located to take advantage of natural terrain, to minimize the impact on the scenic environment, and to avoid visual conflict with other signs within the highway right-of-way. Department-approved breakaway sign supports shall be used. When an at-grade intersection on a primary highway is replaced with an interchange, the location shall no longer qualify for TODS and any TODS previously erected shall be removed.

TODS shall be located so as not to interfere with, obstruct, or divert driver's attention from any official traffic control device. Official Traffic Control Devices placed at intersection approaches subsequent to the

placement of TODS shall have precedence as to location and may require the relocation of TODS. In general, TODS shall be installed at least 200 feet from other official traffic control devices.

TODS shall be positioned in such a manner that does not restrict drivers' vision when entering the highway from side roads or driveways.

TODS shall not be displayed for any business which is readily visible and identifiable within 200 feet along the highway.

### Spacing

TODS shall be located not less than 200 feet or more than 1,320 feet in advance of a location where a turn is required from the highway. At intersections where more than one TODS assembly is required, the minimum spacing between such assemblies should be 200 feet. The maximum number of TODS assemblies on any intersection approach shall be two.

### Design of TODS on Conventional Roads

TODS layout shall be in accordance with [Exhibit 2-14](#). Each TODS shall have one or two lines of legend which should generally be limited to the name of a single Participant or an abbreviation thereof. The names of multiple participants or businesses will not be included on a single TODS. A maximum of 16 letters and spaces shall be permitted on each line unless specific approval for an increased number of letters and spaces is granted by the Department. Legends shall not include promotional advertising.

Generally, a directional arrow shall be required. If the distance to the business is 1/4 mile or greater, the distance in miles should be included below the arrow. The distance may be 1/4, 1/2, 3/4, or the nearest whole mile. When necessary, the sign may have a full-width message without a directional arrow, with a second line message such as "DRIVEWAY ON LEFT," "LEFT 500 FEET," , etc.

The standard TODS size shall be 72"x24". Where insufficient right-of-way or roadside exists, smaller TODS measuring 48"x16" may be authorized. All TODS shall be of the same size where multiple TODS are installed on a single sign assembly.

TODS shall have white reflectorized legend and border on a blue reflectorized background. A brown reflectorized background may be authorized for State and National parks, recreational areas and historical sites. All TODS shall be fabricated by a Department-approved sign manufacturer using a Department-approved retroreflective sheeting.

Generic symbols may be used on TODS at the beginning of the legend area. Any generic symbol included in [Exhibit 2-15](#), or included as a recreational or cultural interest area symbol in either the FHWA's *Standard Highway Signs and Markings* book or the *Manual on Uniform Traffic Control Devices (MUTCD)* is permitted for use.

### Arrangement

TODS will normally be installed as independent sign assemblies. A maximum of six TODS shall be authorized for installation on any approach to an intersection.

When the number of TODS at an intersection approach is three or less, TODS shall be grouped together with signs displaying arrows pointing to the left above those pointing to the right. If any TODS with straight-ahead arrows (as is the case where the road turns and the access is straight-ahead) are authorized, the TODS for the straight-ahead Participant shall be installed above any TODS for Participants to the left or to the right; except that seasonal Participants shall be mounted below all other signs regardless of orientation of directional arrow.

If the number of TODS at an intersection approach is more than three, TODS shall be grouped as two separate TODS assemblies with a maximum of three TODS per assembly. The first TODS assembly should generally be limited to Participants with straight-ahead or left arrows, and the second TODS assembly will generally be limited to Participants with right arrows. Install Seasonal Businesses on the second assembly.

If more than one business exists in a given direction, the TODS for a closer business shall be mounted above the more distant business.

The top of the TODS assembly shall be a minimum of 9 feet above the ground. The bottom sign shall be a minimum of 5 feet above the near edge of roadway and 7 feet above the ground where pedestrian traffic may exist.

## **Sign Installation, Cost and Maintenance**

### **Installation**

The Pennsylvania Tourism Signing Trust will be responsible for the manufacturing and installation of all TODS (except for Airports and Signing Districts which fall under the purview of the Department) in accordance with PennDOT standards and specifications. At locations where sidewalks exist, the Pennsylvania Tourism Signing Trust will obtain municipal authorization for installation of TODS. If TODS are required on a local highway for route continuity, the Pennsylvania Tourism Signing Trust shall obtain municipal authorization prior to the installation of any sign.

### **Costs**

Each applicant shall be responsible for the costs established by the Pennsylvania Tourism Signing Trust for installation of each TODS. In addition, the applicant shall be responsible for all costs incurred due to the adjustment, relocation, covering or removal of TODS to comply with the requirements set forth in this policy.

With all new applications, the applicant is required to pay an application fee which must be included with the submission of the TODS application. The application fee will not be used to offset any portion of the costs for installation of each TODS. Participants requesting replacement TODS for an approved facility are not required to pay an application fee.

### **Maintenance**

The Participant is responsible for all maintenance costs performed by the Pennsylvania Tourism Signing Trust. Such maintenance costs will not exceed the cost established at the time of maintenance of a new TODS. The Department reserves the right to maintain, and adjust all signs within its right-of-way. If a replacement TODS is necessary due to deterioration, traffic accident or vandalism, the Participant shall be responsible for the sign replacement costs.

The Pennsylvania Tourism Signing Trust Staff will notify Participants of any TODS in a state of disrepair, and the Participant will be responsible for costs associated with any maintenance. Any maintenance costs which are not paid by the Participant will result in removal of their TODS and termination from the program.

Existing TODS which were installed prior to the Pennsylvania Tourism Signing Trust assuming administrative responsibilities for TODS under this policy will only become the responsibility of the Pennsylvania Tourism Signing Trust once maintenance is required. At that time, the participant will be required to execute an agreement with the Pennsylvania Tourism Signing Trust and be subject to their fee structure as explained under the section entitled Costs above. This also applies to TODS which serve as trailblazers for

supplemental guide signs. Geographic areas covered by Signing District Agreements will continue to be the responsibility of the sponsor for those agreements.

### **Missing Signs**

It is the responsibility of the Participant to review their TODS and to advise the Pennsylvania Tourism Signing Trust of any missing signs as soon as the problem exists. The Participant will be responsible for costs associated with the replacement of missing TODS and any costs which are not paid will result in the removal of remaining TODS, if applicable, and termination from the program.

### **Seasonal Participants**

#### **Location of Seasonal TODS**

The order of installation of TODS, whether seasonal or non-seasonal, shall be as prescribed under the section on arrangement.

#### **Covering or Removing Signs**

When TODS are approved for businesses that are not operated on a year-round basis, the Pennsylvania Tourism Signing Trust will cover or remove the TODS for any period of time greater than 15 days in which the business is not operating except for TODS with a "SEASONAL" supplemental message. The Participant shall be responsible for all associated costs including but not limited to removal, storage and reinstallation of the sign panel, and posts if required.

### **Removal of a TODS**

#### **General**

The Pennsylvania Tourism Signing Trust and PennDOT reserve the right to remove TODS if space is needed for necessary official traffic-control devices or if PennDOT determines that the signing is not in the best interest of the Commonwealth or the traveling public. The Participant will not be reimbursed for the sign costs.

#### **Removal of Signs**

Except where otherwise provided in these guidelines, TODS may be removed by PennDOT or the Pennsylvania Tourism Signing Trust including but not limited to any of the following reasons:

- Failure to comply with eligibility requirements set forth in the guidelines.
- Because of fire, crash, facility renovation, or similar causes, which result in a qualified Participant becoming inoperable for a period of time exceeding 15 days.
- If the facility closes for an extended period without a scheduled reopening date, or if in the opinion of the Pennsylvania Tourism Signing Trust, the owner or responsible operator does not proceed with necessary repairs within a reasonable time, the Participant shall lose its right to continued placement of its TODS.
- If the facility ceases to operate in accordance with these guidelines.
- If a Signing District is established and existing TODS do not provide consistent guidance.
- Because the TODS conflicts with road modifications or safety concerns.

## Application Procedure

### Application

Participants desiring TODS shall request an application from the Pennsylvania Tourism Signing Trust or download one from its website. Each applicant shall provide the following (for an airport contact PennDOT's Bureau of Aviation):

- A completed application form and fee. A separate application shall be submitted for each Participant's site where TODS are proposed.
- A map or neatly drawn sketch of the area to indicate the locations of the requested TODS and the location of the Participant.
- A notarized application attesting to the authenticity of the signatures. If TODS are installed and it is subsequently determined that the applicant was not truthful, the TODS shall be removed and the Participant shall be billed for the actual removal costs.
- Approval on the application from the local municipality(s) that the installation of TODS does not conflict with any local ordinances.

### Excess Number of Eligible Participants

If applications are received for any one intersection for more than the allowable number of TODS, the order of priority shall be based on the date of receipt of a properly completed application and the required fee. Once approved for TODS, the Participant shall remain eligible for these signs unless it is declared in violation of these guidelines.

### Applicant Appeals

A business may appeal a denial for TODS under Title 2, Pa. C.S., Sections 501-508 (relating to the Administrative Agency Law), by submitting a written request for a hearing within 30 days of the date of the denial notification. Businesses should submit appeals to:

Administrative Docket Clerk  
Pennsylvania Department of Transportation  
400 North Street-9th Floor  
Harrisburg, PA 17120-0096

The written request shall include a filing fee made payable to the "Commonwealth of Pennsylvania" and a copy of the denial notification.

At the time of publication, filing fees are listed at 34 Pa.B. 4081 (see <http://www.pabulletin.com/secure/data/vol34/34-31/1410.html>). Filing fees for appealing a TODS decision is a Level II fee, and comes under the category of "motorist information sign matters." Businesses may verify the current fee by contacting the Administrative Docket Clerk at 717-772-2741.



## Signing Districts

### General

As opposed to signing individual facilities from the nearest access point from a Conventional Road with an average of at least 2,000 vehicles per day, the purpose of a Signing District is to provide an overall, uniform signing concept for various facilities located in a specific municipality. A cohesive signing concept may encourage traffic flow to general destinations including, but not limited to cultural Participant areas, recreational Participant areas, shopping areas, and universities, and may then direct motorists to specific Participant locations.

### Agreement

In order to establish a Signing District, a governmental sponsor shall submit an application to PennDOT (see Exhibit [Exhibit 2-16](#) Application for Signing District) and agree to enter into an Agreement with PennDOT to coordinate, obtain, erect and maintain all signs associated with the Signing District. The governmental sponsor must ensure that all facilities eligible for signing under the provisions of these guidelines are provided an opportunity to participate in the Signing District. A public meeting shall be held to provide Participants with an opportunity to become involved. The removal of existing “illegal” or permitted advertising signs shall be evaluated to avoid and reduce sign clutter on the highways. Sign designs and color schemes will comply with those indicated in [Exhibit 2-14](#).

### Installation

Department approval shall be obtained for the proposed sign locations. An Agreement shall be executed between the parties before the manufacture or installation of any signs. The governmental sponsor shall be responsible for manufacture, installation and maintenance of signs as outlined in the Agreement.

Exhibit 2-14 TODS (D7-4)

(a) Justification. The Attraction Sign (D7-4) may be used on conventional highways to direct motorists to large tourist attractions in accordance with the Department's Attraction Signing Guidelines. One or two lines of legend may be used to identify the name or abbreviation of the attraction.

(b) Design. A rectangular directional box should generally be located on the left side of the sign for attractions that are straight ahead or to the left, or on the right side of the sign for attractions to the right. The box should generally include a directional arrow and a distance of 1/4, 1/2, 3/4 or the nearest whole mile, but the box may be eliminated if it is more appropriate to use directional information such as "DRIVEWAY ON LEFT", "LEFT 1000 FEET", etc., on the second line of legend. All legend should be "Clearview 1W, 2W or 3W" font, of the highest series possible. If necessary, the legend may be further condensed up to 35 percent. A generic symbol for hospital, campground or airport may be used in advance of the legend message.

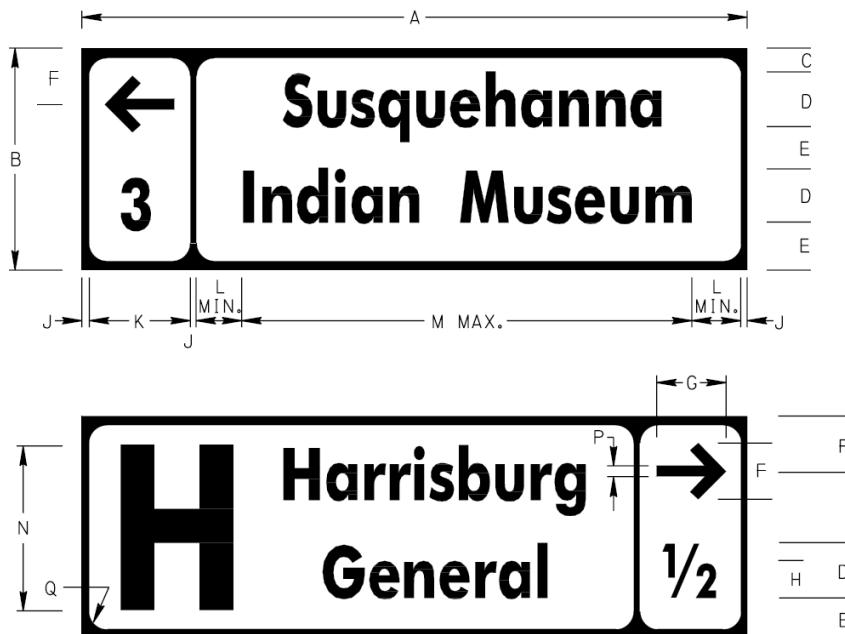

DIMENSIONS - mm (IN)													
SIGN SIZE A x B	C	D	E	F	G	H	J	K	L	M	N	P	Q
1200 x 400 (48" x 16")	50 (2)	100 (4)	75 (3)	100 (4)	125 (5)	65 (2.6)	15 (0.6)	185 (7.4)	50 (2)	870 (34.8)	275 (11)	20 (0.8)	25 (1)
1800 x 600 (72" x 24")	90 (3.6)	150 (6)	105 (4.2)	165 (6.6)	188 (7.5)	100 (4)	20 (0.8)	280 (11.2)	75 (3)	1310 (52.4)	400 (16)	30 (1.2)	45 (1.8)

COLOR:

LEGEND AND BORDER:  
WHITE (REFLECTORIZED)

BACKGROUND:  
BLUE (REFLECTORIZED)

APPROVED FOR THE SECRETARY OF TRANSPORTATION

By : *Alan C. Rowe* Date : 01-03-06  
Chief, Traffic Engineering and Operations Division  
Bureau of Highway Safety and Traffic Engineering

Exhibit 2-15 Acceptable Symbols

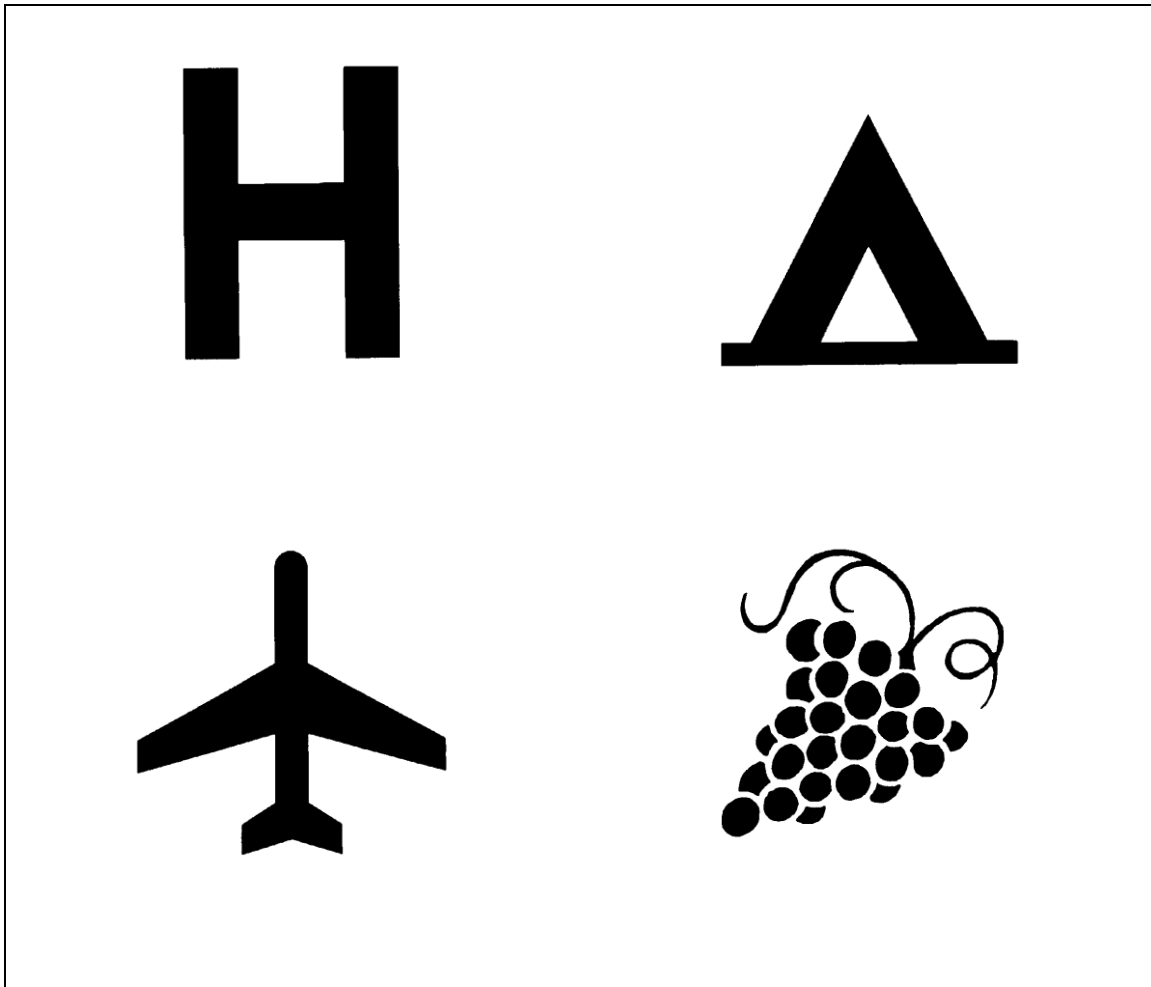

**Exhibit 2-16 Application for Signing District**

Please print or type the following information.

1. Name of Governmental Sponsor:
2. Mailing Address:
3. Name of contact person:
4. Phone number of contact person:
5. Has a map of the proposed signing district been included? _____
6. Name of Consultant:
7. Address of Consultant:
8. If consultant has not been hired, will the service of one be used? _____ If not, who will design the system?
9. Have all illegal signs been removed? _____
10. Has an inventory of existing permitted signs been completed? _____

11. Does the governmental sponsor understand that all businesses or facilities that participate in the signing district must meet one of the definitions and satisfy the General Eligibility Requirements set forth in this policy?

Yes \_\_\_\_\_ No \_\_\_\_\_

12. Are there any plans contemplated to expand the signing district beyond its boundaries and become a signing region? If yes, is there a timetable (attach or explain)?

13. Note: Execution of an agreement between the governmental sponsor and the Commonwealth designating the signing district must be completed before construction of the signs begins.

14. Do you understand all costs will be borne by the governmental sponsor? Further, the governmental sponsor may recoup some or all of the administrative costs of the program by the establishment of a fee structure for applicants.

15. Indemnification. The Governmental Sponsor shall indemnify, save harmless, and defend the Department from any and all claims, actions, damages, injuries, and/or expenses arising out of the subject Signing District or on account of any act, omission, neglect, or misconduct by an applicant or a third party.

I hereby certify that the information provided on this application is true and correct and to the best of my knowledge, and \_\_\_\_\_ (name of Governmental Sponsor) is fully prepared to move forward to completion of the signing district. It is also my understanding that if signs are installed, they may be removed by PennDOT or the Pennsylvania Tourism Signing Trust as detailed in these guidelines.

Sworn before me this \_\_\_\_\_ day of \_\_\_\_\_, 20\_\_\_\_\_.

Notary:

Signature of Representative: \_\_\_\_\_

## 2.8 Acknowledgement Signs

### General Requirements

The Federal Highway Administration (FHWA) allows the use of signs to acknowledge the provision of highway-related services. State and local programs for acknowledgment signs are growing in popularity because they can provide additional revenue for highway maintenance programs. Section 2H.08 of the MUTCD provides guidance on the use of Acknowledgement Signs.

Existing acknowledgment signs already installed do not have to be changed, but Engineering Districts need to consider the guidance when replacing or upgrading existing signs. Always attempt to follow good, basic engineering practices such as simplifying sign message content, reasonable sign sizes, and minimizing driver distraction.

Acknowledgment signs are a way of recognizing a company or business, or a volunteer group that provides a highway-related service. Acknowledgment signs include sponsorship signs for adopt-a-highway litter removal programs, maintenance of a parkway or interchange, and other highway maintenance or beautification sponsorship programs. Acknowledgment signs should clearly indicate the type of highway services provided by the sponsor. The FHWA recognizes a distinction between signing intended as advertising and signing intended as an acknowledgment for services provided. Advertising generally has little if any relationship to a highway service provided. An advertiser wants to get its recognizable message, company emblem, or logo before the public, and if possible, information on how or where to obtain the company's products or services. In most cases, if the sign goes beyond recognizing the company's contribution to a particular highway service at a specific highway site or includes telephone numbers or internet addresses, the sign is an advertising sign and not an acknowledgment sign.

This policy position is consistent with the principles and intent of several laws including 23 U.S.C. §1.23(b), 23 U.S.C. §109(d), and 23 U.S.C. §131. Section 1A.01 of the MUTCD states that "Traffic control devices or their supports shall not bear any advertising message or any other message that is not related to traffic control." This position is founded on safety and operational concerns, particularly as related to driver distraction. Highway signs and other traffic control devices convey crucial information. In order for road users to perceive and respond appropriately to critical information, we must ensure the conspicuity of traffic control devices to avoid compromising the safe and orderly movement of traffic.

### Sign Placement

With respect to placement of traffic control signs, regulatory, warning, and guide signs have a higher priority than acknowledgement signs. In fact, acknowledgment signs are the lowest priority of information-type signs and may only be placed where adequate spacing between higher priority signs is available. In no case shall an acknowledgment sign be placed such that it obscures road users' view of other traffic control devices. Therefore, follow the following minimum spacing requirements:

1. On roads with speed limits of less than 30 mph, do not place acknowledgment signs within 150 feet of any other traffic signs, except parking regulation signs.
2. On roads with speed limits of 30 to 45 mph, do not place acknowledgment signs within 200 feet of any traffic signs, except parking regulation signs.
3. On roads with speed limits greater than 45 mph, do not place acknowledgment signs within 500 feet of any traffic control signs, except parking regulation signs.

Due to public safety concerns, do not allow acknowledgment signs at the following locations:

1. On the front, back, adjacent to or around any traffic control device, including traffic signs, signals, changeable message signs, traffic control device posts or structures, or bridge piers.
2. At key decision points where a driver's attention is more appropriately focused on traffic control devices, roadway geometry, or traffic conditions. These locations include, but are not limited to exit and entrance ramps, intersections controlled by traffic signals or by stop or yield signs, highway-rail grade crossings, work zones, and areas of limited sight distance.

If the placement of an acknowledgment sign conflicts with newly installed higher priority signs, or traffic signals, or temporary traffic control devices, or other priority devices, remove, cover or relocate the acknowledgment sign.

### **Adopt-A-Highway Signs**

In the Adopt-A-Highway Program, businesses, groups of people, or individuals agree to pick up litter along a section of highway in exchange for the erection of a sign bearing their name at the beginning of the section.

The program not only helps reduce the maintenance workload, but also fosters a public awareness of the magnitude of the littering problem.

The procedures and types of signs for the program are addressed in the Adopt-A-Highway Operational Manual. In each Engineering District, the program is administered under the direction of the Adopt-A-Highway Coordinator, and the oversight of the Bureau of Maintenance and Operations (BOMO).

### **Beautification Area Signs**

The Beautification Area Sign (I47-1) and the Beautification Area Sponsor Sign (I47-2) are designed to give recognition to the individual or group of individuals that provides and maintains the plantings or other beautification efforts.

### **Sponsor-a-Highway**

The Sponsor-A-Highway program is a professional maintenance and marketing program intended to provide corporate sponsors that desire to assist in highway beautification the opportunity to fund litter removal services. The program is targeted towards freeways.

A Highway Beautification Contractor is under contract with the Department to solicit corporations that want to pay for litter removal. They market the program, perform maintenance and install signs recognizing the contribution of the companies. The Bureau of Maintenance and Operations administers the Sponsor-A-Highway program; therefore, direct any questions about the program to that office.

## **2.9 Operational Changes Requiring Transitional Signing**

### **General Discussion of Operational Changes**

As traffic patterns change at specific locations on the highway, changes are also necessary in the operational procedures and devices that control those patterns. Unfortunately, these changes may cause an increase in crash rates unless accompanied by good transitions to the new traffic controls. A transitional procedure informs drivers that traffic control will or has already changed before they arrive at the site of the new control, which should modify the driver's expectancy thereby reducing conflicts and crashes.

Pages [2-54](#) through [2-55](#) provide recommended procedures to insure a safe transition from one type of traffic control to another.

In addition to the static signs, it is acceptable to use portable changeable message signs (PCMS) to notify drivers of operational changes.

### Reversing STOP Signs

- Step 1 Create a four-way stop situation for a period of 30 days. During this 30-day period, Stop Ahead (W3-1) signs should be erected on the previously uncontrolled approaches, and a 4-WAY (R1-3) or ALL WAY (R1-4) supplemental plaque should be added below each R1-1 signs. A Type B flashing light with a red lens may also be placed above the new R1-1 signs.
- Step 2 After the 30-day period, on the approaches which originally had the STOP signs, remove the STOP (R1-1) signs, 4-WAY (R1-3) or ALL WAY (R1-4) supplemental plaques, any Stop Ahead (W3-1) signs, and any stop lines. On the other two approaches, replace the 4-WAY (R1-3) or ALL WAY (R1-4) supplemental plaques with CROSS TRAFFIC DOES NOT STOP (R1-1C) signs.
- Step 3 At least 60 days after the removal of the original STOP Signs, remove the CROSS TRAFFIC DOES NOT STOP (R1-1C) signs, the flashing lights, and if not warranted, the Stop Ahead (W3-1) signs.

### Four-Way to Two-Way Stop Control

- Step 1 Remove the ALL WAY (R1-43P) supplemental plaques, any Stop Ahead (W3-1) signs, and any stop lines on the approach which originally had the STOP (R1-1) signs. On the other two approaches, replace the ALL WAY (R1-43P) supplemental plaques with STOP SIGN REMOVED FROM SIDE STREET (R1-4-1) signs. A Type B flashing light with a red lens may be placed above the two remaining R1-1 signs.
- Step 2 At least 60 days after the removal of the two R1-1 signs, remove the STOP SIGN REMOVED FROM SIDE STREET (R1-4-1) signs, the flashing lights, and if not warranted, remove the Stop Ahead (W3-1) signs.

### One-Way to Two-Way Street Operation

- Step 1 Notify the general public by news media and abutting residences and/or businesses by direct mail about 30 days prior to the effective date.
- Step 2 Provide adequate sight distance at all intersections and driveways by removing parking, clearing vegetation, etc. Prohibit parking on the left side of the one-way street.
- Step 3 Install and cover Two-Way Traffic (W6-3) signs on both sides of the existing one-way street at its beginning and immediately beyond all intersections where major left turning movements occur. Also, install and cover Two-Way Traffic (W6-3) signs on all major approaches to the existing one-way street, but rotated 90 degrees to graphically depict traffic going both left to right and right to left.
- Step 4 Eradicate any pavement markings on the one-way street or side street approaches which will be in conflict with the new two-way operation. Install centerlines on the "one-way" street.
- Step 5 On the agreed upon date, uncover the Two-Way Traffic (W6-3) signs, and remove any non-applicable One-Way signs, BEGIN ONE-WAY (R6-12) signs or turn restriction signs. Install appropriate pavement marking arrows as appropriate.
- Step 6 At least 3 months after the conversion, remove the Two-Way Traffic (W6-3) signs.



### Two-Way to One-Way Street Operation

- Step 1 Notify the general public by news media and abutting residences and/or businesses by direct mail about 30 days prior to the effective date.
- Step 2 Install DO NOT ENTER (R5-1), WRONG WAY (R5-1A), and No Right/Left Turn signs, as appropriate.
- Step 3 Block off the unused lane(s) with drums or barricades.
- Step 4 Revise existing pavement markings to show new one-way direction, both on the affected street and on all side road approaches.
- Step 5 Remove drums or barricades.
- Step 6 At least 60 days after the conversion, remove any unwarranted DO NOT ENTER (R5-1), WRONG WAY (R5-1A), or No Right/Left Turn signs.

### One-Way Street Reversal

- Step 1 Notify the general public by news media and abutting residences and/or businesses by direct mail about 30 days prior to the effective date.
- Step 2 Provide adequate sight distance at all intersections and driveways by removing parking, clearing vegetation, etc. Prohibit parking on the left side of one-way streets.
- Step 3 Replace One-Way Signs with new signs showing appropriate direction. Install flags or flashing lights on the signs, if appropriate.
- Step 4 Consider placing drums or barricades at cross streets and pavement markings to emphasize new turning directions.
- Step 5 At least 60 days after the conversion, remove drums, barricades, and flashing lights.

### Revised Exit Numbers

In 2001, the Department changed from the consecutive exit-numbering system to the milepost exit-numbering system. If any of the "OLD EXIT ###" signs still exist, the District Traffic Unit should provide notification to the County Maintenance District to remove the signs when other maintenance work is being performed in the area.

If it is necessary to change exit numbers, Districts are encouraged to use the following steps, similar to the approach used on the statewide program:

- Step 1 Working through the District CRC and Office of Communications, notify the general public by the news media and abutting businesses by direct mail about 1 year and again about 30 days prior to the effective date, so that the residents and businesses can make necessary changes in directions, business cards, yellow pages, etc. If possible, schedule the effective date to coincide with the issuance of the new telephone directory.
- Step 2 Revise the exit numbers, and add a panel to each major advance guide sign with the message "OLD EXIT XX."
- Step 3 After a predetermined amount of time (2 years minimum) following the conversion, the panels with the old exit number may be removed as part of routine maintenance.



## 2.10 Miscellaneous Signs

### Anti-Littering Signs

The following five signs help to remind motorists not to litter:

<u>Sign</u>	<u>Size</u>
Keep Pennsylvania Beautiful (I14-1)	48"x30"
Keep PA Beautiful Symbol (I14-2)	30"x30", 36"x36"
Keep Pennsylvania Beautiful State Outline (I14-3)	48"x30"
Litter Fine (I14-4)	30"x24"
No Dumping Allowed (I14-5)	24"x18"

Only use Anti-Littering signs if their location will not interfere with the proper functioning of other necessary traffic control devices. Do not install these signs along sections of highway that have already been adopted under the Department's Adopt-A-Highway Program, but existing anti-littering signs may remain in place for their useful life along sections of highway that are later adopted.

The I14-1, I14-2, I14-3, and I14-4 signs can be used interchangeably for most situations. When a relatively lengthy, continuous section of highway has experienced recurrent littering, it may be desirable to post an I14-1, I14-2, or I14-3 sign followed by I14-4 signs. Following are recommendations regarding the use of anti-littering signs:

<u>Sign</u>	<u>Comments</u>
I14-1	Normally, this type of anti-littering sign is used on select on-ramps for public education purposes.
I14-2	The circular logo on this sign is consistent with the logo used for all anti-litter programs. Normally, the I14-2 sign is used along exit ramps into (entrances to) welcome centers, parking areas, rest areas, and scenic views.
I14-3	Normally, this is the first type of sign used on conventional road entry points to the Commonwealth.
I14-4	This sign is suggested for use at specific sites where littering has been a recurring problem. The sign is also suggested for entrance ramps from welcome centers, rest areas, parking areas, and scenic views to the mainline roadway.
I14-5	This sign may be used at locations that have recurring illegal dumping of heavy volumes of litter, garbage, or other waste material. Typical placement sites may include areas of excess right-of-way, graded ground adjoining a highway, and pull-off locations in remote areas.

### Coffee Break Signs

The Department allows safety-conscious local civic organizations to offer free coffee to motorists using rest areas during specific periods such as holiday weekends. Because these activities encourage the weary motorist to stop and relax, this activity is in the best interest of highway safety.

The organization must agree in writing to offer free coffee and to indemnify and save harmless the Commonwealth and PennDOT employees, from all suits, actions and claims. Because commercial activities are prohibited in rest areas, the organization must also agree to post a sign with minimum 6-inch letters stating NO DONATIONS, and to leave the area in similar or better condition than it was prior to the coffee break.

When a “coffee break” is approved, the county should erect a SAFETY BREAK FREE COFFEE (I98-1) sign. The last line on the sign should be NEXT RIGHT or other appropriate message. The sign should be placed a minimum of 300 to 500 feet before the Rest Area Directional Sign, and should be removed, folded or covered when free coffee is not being offered.

### Historical Markers

Concrete monuments and cast aluminum historical markers are the responsibility of the Pennsylvania Historical and Museum Commission. If these markers are in need of repair, the following office should be contacted:

Historical Marker Program  
Division of History  
Pennsylvania Historical and Museum Commission  
Commonwealth Keystone Building, Plaza Level  
400 North Street  
Harrisburg, PA 17120-0053  
[PHMC Historical Marker Program](#)

On the other hand, the cast iron historical markers for towns or rivers were installed by the Department. The Engineering Districts are encouraged to enter into agreements with local civic groups to maintain these markers. If the markers are not protected by guide rail or bridge abutments, or as a minimum non-mountable curbs in urban areas, the markers should be relocated or stockpiled for potential future use. Erect any new or refurbished installations on breakaway supports.

### Library Signs

On State highways, libraries are responsible for providing and erecting Library (I-8) signs after receiving authorization from the Department. When requested, the District Office shall approve appropriate locations on conventional State highways, directing motorists to public libraries from the nearest numbered traffic route or other major highway.

### Memorial Markers

The Department will only authorize or erect memorial markers on highways designated by the legislature and on Interstate highways Districts shall submit plan sheets to Central Office showing the sign’s proposed location(s), the location of existing signs and sign fabrication drawings for submission to FHWA. Authorization is contingent upon final approval and concurrence of FHWA. In order to manage this program, Central Office maintains a log of official named highways and bridges.

The following types of markers are available:

1. Bronze plaques may be locally procured in accordance with specifications available from Central Office. Common sizes are 15"x12" and 30"x24".

2. Non-Interstate memorial markers have white reflectorized legend and border on a green reflectorized background. Common sizes are 36"x12" and 48"x16", depending upon the speed limit and available space. The legend is typically 3" or 4" UC/LC. Signs may be ordered from the Sign Shop using material number 326716 for 36"x12" signs and 326717 for 48"x16" signs. These same material numbers are to be used for creating sign equipments in Plant Maintenance. A sample design detail is shown below in Exhibit 2-17.

**Exhibit 2-17 Sample Memorial Highway Sign Design**

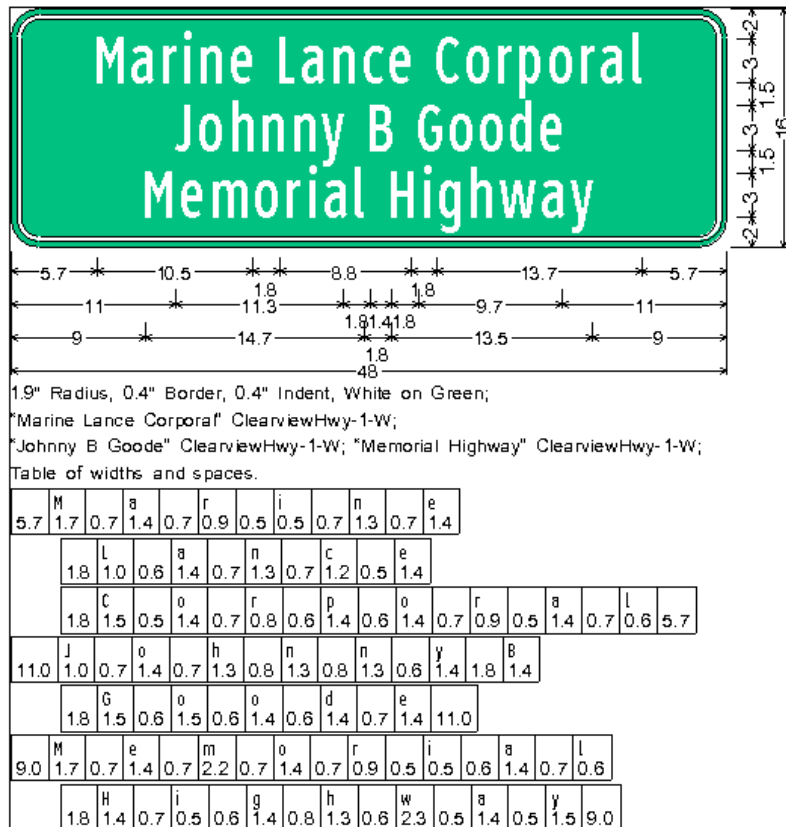

3. Interstate memorial markers have 8-inch upper/lower-case white reflectorized legend on a green reflectorized background. Before memorial markers may be erected on an Interstate Highway, FHWA must be obtained. When legislation designating signs be erected on the Interstate System, a copy of the sign fabrication detail and a plan sheet showing the proposed location and existing signs must be submitted to BOMO who will coordinate FHWA approval. Signs may be ordered from the Sign Shop using a D5 material number corresponding to the appropriate size.

Signs are normally mounted at the following locations:

- a) Memorial bridges should have either a bronze plaque or a memorial marker. Anti-theft nuts are recommended for all memorial markers.
- b) Non-Interstate memorial highways may have memorial markers facing traffic at the beginning of the designation and may also be installed at select locations along the highway.
- c) Interstate memorial highways may have memorial plaques or markers placed in rest areas, scenic overlooks or at other appropriate locations where parking is provided with the signing

inconspicuously located relative to vehicle operations along the highway. If installation of memorial markers off the mainline is not practical, the signing shall be limited to one memorial marker D5-series sign at an appropriate location in each route direction. If installed on the mainline highway, memorial signs must be independent of other guide and directional signing and not adversely compromise the safety or efficiency of traffic flow.

- d) Memorial interchanges may have memorial markers, a D5-series sign, installed on all non-Interstate approaches. Memorial signs must be independent of other guide and directional signing, and shall not adversely compromise the safety or efficiency of traffic flow, particularly with regard to entering or exiting traffic in the interchange area. Signs may be post-mounted or attached to the side of the overhead structure provided other guide signs are not already in place..

### Motorist Alert Signs

Motorist Alert (W23-series) signs may be erected prior to the start of a construction project as a courtesy to the motorist. A Type B warning light may be added to increase the sign's effectiveness.

General messages are included on the standard sign panels so that the signs may be reused on future projects. However, the messages on the W23-1 and W23-2 signs may be tailored to the particular project. With reference to the THIS BRIDGE TO BE CLOSED FOR MAINTENANCE (W23-1) sign, suggested overlay panels using 6-inch legend are as follows:

- 36"x8" **HIGHWAY** or **STREET** panel to cover "BRIDGE"
- 60"x8" **NEXT 3 MILES** panel to cover "THIS BRIDGE"
- 90"x8" **FOR CONSTRUCTION** or **FOR REPAIRS** panel to cover "FOR MAINTENANCE"
- 90"x8" **JUNE 28, 2007** panel to cover "NEXT WEEK"

The W23-series signs should generally be included as a special provision in applicable Department construction projects. It is desirable to stipulate that the signs become Department property at the end of the project, thus providing for their reuse.

### Municipal Name Signs

The Department will generally install 36"x12" municipal name signs (I10-series signs) on all State highways.

When requested by local authorities, the Department will fabricate and install oversized I10-series signs if the local authorities agree to pay for the signs. The cost of new or replacement oversized signs will be as noted below, plus a one-time \$100 administrative fee (one \$100 fee per request of one or more signs). These signs will generally have dimensions proportionally larger than the standard I10-series sign:

48"x16" For use on two-lane highways – \$400

72"x24" For use on multilane highways – \$500

On conventional roads and expressways, local authorities may install custom-made name signs as an alternative to the oversized I10-series signs after approval is granted by the appropriate Engineering District. Approval is contingent upon satisfying the following requirements:

1. Sign dimensions are as follows:

Type	Max. Width	Max. Area (Sq. Feet)	Max./Min. Legend Size
Highway			
Two-lane	48"	12	6"/2"
Multilane	72"	24	8"/3"

2. The primary message should be something like "Welcome to \_\_\_\_\_", with the municipality's name composed of the largest-size legend. A smaller-size supplemental slogan with up to six words may be added, e.g., "The White Rose City", "The Christmas City", etc., and/or a symbol may be used.
3. No lights, animation, directions, distances, names of officials, or advertising are permitted.
4. All signs shall be manufactured by a Department-approved sign manufacturer using approved Type III or IV retroreflective sheeting material, and installed in accordance with Publication 111.
5. The installation of special name signs may not be possible if insufficient space exists for the signs, or if the municipality changes too often within a short distance. (Existing traffic signs may be relocated at the municipality's expense in order to provide room for the oversize municipal signs.)

The District Executive has the authority to install or authorize the municipality to install the signs in accordance with these guidelines.

### Recreational and Cultural Interest Symbol Signs

Recreational and cultural interest area symbol signs for State or federal parks may be used on conventional roads that pass through or are immediately adjacent to a State or federal park. They may also be used inside these areas to direct tourists to non-vehicular services such as trails and rest rooms.

Symbols may be used as legend components of a directional sign assembly, but no more than four symbols shall be used on a single assembly. The following additional guidelines shall apply:

- Recreational and cultural interest area symbols shall have white legend on a brown rectangular background. Acceptable symbols are included in the "Guide Signs Chapter" of FHWA's *Standard Highway Signs and Markings* book.
- Educational plaques may be placed underneath symbol signs whose meaning is not readily obvious from the symbol graphic itself.
- When an activity is prohibited within a recreational or cultural interest area, a red diagonal slash may be placed on the symbol sign.

### Recycling Program Signs

The Recycling Services (I45-1) sign is designed for use within roadside rest areas to encourage the use of recycling services and to identify the group providing the services.

The Recycling Center Sign (I-11) may be used to direct motorists to permanent recycling collection centers from the nearest numbered traffic route or other major highway. The center must be open to the public and consistently take a minimum of three (Act 1988-101) materials. This sign shall not be used in urban areas or on freeways and expressways.

### Scenic River Signs

When a creek or river has been legislatively designated as a scenic river, scenic river signs may be installed along State highways when the river is clearly visible from the highway and the Pennsylvania Department of Conservation and Natural Resources (DCNR) requests the signs. Scenic river signs can be ordered from the Sign Shop (48"x24" D5-series) and installed on a reimbursable basis.

The following scenic rivers have been legislatively approved:

- Bear Run (Act No. 88-161)
- French Creek (Act 82-97)
- Lehigh River (Act 82-71)
- LeTort Spring Run (Act 88-42)
- Lick Run (Act 82-324)
- Lower Brandywine (Act 89-7)
- Octoraro Creek (Act 83-43)
- Pine Creek (Act 92-124)
- Schuylkill River (Act 78-33 & 88-17)
- Stony Creek (Act 80-18)
- Tucquan Creek (Act 88-161)
- Tulpehocken Creek (Act 92-118)
- Yellow Breeches Creek (Act 92-118)

In addition to Scenic River Signs along State highways, the Department has agreed to cooperate with DCNR in providing overpass road name signs on canoeable rivers. These signs would be similar to the overpass signs identified in Section [Overpass Roadway Identification Signs](#) on page [2-72](#), except a smaller size may be used on rivers less than 100 feet in width.

### Signs and Banners across State Highways

No person, municipality or corporate entity may place a sign or banner across a State highway or within the highway right-of-way, unless the local municipality has:

1. passed a resolution designating their intention to erect such a sign or banner, and
2. received confirmation from the Department that it has on file a copy of the resolution and all required issues have been adequately addressed.

Resolutions may be for a single event, an event that recurs on a regular basis, or multiple events throughout the year. Permanent cables across the right-of-way for erection of banners are permissible provided they are noted in the resolution. Any municipal sponsored sign or banner placed across a State highway without a resolution on file with the Department can be removed; however, the municipality should first be given the opportunity to pass a timely resolution. No sign or banner may be placed across or within the right-of-way of any limited access highway.

The Department will only consider resolutions that address the following:

- Installation location including SR, Segment/offset and vertical clearance above the roadway (minimum 17'-6").
- Size of the sign or banner, a description of the message, and the event(s) and/or organization(s) for which the banner is being erected. Events must relate to a national, state, regional or local function or charitable affair.
- Approximate date(s) of installation and removal. If the sign or banner is to be installed on a recurring basis, the occasions when it will be displayed and the approximate number of days before and after the occasion when the device will be installed and removed, respectively.
- That the municipality assumes full responsibility for erecting, maintaining and removing the device and all liability for damages occurring to any persons or property arising from any act of omission associated with the sign or banner.
- Acknowledgement that no more than 20-percent of the message will relate to naming or advertising a commercial product, enterprise, business or company regardless of whether they are sponsoring the event or banner installation.
- That traffic control will be performed in accordance with the current Publication 213.

### SR and Segment Markers

SR and Segment markers are valuable in determining field locations for highway maintenance and information-gathering activities. Therefore, the maintenance of these markers is very important.

Any Department employee who observes that a SR or Segment marker is missing or is installed at a questionable location or orientation, should contact the District RMS Coordinator, who in turn will advise the District Traffic Engineer or the Assistant District Traffic Engineer in charge of operations so that the changes can be made. However, under no circumstances should a county install or move a marker without an order from the District RMS Coordinator.

Information on missing and incorrect SR/Segment markers is also collected every year through the STAMPP and LRS QA/QC programs. A computer-generated listing, resulting from the LRS QA/QC, will go to the District RMS Coordinator, who will then work with the appropriate District people to make the changes in the field.

Fiberglass SR and Segment markers are available from contract Legacy No. 9905-13. When ordering the markers, use [Exhibit 2-18](#) so that all Districts are using the same forms.

As an alternative to purchasing completely finished markers, partially-finished SR and Segment markers may be ordered from the contract. Department personnel can affix the appropriate legend as required (see [Exhibit 2-5](#)). The Sign Shop can provide legend using the following SAP Material Nos.:



<u>SAP Material No.</u>	<u>Description</u>
144489	1.5" numerals for Segment markers
144490	3" numerals for SR markers
144491	4" numerals for Segment markers

### Street Name Signs

The 36"x8" Street Name Sign (D3-1) is the standard for this application. In addition, larger signs are authorized and encouraged. Overhead signs mounted on signal mast arms or span wire should have 12-inch upper/lower-case legend, except when engineering justification requires the use of smaller text.

In addition, it is very desirable to place black-on-yellow advance street name signs (D3-2 or D3-3) beneath all intersection warning signs on numbered traffic routes in rural areas (See the Section [Advance Street Name Signs](#) on page 2-22).

### Welcome to Pennsylvania Signs

Welcome to Pennsylvania Signs should be erected on all roadway approaches to the Commonwealth. The standard sizes are as follows:

- Interstate highways – 264"x144" – (I13-2)
- Non-Interstate freeways – 192"x108" – (I13-2)
- Major traffic routes on conventional roads – 144"x78" – (I13-2)
- Other conventional roads – 48"x24" and 72"x36" – (I13-2A)

### Wildflower Area Signs

The Wildflower Area Sign and plaque are designed to advise individuals that wildflowers have been planted and that picking or destroying the wildflowers is illegal. The signs may be procured from the Sign Shop, where they are specified as follows:

18"x24" Wildflower Area Sign, non-reflectORIZED

18"x12" Wildflower Regulation Plaque, non-reflectORIZED

**Exhibit 2-18 SR and Segment Markers Tabulation Sheet**





District \_\_\_\_\_

County \_\_\_\_\_

Segment Marker (10"x10")		
Qty.	SR No.	Seg. No.

SR Markers (18"x12")					
Qty.	1st Line	2nd Line		3rd Line	
	SR No.	Arrow*	Seg. No.	Arrow*	Seg. No.

Arrow Codes:

LH = , RH = , LD = , RD = , UA = 

\* Arrows to the right should be after the segment number.

## Object Markers

Information on Object Markers can be found in Section 3.3 on page 3-13.

## 2.11 Excessive Use of Signs

### Sign Clutter

The Districts are requested to regularly review existing signs to ensure that all of the signs are official and are necessary for regulatory, warning or guidance purposes. In addition to removing obsolete and unofficial signs, consider the following suggestions:

- a) Use 250-foot typical spacing between no parking signs in rural areas.
- b) Review the use of BUMP (W8-1), DIP (W8-2), Slippery When Wet (W8-5) and LOW SHOULDER (W8-9) signs to be sure that they are not left in place after the problem has been corrected.
- c) Eliminate the use of 55-mph Speed Limit Signs on non-freeways except when needed to indicate the end of a lower speed limit.
- d) Eliminate Stop Ahead (W3-1), Yield Ahead (W3-2) and Signal Ahead (W3-3) signs when the Stop (R1-1) or Yield (R1-2) sign, or the traffic signals are visible by approaching traffic for distances greater than those values noted in the justification for the advance warning sign unless there is a known crash problems. In addition, the "T" Symbol Sign (W2-4) should generally not be used on an approach which also has a Stop Ahead (W3-1) sign.
- e) Review the need for existing curve and turn signs.

### Double Stop Signs

The installation of one STOP (R1-1) sign on top of another is in conflict with Section 2B.04 of the *MUTCD*. Therefore, if this practice exists, the Engineering District should issue the necessary work order to have one of the R1-1 signs removed. Use a larger R1-1 sign if greater emphasis is needed.

If a municipality has any double stop sign installations, advise them in writing that this practice is in conflict with the *MUTCD* and that they should revise the installation.

### Sign Grouping

In an effort to improve the roadside environment and to eliminate unnecessary posts, sign grouping and back-to-back installations are encouraged wherever possible. Small relocations of most signs can generally be made without compromising the design standards. Refer to Section 5.1 of the Sign Foreman's Manual, Publication 108.

## 2.12 Standard Freeway and Expressway Signs

### Standards and Approvals

The types of signs unique to expressways and freeways are generally described in Publication 111.

FHWA approval is required for signing on all Interstate highways that does not comply with existing standards:

1. For Federal Oversight projects on the Interstate system, proposed signing is normally included in the PS&E.

2. For PennDOT Oversight projects on the Interstate system, proposed highway signing that does not comply to existing standards must be sent to the Central Office for submission to the FHWA Division Office. For this submission, include two copies of plan sheets and any sign fabrication details, along with information about the types of posts and breakaway hardware.

## Selection of Major Destinations

### General

These guidelines are for selecting the most appropriate destinations for major guide signs on expressways and freeways, in order to provide the driver the best orientation possible without overloading the driver with too much information.

### Definitions

*Destination* – The name of an incorporated community, street name, municipal center or large traffic generator, which provides the best orientation for drivers traveling on the expressway or freeway.

*Map* – The latest edition of the Department's Official Tourism & Transportation Map.

*National control city* – A city designated as such by the American Association of State Highway and Transportation Officials (AASHTO) for an Interstate highway. A list of appropriate cities is included in [Exhibit 2-19](#).

*Population-to-distance ratio* – The ratio of the population of a community identified on the map to the distance in miles from a given interchange.

*Urban area* – A built-up area which includes any of the following features for a given expressway or freeway:

- Four or more adjacent interchanges serving the same community.
- More than two travel lanes in each direction.
- Interchanges typically spaced at intervals of 3 miles or less.

**Exhibit 2-19 National Control Cities in or Adjacent to Pennsylvania**

Interstate	National Control Cities
70 EB	Washington, PA; New Stanton; Breezewood; Hancock
70 WB	Breezewood; Wheeling
76	Youngstown; Pittsburgh; Harrisburg; Valley Forge; Philadelphia
78	Harrisburg; Allentown; Bethlehem; Easton; New York City
79	Morgantown; Washington, PA; Pittsburgh; Erie
80	Youngstown; Sharon; Clarion; DuBois; Clearfield; Bellefonte; Williamsport; Bloomsburg; Hazleton; Stroudsburg; Delaware Water Gap, New York City
81	Hagerstown; Chambersburg; Carlisle; Harrisburg; Hazleton; Wilkes-Barre; Scranton; Binghamton
83	Baltimore; York; Harrisburg
84 EB	Milford; Port Jervis
84 WB	Scranton
90	Cleveland; Erie; Buffalo
95 NB	Wilmington; Chester; Philadelphia; Trenton
95 SB	Philadelphia, Chester, Wilmington

**Criteria for Selecting Major Destinations**

Junction with an Interstate Highway. If the intersecting route is an Interstate highway, the closest national control city to the left and to the right should be used as the destinations on the major guide signs. A list of national control cities in or adjacent to Pennsylvania is included in [Exhibit 2-19](#).

Interchange with an Expressway or Non-Interstate Freeway. If the intersecting route is an expressway or a non-Interstate freeway, the first major city, borough or municipal center identified on the map in each direction along the intersecting route should be used as the destinations on the major guide signs. Each destination should generally have a population of at least 10,000 people and be within 20 miles in urban areas, and within 50 miles in rural areas. Municipal centers should have a concentrated center, but need not be an incorporated municipality.

Non-Urban Areas – Interchange with a conventional road. In non-urban areas at interchanges with conventional roads, an effort should be made to have a destination to the left and to the right on the major guide signs.

1. If the intersecting highway is a U.S. or PA traffic route, the destinations should generally be the closest city, borough, village or home-rule municipality to the left and to the right as identified on the map. If a more distant community exists along the traffic route having a population-to-distance ratio at least 50 percent greater than any closer community identified on the map, the more distant community name may be used in lieu of the closer community name providing the more distant community:

- is not directly linked to another interchange along the traveled route within the next 25 miles; and
  - is within 15 miles if it has a population less than 10,000 or within 20 miles if it has a population greater than 10,000.
2. If the intersecting route is not a numbered traffic route, the destinations should generally be the closest city, borough, village or home-rule municipality to the left and to the right, on or immediately adjacent to the crossing highway as identified on the map. If a more distant community exists on or immediately adjacent to the crossing route that has a population-to-distance ratio at least 50-percent greater than any closer community, the more distant community name may be used in lieu of the closer community name providing the more distant community is shown on the map and is within 5 miles, or within 10 miles if it has a population over 5,000.
  3. If at least one destination cannot be selected which satisfies the criteria in paragraphs (1) or (2), a “point location” which is not shown on the map (for example, a village) may be used.

Urban Areas – Interchange with Conventional roads. In urban areas at interchanges with conventional roads, street names or municipal center names should generally be used instead of community names, after receiving written concurrence of the local authorities. In addition, a Community Next (\_\_\_) Exits sign and Interchange Sequence signs should generally be used in urban areas.

### Special Signing

Trailblazing. Consider trailblazing to traffic routes near the interchange by providing the traffic route shield and the “TO” supplemental message.

Large Non-Municipal Traffic Generators. Bridge and freeway names are effective destinations to provide orientation for drivers, especially in large metropolitan areas. In addition, it is permissible to use the name of a large traffic generator as the destination if the crossing roadway essentially only serves the traffic generator; examples of large traffic generators include airports, national and State parks, industrial parks, etc.

Multiple Signs. Where two or more guide signs are on the same structure, it is desirable to limit destination names to one per sign, or to a total of three in any direction of travel.

Design Considerations. The field location and layout details of the guide signs should be in conformance with Traffic Standards 8701A and 8701D (Publication 111) respectively.

Municipal Name Signs. Signs to identify the municipal boundaries may be installed in accordance with the section [Municipal Name Signs](#) on page [2-59](#).

### Selection of Supplemental Destinations

Information regarding destinations accessible from an interchange other than the destinations on the major guide signs may be listed as:

1. An attraction on Logo Signs (refer to Section [2.14](#)), or
2. A destination on a Supplemental Guide sign if determined to be appropriate by the Department.

Because Supplemental Guide Signs can only accommodate two destinations, the preferred method is also to use Logo Signs, whenever possible. However, if a destination is not eligible for logo signs under Section [2.14](#), it may be eligible for inclusion on a Supplemental Guide Sign. The *MUTCD* and the *AASHTO Guidelines*

for the Selection of Supplemental Guide Signs for Traffic Generators Adjacent to Freeways provide details for supplemental guide signs.

**Motorist Service Signs**

Motorist Service Signs are generally installed only on freeways. Two specific types are available: (1) General Motorist Service Signs (Section 2.13), and (2) Logo Signs (Section 2.14).

Logo signs are now installed on most Interstate highways and freeways by the Pennsylvania Tourism Signing Trust. Therefore, the counties and Districts should not expend unnecessary monies to replace general motorist service signs on Interstate highways unless it is known that logo signs will not be installed at the interchange.

**Reference Location and Enhanced Reference Location Signs**

Signs shall be erected on all Interstate highways showing the mileage along the route with increasing order in the same direction as increasing interchange numbering. Historically, these signs were called “mile markers” or “distance markers,” but they are now referred to as “reference location signs.” These signs should be installed in accordance with the procedures identified in Publication 111.

There are three types of “reference location signs” that may be used, but the third type is required and only to be used on sections of highway where Intermediate Reference Location (D10-1a, D10-2a or D10-3a) signs are used at 1/10<sup>th</sup> or 2/10<sup>th</sup>-mile intervals as discussed in the Section, [Intermediate Reference Location Signs](#) on page 2-70:



**Exhibit 2-20 Versions of Reference Location Signs**

Version	Nomenclature	Description
1	D10-1, D10-2, D10-3	Reference Location Sign
2	D10-1a, D10-2a, D10-3a	Intermediate Reference Location Signs
3	D10-5	Enhanced Reference Location Sign



Mileage on circumferential freeways shall increase in a clockwise direction, beginning with Mileage 0 (i.e., MP 0) with the first interchange west of a radial freeway or other Interstate route or some other conspicuous landmark in the circumferential route near a south polar location.

Mileage on spur routes should begin with Mileage 0 at the junction with the main line of the principal route. If the spur route connects two different main line routes, the principal route is the one with the same last two digits in the route number and the spur. For example, I-283 connects both I-76 and I-83, but I-83 is the principal route.

Where numbered freeways overlap, continuity of the mileage shall be established for the RMS priority route only.

When a District elects to install D10-1, D10-2, D10-3 D10-4, or D10-5 signs at 1-mile intervals on non-interstate freeways, the procedures outlined below will be followed for their installation.

- a) Only full limited-access highways will be considered.
- b) Mileage on the signs will increase south-to-north and west-to-east, consistent with the existing RMS system. Mileage 0 (MP 0) will begin at the southern or western state line respectively, or at the beginning of the numbered traffic route. Determine subsequent distances by traveling the route with a distance-measuring instrument (DMI) and marking locations on the shoulder. At the same time, verify the segment/offset for subsequent entry into the RMS database.
- c) Compute distances consecutively, consistent with RMS, regardless of missing sections of limited-access highway. For example, US 15 begins at the Maryland line (MP 0) and increases for a distance of 22 miles before the limited-access portion of the highway terminates. About 15 miles farther, another limited-access portion of US 15 begins with the posting of Distance Marker MP 37.
- d) The presence of county lines will have no consequence on the mileage determination just as in the case of the Interstate System.
- e) In situations where traffic routes overlap, the standard RMS convention for assigning priority will apply, and the mileage for the priority route will be continuous on the D10-1, D10-2, D10-3 or D10-4 signs. When routes subsequently separate, base distances on each route having carried the distances continuously. For example, where US 22 and US 322 overlap, the signs will carry the mileage based on US 22. Once the routes separate, US 322 will pick-up the mileage as if it had been continuously carried through the overlapped section.
- f) Prior to the installation of any D10-1, D10-2, D10-3 or D10-4 signs, each sign must be identified on the "RMS Mile Marker Screen" accessed through the 406-Menu Screen (#21) or through the Jump Screen (#20). The District must identify each proposed sign location by county/SR/segment/offset and enter them in RMS. Note that the segments and offsets will not be modified to correspond with the mileage, as is the case with the Interstate System.
- g) When changes in alignment (e.g., construction of new limited-access highway, reconstruction of existing conventional road, etc.) result in recalibration of RMS distances contiguous to the section of highway where D10-1, D10-2, D10-3 or D10-4 signs are installed, the signs will be relocated to correspond with the new RMS stationing. These revised locations must be input in RMS as discussed in paragraph f above. Note that when realignments occur on non-freeway sections that result in actual mileage changes of the route, but do not affect the section of highway where D10-1, D10-2, D10-3 or D10-4 signs are installed, it is not required that the sign be relocated.

**Intermediate Reference Location Signs**

To assist in locating incidents, the Department has adopted the Intermediate Reference Location (D10-1a, D10-2a, and D10-3a) signs as identified in Section 2H.06 of the *MUTCD*.

Department policy for Intermediate Reference Location (D10-1a, D10-2a, and D10-3a) signs is as follows:

- 1. It will be up to each Engineering District to determine when and where to install the D10-1a, D10-2a, and D10-3a signs; however, all initial installations shall be by contract.
- 2. The D10-1a, D10-2a and D10-3a signs shall only be installed on freeways and full limited-access portions of expressways where Enhanced Reference Location with Decimal (D10-5) signs currently

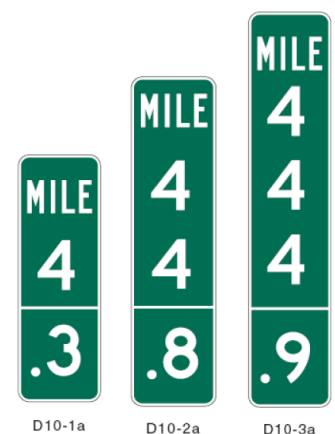



exist or will be installed concurrently with the D10-1a, D10-2a and D10-3a signs. (This may require replacing the existing D10-1, D10-2 and D10-3 signs.)

3. Avoid installing D10-1a, D10-2a and D10-3a signs for short distances (i.e., less than 5 miles) or intermittently. Always use logical termini.
4. Intermediate Reference Location (D10-1a, D10-2a and D10-3a) signs will be installed at 2/10<sup>th</sup>-mile intervals (i.e., even-numbered tenths) except as follows:
  - a. Use 1/10<sup>th</sup>-mile intervals in urban areas where AADT exceeds 75,000 or the interchange spacing averages less than 1.5 miles
  - b. Use 1/10<sup>th</sup>-mile intervals for crest vertical curves in excess of 1,000 feet where the rate of vertical curvature (K), as defined in the AASHTO Policy of Geometric Design of Streets and Highways, exceeds 380.
  - c. Use 1/10<sup>th</sup>-mile intervals on horizontal curves where the sight distance is less than 1,000 feet and the D10-1a, D10-2a and D10-3a signs are mounted on the same side of the highway as the direction of the curve.
5. Install all D10-1a, D10-2a and D10-3a signs in accordance with TC-8710. Consider mounting the D10-1a, D10-2a and D10-3a signs back-to-back in the median when the median width is 30 feet or less. Otherwise, install them along the right edge of the highway.
6. When traffic routes overlap, use the standard RMS convention to assign priority.
7. For non-interstate freeways, the District must identify each proposed D10-1a, D10-2a and D10-3a sign by county/SR/segment/offset, and ensure that they are in RMS before the physical installation begins. To enter the data, access the "RMS Mile Marker Screen" through the 406-Menu Screen (#21) or through the Jump Screen (#20). Note that the segments and offsets will not be modified to correspond with the mileage as is the case with Interstate highways.
8. Deployment of D10-1a, D10-2a and D10-3a signs will include the distribution of mapping to local first responders and emergency management officials.

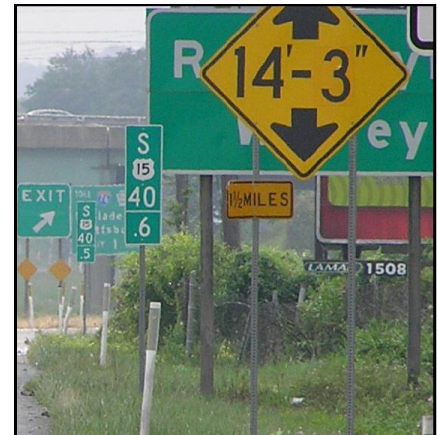

### Interchange Numbering

Interchange numbering provides valuable orientation for motorists and is required on all Interstate highways. When used, interchange numbering shall be mileage-based, and conform to the mileage of the nearest Reference Location or Enhanced Reference Location signs as discussed in the Section [Reference Location and Enhanced Reference Location Signs](#) on page 2-69. Junctions with other freeways, including other Interstate highways shall be numbered.

On multi-exit interchanges, such as a cloverleaf interchange, use the suffix letters A or B. In the direction of increasing interchange numbering, the first exit shall use the suffix A and the second exit shall use the suffix B. In the opposite direction, the exits shall typically be given the suffixes in the opposite order so that both Exit A's go toward the same destination, and both Exit B's go toward the same destination.

If it is necessary to revise exit numbers, use the transitional signing procedure identified in the Section [Revised Exit Numbers](#) on page 2-55.

### Overhead Signs

Luminaires are not required on new overhead sign installations when a minimum 800-foot tangent sight distance exists in advance of the sign and the vertical alignment allows headlights to illuminate the sign. Districts may also disconnect existing luminaires on signs with minimum Type VIII or IX reflective backgrounds when the necessary sight distance exists.

Overhead sign structures shall not be left without any signs on the superstructure, since signs are necessary for vibration-dampening purposes.

### Upgrading Temporary Signs

Publication 111 specifies the appropriate legend size for all common expressway and freeway signing. All signs with legend smaller than the specified size are considered temporary. Sections of Interstate highways with temporary signs are eligible for Interstate funding for sign replacement.

### Overpass Roadway Identification Signs

The installation of Overhead Roadway Identification (I18-1) signs are encouraged on expressways and freeways to identify the numbered traffic route or local name of the roadway on the overpass bridges.

Center all I18-1 signs over the roadway approach, mounted flush to and at the same grade as the parapet on the overpass. Avoid mounting signs over expansion joints.

### Public Relations

When the Department proposes to change signing that may cause street address or directional differences, such as changing exit numbers, exit suffixes, destination names, etc., it is imperative that adequate advance public relations be conducted with local authorities and other community organizations. The notification should be as far in advance as possible, with follow-up information as the event nears.

## 2.13 General Motorist Service Signs

### Purpose and Authorization

This policy establishes uniform guidelines for the approval, design, installation and replacement of general motorist service signs for gas, food, diesel, lodging, information, camping, hospital and State police, on freeways and locations between the freeway and the motorist service. Since logo signs (Section 2.14) are anticipated for most Interstate highways, extensive changes in current general motorist service signs are not desirable except on those Interstate highways where logo signs cannot be installed.

The final authorization of signs and the selection of sign locations will rest with the Department. When the signs are to be installed on an Interstate highway, the Department's authorization is contingent upon approval of the Federal Highway Administration if the signing is not in conformance with Publication 111. The authorization of signs should not be construed to be an endorsement of the facility or the services offered, but only means that the minimum standards and criteria are satisfied.

### Definitions

*Motorist service* – A gas, food, diesel, lodging, camping, information, hospital or State Police service as identified in the Section [Acceptable Types of Motorist Services](#) on page 2-73.

*Motorist service directional sign* – A sign on off-ramps and on conventional roads, which displays one or more motorist service symbols or legends and a one-way or two-way directional arrow.

*Motorist service panel* – A sign along a freeway displaying one or more motorist service symbols or legends and the appropriate legend “NEXT RIGHT” or “SECOND RIGHT.”

*Motorist service symbol* – Any of the eight symbols identified in [Exhibit 2-21](#).

**Exhibit 2-21 Motorist Service Symbols**

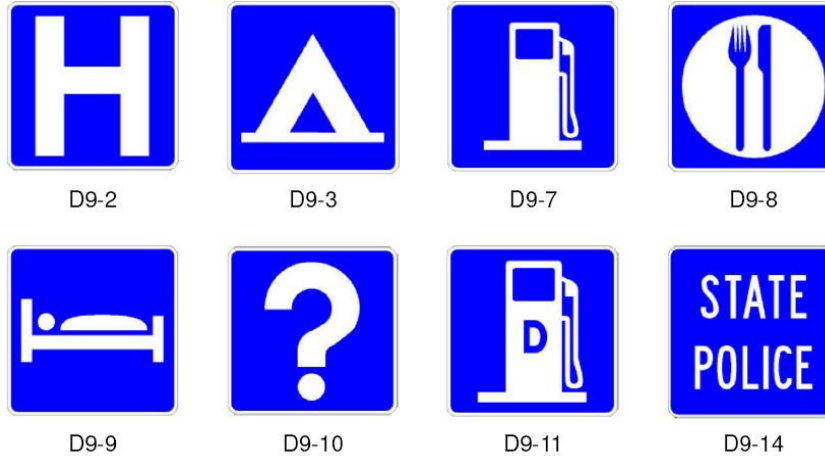

**Acceptable Types of Motorist Services**

1. Camping. A campground licensed by the Department of Environmental Protection (DEP) with continuous operation for at least 6 months each year; accommodations for a minimum of 20 campers; an attendant available during the normal working hours; rest rooms with showers, running water and flush toilets; laundry facilities; and a public telephone. Accommodations sold on a time sharing basis or otherwise not available for general public use will not be considered toward the minimum requirements (Section 2.7 allows personalized attraction signs on non-freeway facilities, and Section 2.14 provides for logo signs on select Interstate highways.)
2. Food. A restaurant with a license issued by the Department of Health; seating for at least 20 people; continuous operation for at least 11 consecutive hours, 7 days a week; public rest rooms with sink, running water and flush toilet; and a public telephone.
3. Gas or Diesel. A station with gasoline or gasoline and diesel fuel; water for radiators; rest room with sink, running water and flush toilet; continuous operation for at least 16 hours per day, 7 days per week; and a public telephone.
4. Hospital. A facility with approval as a hospital by the Department of Health; and continuous emergency care capability to the general public with a doctor on duty 24 hours a day, 7 days a week.
5. Information. An establishment with approval by the Department of Commerce as a tourist or visitor information center; an open season of at least 6 months each year; open at least 10 hours per day, 7 days per week between Memorial Day and Labor Day, and at least 8 hours per day, 7 days a week during the balance of the open season; an attendant on duty during all open hours; and free access to rest rooms, drinking water and telephone service.

6. Lodging. A hotel or motel with adequate sleeping accommodations and off-street parking for at least 20 private rooms with private baths; continuous year-round operation 24 hours a day, 7 days a week; and a public telephone.
7. State Police Station. A station manned by State Police 24 hours a day, 7 days a week.

### Additional Criteria

- a) Laws and Regulations. All motorist service facilities shall conform to all applicable Federal, State and local laws or regulations, and be open to all persons regardless of race, color, religion, ancestry, national origin sex, age or handicap.
- b) Distance from Freeway. The services shall be within the following distances from the ramp terminus and the crossing route:
  - Gas and diesel – 1.0 mile, except the maximum distance for “gas” may be increased up to a total of 2.0 miles if the average distance to adjacent interchanges is more than 6 miles.
  - Food, lodging, and information – 2.0 miles, except the maximum distance for “food” may be increased up to a total of 3.0 miles if the average distance to adjacent interchanges is more than 6 miles.
  - Hospitals and State Police stations – 3.0 miles. (5.0 miles for Hospitals in rural areas.)
  - Camping – 3.0 to 15.0 miles. If camping services are not available within the 3.0-mile limit, the limit may be extended up to 15.0 miles in increments of 3 miles until there are participants.
- c) Urban Areas. Only Information, Hospital and State Police services will be signed at interchanges within the corporate boundaries of a city, or an area which appears as an urban or metropolitan area.
- d) Continued Travel. Signs will not be authorized where a U-turn or illegal movement is required or at locations where motorists cannot conveniently return to the freeway for continuation of travel in the same direction. Signs will not be authorized at interchanges with freeways.

### Sign Location

Motorist service panel. When motorist service panels are installed on freeways, they should be erected following the first major guide sign and, if possible, following any supplemental guide sign. A minimum 800-foot spacing will be maintained between this sign and any large guide sign.

Freeway off-ramp. A Motorist Service Directional Sign will be erected on freeway off-ramps if exiting traffic can turn in both directions on the crossing route and the motorist service is not readily visible to approaching motorists.

Conventional road. Except for camping and information services, Motorist Service Directional Signs may be installed along the crossing route and at subsequent locations to indicate directional changes for motorists traveling from the freeway. The distance to the service may also be indicated if the service is not within the immediate interchange area. (Legend-type signs with the campground or visitor center's name may be authorized at the service's expense along the crossing route and at subsequent locations in accordance with Section 2.7.) In addition to trailblazing from freeways, signs may also be installed along conventional roads for State police stations and hospitals, directing motorists from the nearest numbered traffic route or other

major highway, providing the maximum distance does not exceed the appropriate base mileage identified in the Section [Additional Criteria](#) on page [2-74](#).

Local roadways. If signs are required on local roadways (municipal streets or roads) in order to trailblaze motorists from a State highway to the service, the installations shall be coordinated to ensure signing continuity.

Insufficient space. If insufficient space is available for motorist service signs, do not authorize any Motorist Service Signs will be authorized.

### **Design of New Installations**

Motorist Service Panels and Motorist Service Directional Signs will be designed in accordance with Publication 111. In urban areas (where motorist service panels are not installed) the Department may install "Information," "Hospital," or "State Police" motorist service symbols beneath the last advance major guide sign (the last sign with a distance to the off-ramp included on the sign) before the off-ramp. When only one motorist service symbol is warranted prior to an interchange and a motorist service panel does not exist, the appropriate symbol may be installed beneath the last advance major guide sign prior to the off-ramp. (All signs installed beneath major guide sign shall either be attached only to one of the posts or shall be attached to the major guide sign, so as to avoid interfering with any breakaway hinge.)

### **Procedures for Application**

The Department will review the motorist services when a roadway is being "resigned," and may have signs erected for applicable motorist services.

Requests for service signing may be submitted to the Department at any time. The application ([Exhibit 2-22](#)) should be returned to the appropriate Engineering District Office. The Department will assume all costs associated with the erection of general motorist service signs.

**Exhibit 2-22 Application for General Motorist Signs**

Instructions:

- i. Read **Section 2.13** in its totality.
- ii. Complete the questions at the bottom of this sheet.
- iii. Send the application to the appropriate Engineering District Office. (The District Office will review the application, determine if the facility qualifies for motorist service signing, and respond to you.)

1. Circle type(s) of Service:

Gas	Food	Lodging	Diesel
Camping	Hospital	Information	State Police

2. Business name and address \_\_\_\_\_  
 \_\_\_\_\_  
 \_\_\_\_\_ Telephone No. \_\_\_\_\_

3. Direction from the interchange . \_\_\_\_\_  
 Distance from the interchange. \_\_\_\_\_

4. Locations of proposed motorist service signs: Route, Intersecting Route, Interchange name and number: \_\_\_\_\_  
 \_\_\_\_\_

5. Applicant's name and address . \_\_\_\_\_  
 \_\_\_\_\_  
 \_\_\_\_\_ Telephone No. \_\_\_\_\_

6. I certify that the requirements of the Section **Acceptable Types of Motorist Services** (page 2-73 of Publication 46) and the Section **Additional Criteria** (page 2-74 of Publication 46) are satisfied, and I agree to immediately advise the Department of any changes that the business does that relate to these requirements.

\_\_\_\_\_  
 Signature

## 2.14 Logo Program

### Purpose

The logo program is a traveler information service provided for motorists that travel Pennsylvania highways. Moreover, since “logo” signing is authorized as a public service, only those services and facilities that are reasonably accessible at interchanges will be signed.

Therefore, the purpose of this subchapter is to establish guidelines for the approval, design, erection, maintenance and funding of logo signing along Interstate highways and other freeways for gas, food, lodging, camping services, and general attraction destinations.

### Authority

These guidelines are in accordance with standards issued by the Federal Highway Administration under authority of Title 23, U.S. Code Sections 109(d), 131(f) and 315, the Manual on Uniform Traffic Control Devices, 49 CFR 1.48(b), and Title 75 Pa.C.S. § 6122. Where differences occur between these guidelines and the national standards, the more restrictive shall govern.

### Administration

The program is currently administered by the Pennsylvania Tourism Signing Trust whose duties and responsibilities are defined in the Section [Duties of a Logo Signing Trust](#) on page 2-95. All signs become the property of the Department after they are erected. Additional information is available at [www.palogo.org](http://www.palogo.org).

### Definitions

*Attraction* – A facility that is of interest to and destination for motorists and is eligible for participation in the logo program, herein referred to as a business or service.

*Freeway* – A highway to which the only means of ingress and egress is by interchange ramps.

*General public* – The people of society who are not members of a particular organization or who do not belong to a particular group.

*Logo Panel* – A sign provided by the business or attraction to identify the business’s trademark or name. The Logo Panel is attached to the Sign Panel, Ramp Sign or Trailblazer.

*Ramp sign* – A small sign panel erected along an off-ramp to direct motorists to a particular service. (See [Exhibit 2-28](#))

*Sign panel* – The main part or backpanel of a specific service sign to which individual logo panels are attached.

*Specific Service Sign* – A guide sign that provides business identification and directional information for services and for eligible attractions along limited-access highways. Eligible service categories shall be limited to gas, food, lodging, camping and attractions. (See [Exhibit 2-24](#), [Exhibit 2-25](#), and [Exhibit 2-26](#).)

*Tourist Oriented Directional Sign (TODS)* – A 72”x24” or 48”x16” directional sign (D7-4) with white legend on blue or brown background that indicates the name of, and gives directional guidance to the attraction. These signs are located for individual Participant(s) and serve as trailblazers for attraction participants.

Trailblazer – A small sign panel similar to a ramp sign (or D7-4 TODS-type sign for attractions) that is erected on the road network accessed by way of a logo-signed interchange to direct motorists to a particular service.

### Types of Services

Services are limited to gas, food, lodging, camping, and attractions. To qualify, services shall be open to the public regardless of their race, religion, color, sex or national origin. They shall have paved driveway entrances which are properly permitted by the Department or municipality, as applicable, except campground and attraction entrances for fairgrounds; recreational areas; state and national parks, forest or cemetery, or state game lands; and unique natural areas may be unpaved. Each facility shall have adequate on-premise signing which is clearly visible to approaching motorists and identifies the service location, and shall satisfy the following:

- a) Gas. A station for cars or trucks, which provides any one of gasoline, diesel, CNG, LPG, LNG, electric (must be Level 3 minimum) or other alternative fuel. There must also be available at the station oil and free public rest rooms with sinks and running water. The station shall be in continuous operation for at least 16 hours per day, 7 days a week. A telephone on or within 500 feet of the property shall be available during hours of operation. Any facility that qualifies for participation under the gas service that does not sell gasoline must include supplemental messages of the alternative fuels provided followed by the word "ONLY".
- b) Food. A restaurant which is licensed by the Department of Agriculture or local health jurisdiction, accessible without an admission fee, and provides seating for at least 20 people within the same building, in continuous operation for at least 10 hours per day, 6 days a week, and contains public rest rooms with sinks and running water. Restaurants within shopping centers will not qualify unless they have an outside entrance directly accessing the restaurant's leased space, which is clearly labeled and readily visible and accessible to approaching motorists. Restaurants only open 6 days a week must include a supplemental message on their logo panel stating the day they are closed.
- c) Lodging. A hotel or motel with private rooms and baths, public telephones or telephones provided in each room, adequate off-street parking, and available 24 hours a day, 7 days a week. Condominiums and time-share forms of hotel occupancy may participate, provided they are marketed to the General Public for overnight accommodations.
- d) Camping. A campground with continuous operation for at least 6 months per year and a minimum of 20 overnight sites. An attendant shall be available during the hours of operations and rest rooms with showers, running water and flush toilets shall be available. A public telephone also shall be available on the site or within 500 feet of the property. Accommodations sold on an annual or a time-sharing basis or otherwise not available for general public use will not be counted toward the minimum requirements.
- e) Attraction. An attraction must fall under one of the categories listed below. An attraction, except as otherwise provided, must have adequate legal parking accommodations, provide public restrooms with sinks and running water (Commerce Park excluded), be open a minimum of 30 days per year, and have a minimum annual per capita usage pursuant to [Exhibit 2-23](#). If there is an admission charge, it must be readily visible to prospective visitors at the point of entry.
  - Amusement Park. A permanent area which is open to the general public for activities such as picnicking, hiking, swimming, boating, entertainment rides, etc.



- **Arena.** A stadium, sports complex, auditorium, civic or convention center or racetrack, which has a capacity of at least 5,000 as determined by the Pennsylvania Department of Labor and Industry.
- **Business District.** An area within a municipality which is officially designated and signed as a business district by the local officials of the municipality.
- **College or University.** An institution which is approved by a nationally recognized accreditation agency and which grants degrees.
- **Commerce Park.** A group of commercial manufacturing facilities recognized and signed as a commerce park by the local authorities. Any Commerce Park that has been granted Keystone Opportunity Zone status is exempt from the requirements for minimum acreage and number of required businesses in [Exhibit 2-23](#).
- **Cultural Center.** A facility for the performing arts, exhibits, or concerts.

**Exhibit 2-23 Eligible Attractions for Logos**

Type of Attraction	Specific Criteria	Urban Area	Rural Area
College or University	Enrollment (Full & Part Time)	2,500	1,200
Business District	Number of Businesses	75	50
	Municipal Population	15,000	10,000
State or National Park, Recreational Area, Forest, State Game Land, Cemetery	Certified Attendance Figures	20,000	20,000
Amusement Park, Arena, Cultural Center, Facility- Tour Location, Fairground, Golf Course, Historic Site/Area, Museum, Observatory, Ski Area, Unique Natural Area, Zoo/Botanical Park	Certified Attendance Figures	20,000	12,000
Type of Attraction	County Population	Acres	Businesses
Commerce Park	< 100,000	5	3
	≤ 500,000	10	5
	≤ 1,000,000	15	10
	> 1,000,000	25	15

- **Facility, Tour Location.** A business that conducts daily or weekly tours on a regularly scheduled basis. Eligible attractions may be on-site tours that operate year-round at

facilities such as plants, factories or institutions. Eligible attractions may also be off-site tour-providers services that operate tours daily or weekly at least six months per year for local attractions of historical, architectural, cultural or scientific interest to tourists, such as battlefields or historic districts. Tours of the off-site type are typically conducted by boat, carriage, motor coach, railway, etc. For tour-provider services, only the point of purchase for the service shall be signed.

- Fairground. A tract of land where fairs or exhibitions are held, and which has permanent buildings including, but not limited to livestock exhibition pens, exhibition halls, bandstands, etc.
- Gaming. A facility issued a Category 1, 2 or 3 slot machine license by the Pennsylvania Gaming Board under provisions of Act 71 of 2004.
- Golf Course. A facility open to the public and offering at least nine holes of play. Miniature golf courses, driving ranges, chip-and-putt courses, and indoor golf shall not be eligible.
- Historical Site or District. A structure or area recognized by the Pennsylvania Historical and Museum Commission as a historic attraction in the National Register, individual properties, or historic districts in Pennsylvania. Historic districts shall provide the public with a single, central location, such as a self-service kiosk or welcome center, where motorists can obtain information regarding the historic district.
- Museum. A facility, open to the public at least 100 days per year, in which works of artistic, historical, or scientific value are cared for and exhibited to the public.
- Observatory. A facility designed and equipped for making observations of astronomical, meteorological, or other natural phenomena.
- Recreational Area. Recreational attractions including, but not limited to, bicycling, boating, fishing, hiking, rafting, swimming, picnicking, snowmobiling, or cross country skiing.
- Shopping Center/Antique & Flea Market. A shopping center is a group of stores separated by floor to ceiling partitions, which has a minimum of 10 stores and a minimum of 400,000 square feet or has a minimum of 30 stores and a minimum of 100,000 square feet. An antique & flea market is a group of 75 or more vendors or having a total area of 30,000 square feet, that specializes in the sale of antique and/or flea market items; such applicants shall certify that they comply with Pennsylvania's sales tax laws and regulations.
- Ski Area. A downhill skiing area with equipment rentals, or a cross country ski area with equipment rentals and a minimum of 5 miles of marked and groomed trails.
- State and National Park, Forest or Cemetery, or State Game Land. An area designated by and under the jurisdiction of the National Park Service, the Veterans Administration, Pennsylvania Department of Conservation and Natural Resources, or Pennsylvania State Game Commission.
- Unique Natural Area. A naturally occurring area which is of outstanding interest to the general public, such as a waterfall or a cavern.
- Visitor Information Center. A visitors information center open at least 6 months each year, including 9 hours each day between Memorial Day and Labor Day, and 8 hours each day during the balance of the open season. The facility shall have an attendant on duty during the open hours, and provide free access to travel literature, rest rooms, and drinking water.

Centers other than those owned and operated by the Commonwealth of Pennsylvania must be administered by the appropriate local tourist promotion agency.

- Winery. A licensed site which produces a maximum of 200,000 gallons of wine per year. Sites shall maintain a minimum of 3,000 vines or 5 acres of vineyard in the Commonwealth; be open to the public for tours, tasting and sales a minimum of 1,500 hours per year and provide an educational format for informing visitors about wine and wine processing.
- Zoological/Botanical Park. A facility in which living animals or plants are kept and exhibited to the public.

**Distance to Services**

The normal maximum distance that services may be located from the end of the off-ramp to qualify for a logo is as follows:

<u>Service</u>	<u>Distance</u>
Gas	1.0 mile
Food	2.0 miles
Lodging	3.0 miles
Camping	5.0 miles
Attraction	- 5.0/15.0 miles*

\* 5.0 miles from an interchange identified by the Department's Urban Boundary Classification Maps, or 15.0 miles from a rural interchange

The measurement to each business shall be along both public and private roadways and driveways delineated by pavement markings, signs and other traffic control devices. The distance is measured by computing the travel length from the terminus of the exit ramp of the most convenient interchange, to the following location:

- Gas, food, lodging and camping. The termination point is the primary building entrance for the service.
- Attractions. The termination point is the primary building entrance for the service, except the termination point for attractions with satellite parking is the gate, ticket booth or other type of primary entrance to the parking area.
- Business district or historic site. The termination point is the District boundary.
- Commerce park, recreation area, shopping center, State and National Park, Forest or Cemetery, or State Game Lands. The termination point for measuring is the entrance to the primary parking area for the facility.

The maximum distances for gas, food and lodging may be increased an additional 1.0 mile if the average distance to the two adjacent interchanges is more than 5 miles, as indicated on the Department's Official Transportation Map.

**Unacceptable Locations for Logo Signs**

Logo signs shall not be authorized at the following locations or under the following circumstances:

- a) At interchanges with other freeways.
- b) At interchanges where space for only one sign installation exists except under the following conditions:
  - In urban areas, one logo sign shall be authorized, which shall be solely for the Attraction category
  - In rural areas, one logo sign shall be authorized, using the three service panel, comprised of two logos for each of three-service categories. At the initial installation, the Attraction service shall be given priority, and the two other services shall be determined in accordance with the Section [Space Allocation by Service Type](#) on page 2-87 . After the initial installation, any open service to be filled on the three-service panel shall be filled in accordance with the Section [Space Allocation by Service Type](#) on page 2-87 (and Attractions shall not be given specific priority, even if there were no Attractions signed after initial installation).
- c) In areas of high congestion, such as within a central business district or where long traffic delays frequently occur.
- d) When the number of turns required from the crossing route prior to the driveway of an establishment is greater than the following:
  - Gas – two turns.
  - Food – three turns.
  - Lodging – three turns, except four turns if the facility is within one mile of the exit ramp terminal.
- e) Where an illegal movement is required to access a business, or where it is not convenient to return to the original direction of travel.
- f) Where long sections of structure, retaining wall and/or installations of noise wall limit the ready placement of ground-mounted logo signing.
- g) At interchanges where it is necessary to direct motorists back in direction to service establishments located at a previous interchange.
- h) Where the Department determines that for safety, operational, or other explained reasons the installation of logo signs is not in the best interest of the traveling public.
- i) At any interchange approach other than that which most directly and conveniently accesses the service establishment.
- j) Where a maximum of four logo sign installations exist on any approach to an interchange.
- k) Where a trailblazer for a business would be required off the right-of-way of a State highway, unless the business obtains all required approvals and permits from the local officials for the trailblazer within 130 days from its application for logo signing.
- l) In no event shall a participant be signed at more than one interchange for each direction, for each service on a specified traffic route.

### Continuation of General Motorist Service Signs

General motorist service signs display symbols or words for services such as “GAS,” “FOOD,” “LODGING,” “CAMPING,” “VISITOR INFO,” “DIESEL,” “HOSPITAL,” and “STATE POLICE.”. Whenever possible, these general motorist service signs should be removed as soon as logo signing is installed at a particular location.

However, if only certain types of services at an interchange participate in the logo signing program (e.g., only gas and lodging), the remaining services (e.g., food and camping) can continue to be signed via a general motorist service sign provided sufficient spacing is available along the mainline to erect the signs. In no cases, other than mentioned above, should general motorist service signs duplicate logo signing for a particular service. General motorist service symbols may be attached to the supports of mainline logo signs in the absence of separate mainline general motorist service signs. When general motorist service directional signs are placed along ramps, if possible, the signs should not be placed together with logo ramp signs on the same post.

Businesses with billboards in violation of State or federal laws or regulations, will not be authorized to participate in the Logo Sign Program.

### Logo Requirements

- a) **Design.** Business logos may consist of a symbol, trademark, or a legend message identifying the name or abbreviation of the specific business. Attraction logos shall include a legend message identifying the name of the attraction. All logo designs shall be reviewed and approved in accordance with Department standards prior to fabrication. Logos which resemble any official traffic-control device or which are determined to be in poor taste by the Department will be prohibited.
  - **Size and Shape.** All logos shall be rectangular in shape and conform to the following sizes:
    - Mainline logos (logos directly along the Interstate highway or other freeway) shall be 60"x36" for gas services, food services, lodging services, camping services and attractions.
- b) All ramp and trailblazer logos shall be 30"x18", except where authorized otherwise by the Department.
- c) **Legends.** A legend which is not part of a regionally or nationally recognized trademark should be as large as possible, preferably with only one or two lines of messages. Only one registered trademark may be included on a logo panel. Any portion of the trademark that appears to be a supplemental message may be excluded. The maximum amount of legend shall be three lines, each having up to 12 characters (i.e., letters, numerals, or spaces). The minimum size legend shall be 8-inch for mainline logos and 4-inch for ramp and trailblazer logos.
- d) **Color.** Logos may use any contrasting combination of standard highway colors, i.e., white, yellow, red, blue, green, orange, brown and black. Transparent inks or electronic cuttable films may be used to correlate with standard trademarks providing the colors provide good

readability during both daylight and nighttime hours. Colors that are critical to nighttime readability shall be at least as reflective as the standard silk-screened blue color, as determined by Department instrument testing. Fluorescent colors are not permitted.

- e) **Supplemental Messages.** When used, the minimum legend height for supplemental messages shall be 6 inches on mainline logos and 3 inches on ramp and trailblazer logos except for the RV Access Symbol. Supplemental messages shall not extend beyond the edge of the logo and onto the sign panel. The following supplemental messages may be used as applicable on logos:
- “24-HR” on gas or food logos provided the facility satisfies all eligibility criteria for all 24-hour periods subject to those criteria.
  - “DIESEL” on gas logos.
  - “NO TRUCKS” on gas logos (if a station has no facilities or parking for trucks).
  - “EV Charging” on any logos if the establishment provides a minimum of one Level 3 (480-AC three-phase circuit) electric vehicle charging connector.
  - “SEASONAL” on attraction and camping logos for those facilities open less than 12 months a year.
  - “CLOSED \_\_\_ DAY” shall be used on food logos if a food establishment is only open 6 days a week.
  - “RV Access Symbol” as shown in [Exhibit 2-31](#) and placed in the lower right-hand corner of the logo panel. The supplemental message will only be shown on the mainline panel and used for participants that meet all of the following criteria:
    - i. Minimum 50-foot radii for entering, exiting and negotiating thru the property
    - ii. Minimum 14-foot clearance for all overhead obstructions
    - iii. Gas establishments must sell diesel and have pumps with non-commercial nozzles
    - iv. Food, attraction and lodging establishments must provide at least two parking spaces with minimum dimensions of 12 feet in width and 58 feet in length
    - v. Camping establishments must provide two or more sites with vehicle spaces a minimum of 18 feet wide and 45 feet long
    - vi. The participant requesting approval for use of the RV Access Symbol must provide written documentation signed by a Professional Engineer licensed in Pennsylvania that all of the criteria are met
- f) **Materials.** Logos shall be fabricated on an aluminum substrate with a minimum thickness of 0.080 inch. All colors in the logo shall be made from either Department approved Type III or IV retroreflective sheeting or transparent inks on Type III or IV white retroreflective sheeting.
- g) **Approvals.** All logo designs and supplemental messages, and any revisions thereto, shall be submitted to the Department (through the Logo Signing Trust) for review and approval. Submissions shall include sufficient layout information to determine compliance with size, shape, color, legend and material requirements. Letter sizes for all legend proposed as part of the logo design must be clearly marked. The Department may request a small retroreflective sign sample of any custom-mixed colors to determine nighttime reflectivity. No logos or supplemental messages shall be manufactured until approval is received.

---

## Sign Panels

### Location

- a) Separate Sign Panel. Except as provided later in this section, a separate sign panel shall be provided for each type of service for which logos are displayed. In the direction of traffic, the sequential order of sign panels shall be in the order of attraction, camping, lodging, food, and gas, except for existing installations that do not conform to this order, which installations will remain until new signing work requires relocation of such panels. Additionally, a new sign may be installed out of sequence if in the future it is installed in a combined service format, with the future additional service placed in the correct sequence. Signs shall be positioned to take advantage of natural terrain or guide rail, to have the least impact on the scenic environment and to avoid visual conflicts with other signs.
- b) Specific Service Signs. Specific service signs may be installed between the previous interchange and a point 800 feet in advance of the exit direction sign or "NEXT RIGHT" sign at the interchange from which the services are available. A minimum 800-foot spacing shall be provided between specific service signs, and between specific service signs and existing major guide signs. Excessive spacing should be avoided. Space which is closer to an exit should be fully used before specific service signs can be placed in advance of the first major guide sign.
- c) Ramp Signs. At single-exit interchanges where service facilities are not readily visible from the ramp, ramp signs (see [Exhibit 2-28](#) and [Exhibit 2-29](#)) shall be installed along the ramp or at the end of the ramp. Signs along the ramp should generally be installed on the right side of the ramp, but are permitted on the left side. A minimum 200-foot spacing shall be provided between all ramp signs, and between all ramp signs and other traffic signs on the same side of the ramp. Ramp signs are only authorized for businesses which are participating on the specific service signs.
- d) Trailblazers. Trailblazers may be installed for specific service sign participants when it is necessary to provide additional guidance to motorists after they exit from the ramp. All trailblazers shall be installed up to 300 feet before any required turn. Once the turn (or turns) is accomplished, no other confirmation trailblazers will be placed. Trailblazers for camping, lodging, food and gas are similar to ramp signs but do not include the generic type of service (see [Exhibit 2-28](#)). For attraction facilities, trailblazers will be the D7-4 TODS-type signs (see [Exhibit 2-30](#)). At double-exit interchanges, trailblazers may be installed along the crossroad near the end of the off-ramp for all services over 1 mile from the end of the ramp; distances and arrows shall be included.

Trailblazers will be grouped at the intersection by direction (straight, left and right) and stacked totem pole style beginning at the top with camping, then food, then lodging, and with gas on the bottom. Attraction trailblazers will be separate sign assemblies and shall not be mixed on the same sign assembly with trailblazers for camping, lodging, food or gas. Trailblazers for camping, lodging, food and gas are to be stacked a maximum of six signs in height on posts in accordance with Department criteria. Trailblazers for attractions are to be stacked a maximum of three signs in height on posts in accordance with Department criteria.

For attraction trailblazers a maximum total of six signs, three on each sign assembly, shall be installed at a given location. Attraction logo trailblazers will be on separate installations from Department TODS unless an agreement between the Trust and the Department provides otherwise. Existing Department TODS immediately become the responsibility of the Logo Signing Trust when functioning as attraction logo trailblazers, and will be subject to the annual fees discussed in the Section [Annual Fee and Additional Costs](#) on page [2-88](#).

- e) Local Signing Ordinances. Logo Signs are not advertising signs, but are guide signs designed to facilitate the safe flow of vehicular traffic by providing directions to essential highway motorist services and general attractions. § 2002(10) of the Administrative Code of 1929, 71 P.S. § 512(10), bestows on the Department “exclusive authority and jurisdiction over all State designated highways.” The Department is accordingly not subject to the mandates of local ordinances with regard to matters such as the type, size and location of signs within the right-of-way of a State highway. Nevertheless, the location of all signs will be established to avoid blocking motorists’ lines of sight when entering the highway from side roads and driveways.
- f) Outdoor Advertising Sign Structures. Because Logo Signs are for the purpose of facilitating the safe flow of vehicular traffic, installation is subject to this policy and referenced statutes, regulations, policies, and handbooks. Where, however, a Logo Sign may be properly sited at various points in a given area, the location of any legally existing Outdoor Advertising Sign Structure, as defined in 67 Pa. Code Chapter 445, relative to the Logo Sign may be considered prior to final location approval. The physical obstruction of visibility of an Outdoor Advertising Sign Structure on the same side of the traveled way and within 500 feet of the proposed location of the Logo Sign will be considered adequate justification for selecting an alternative location within the allowable range.

### Composition

- a) Single-Exit Interchanges. Specific service signs shall include the name of the type of service followed by the exit number displayed in one line above the logos. Specific service signs may have up to six “gas,” “food,” “lodging,” “camping,” or “attraction” logos. Half-size specific service signs (as illustrated in [Exhibit 2-24](#)) may be used if full-size specific service signs are not necessary. Four-panel size specific service signs should be used if a six-panel specific service sign is not necessary. A 5-year future time frame should be considered to determine the sign size. As noted earlier, a single sign may be installed for the Attraction category at urban exits and a single three-service panel sign may be installed at rural exits.
- b) Double-Exit Interchanges. At double-exit interchanges, such as a cloverleaf interchange, specific service signs shall generally consist of two sections, one for each exit. The top section should display the logos for the first exit and the lower section should display the logos for the second exit. The name of the type of service followed by the exit number should be displayed on a line above the logos in each section. The number of logos in each section shall generally be limited to three each for “gas,” “food,” “lodging,” “camping,” or “attraction.” When a type of motorist service is only at one exit, a full-size or half-size specific service sign may be used as discussed in the Section [Composition](#) (part b) on page [2-86](#). As noted in the Section [Unacceptable Locations for Logo Signs](#) (part b) on page [2-81](#), a single sign may be installed for the Attraction category at urban exits and a single three-service panel sign may be installed at rural exits.
- c) Remote Rural Interchanges. In areas where only one or two qualified facilities are available for each of two types of services, logos for a maximum of two types of services may be displayed on the same specific service sign. The name of each type of service shall be displayed above its respective logo(s) as indicated in the bottom drawing in [Exhibit 2-25](#). Logos should not be combined on a sign when it is anticipated that additional service facilities will become available during the next 5 years. When it becomes necessary to display a third logo for a type of service displayed in combination, the logos involved shall then be displayed in compliance with the Section [Composition](#) (part a and b) on page [2-86](#).
- d) Ramp Signs. Ramp signs shall conform to the general requirements of [Exhibit 2-28](#) and [Exhibit 2-29](#). A maximum of six logos for gas, food, lodging, camping service, and attractions shall be



displayed along the ramp. A maximum of three logos for each of two different types of services may be combined on the same sign panel. The name of each type of service shall be displayed above its logo(s). For services over 0.5 mile from the ramp terminal, ramp signs shall include the distance to the service (to the nearest whole mile) below the directional arrow.

- e) **Dual Signing.** It will not be permissible to insert wording for a convenience store or a mini-mart on a gasoline logo sign panel. Current policy does not permit such dual signing on either the small or large size gasoline logo sign panel. All gasoline logos will conform to the general requirements of [Exhibit 2-27](#). A similar dual combination of signing is not permitted for other services (i.e. attraction/food, lodging/gasoline, lodging/food, etc.). The combining of two or more logos for the same service type (i.e., food/food) on the same logo panel is also not permitted.

### Logo Position Orientation

Logo positions on panels are determined by nearness to interchange in accordance with the Section [Excess Number of Eligible Businesses](#) (part a and b) on page [2-89](#), beginning at the top left position on the panel and proceeding to the right, then left to right on the second and third rows, ending at the bottom right position. Existing logo orientations which are not oriented in this manner shall be permitted to remain so.

### Space Allocation by Service Type

Sign space is generally allocated according to demand on a first come, first serve basis. Where the number of service types with eligible businesses fills or exceeds the capacity of the available sign space, the following procedures shall apply. The intent of these procedures is to provide directional information for the greatest variety of motorist service types rather than limit such information to service types with the highest concentration of businesses to the exclusion of other service types.

- a) **New Exits in the Program.** First priority shall be given to provide sign space in each service type for which there are eligible applicants. Afterwards, sign space shall be allocated proportionately to the number of eligible applicants within each service type. Allowances shall be made for adjustments to this procedure necessitated by limitations imposed by sign design formats, geographical features in the field and sign sequence requirements.
- b) **Existing Exits in the Program.** Where an application from an eligible business would require that an existing sign of its same service type be expanded to accommodate the additional business, resulting in the exclusion of any other unsigned service type from the program due to a lack of remaining sign space, a re-inventory shall be made of the eligible businesses of the remaining unsigned service types. Any eligible businesses will be contacted and provided an opportunity to apply for signing. After the deadline for applications, the sign space shall be allocated with priority given to any unsigned service type in proportion to the number of eligible applicants in each of the unsigned service types. If no business in an unsigned service types responds to this application opportunity, an existing service sign may be expanded even if it would result in the future exclusion of an unsigned service type.
- c) **All Exits.** When applications from eligible businesses are received from more service types than can be accommodated, the closest eligible applicant to the approach, as determined in accordance with Section [Excess Number of Eligible Businesses](#) on page [2-89](#) shall be the determining factor for sign space allocation. However, a second sign panel of the same service type will be permitted to accommodate the excess businesses provided none of the provisions under the Section [Unacceptable Locations for Logo Signs](#) on page [2-81](#) are violated.

## Application and Agreements

### Application

- a) Initial Contacts. If an interchange is approved by the Department for logo signs, businesses in the vicinity of the interchange will be surveyed to determine eligibility. The program and the costs involved will be explained to the eligible businesses by the administering agency.
- b) Logo Agreement. An eligible business that wishes to participate in the program and which can be accommodated will be required to enter into a “Logo Agreement” with the administering agency and pay specified “up-front costs” which will be used to pay the business’ share of the total project costs (e.g., the costs of making, providing, and erecting the sign panels, attaching the logos and administering the program). The arrangement will further bind the business to pay an annual fee as discussed in the next section (**Annual Fee and Additional Costs**). Subject to policy limitations on bumping, the same participant-entity may enter into two or more separate logo agreements with the administering agency, requiring separate sign fees, in the same or different sign classification (i.e., Food, Gas, Lodging, Attraction), at the same exit, using separate and distinct trade names/logos. Further, participants may share qualifying requirements, such as rest rooms, seating, drinking water, availability, etc. on the same business site/tract of land wherever this can be reasonably accomplished.

### Annual Fee and Additional Costs

- a) Annual Fees and Compliance Forms. Participating businesses will be assessed an annual fee designed to cover preventative maintenance, the replacement of damaged sign panels, and the continuing administration of the program, and be required to return a completed compliance form satisfactory to the Administrator. The fee will be evaluated periodically by the administering agency to ensure an adequate fund for future projected expenses. Failure to pay the fee and/or return the compliance form within the specified time shall constitute breach of the Logo Agreement and will be cause for removal of the logos, and the assignment of liquidated damages incurred by the Trust because of the breach. At the time the annual fee is assessed, the businesses also shall be required to complete a business eligibility compliance form. Businesses participating in the attraction service category will not be assessed an annual fee for their trailblazer signs, but will be required to pay the full costs of repair and replacement of any attraction trailblazer as costs are incurred.
- b) Temporary Removal. If a business is closed for more than 2 weeks, its logos shall be removed, except for attraction and camping logos with the “SEASONAL” supplemental message. It will be the responsibility of the owner to notify the administering agency to remove the logos at the beginning of a closed period and to reinstall or uncover the logos upon reopening the business. A fee will be charged for temporary removal and installation.
- c) Logos. Businesses shall supply all new and replacement logos, and shall be responsible for the cost of installing replacement logos. All field work for new or replacement logos shall be performed by a Department pre-qualified contractor and authorized by the administering agency.
- d) Refurbishment. When the majority of logo sign panels need to be replaced (assumed to be every 10 to 15 years), additional fees may be assessed to cover the cost of replacing the signs or sign panels.

- e) Attraction Signs. A business that has an existing highway sign (e.g., a supplemental guide sign) may only qualify for a logo sign if they agree to fund all necessary construction costs associated with accommodating their sign.

#### Excess Number of Eligible Businesses

- a) General Rule. When all eligible businesses desiring logo signs cannot be accommodated, the order of opportunity to participate will be as follows:
- 1) With respect to food, gas, lodging, and camping logo signs, the closest establishments will be given the first opportunity to participate.
  - 2) With respect to attraction logo signs, those eligible businesses will be required to submit a traffic study prepared in accordance with guidelines established by the Institute of Transportation Engineers and certified by a professional engineer licensed to do business in Pennsylvania. The businesses with the greatest Annual Average Daily Traffic (AADT) volumes will be given the first opportunity to participate.
- b) Single-Exit Interchanges. When a surplus of eligible gas, food, lodging, camping, or attraction businesses exist at single-exit interchanges, businesses in those categories within 0.5 mile to the right or straight ahead of the exit ramp terminal will be given preference, followed by the businesses within 0.5 mile to the left. (This practice will help to share the available space on the two sides of the interchange and reduce the number of left-turn movements). After all participating businesses within 0.5 mile have been signed, the closest business to the ramp terminal in either direction will be signed.

#### Sale or Termination of Business

- a) Participants may not reassign a Logo Sign Agreement without the prior written consent of the Trust, which consent shall be the Trust's sole discretion. Participants agreements run with the tract of land for which the application was initially made and shall not be assigned to another tract of land, except if a Participant moves its location at the same logo-signed exit, and there is no change in business entity (i.e., no transfer of business ownership), the following shall apply:
- 1) If the business still qualified for signing under the Guidelines at its new location, it can remain in the Logo Program, under its existing Participant's Agreement, provided that the Participant executes an Addendum, modifying the location of the business and its signs, and pays the full cost of any removal of existing ramp or trailblazer signs, or the installation of any new ramp or trailblazer signs.
  - 2) If the Participant does not qualify for participation in the Logo Program at its new location, the Participant shall be removed from the logo program with no refunds, since the relocation was the result of action by the participant alone.
  - 3) If the business still qualifies under the Guidelines at its new location, it will still be subject to the bumping procedures as outlined in the Section [Removal of Logo Signs](#) on page 2-90.
- b) Businesses which withdraw from the logo program because of the sale or closing of their business, or for any other reason shall not receive any reimbursement.
- c) If a participating business is sold, and the new owner wants to continue in the logo program, the new owner shall proceed as follows:

- 1) If the business is sold for a different use or if the owner withdraws from the logo program, the privilege to participate in the logo program shall be offered to the next qualified business as discussed in the Section [Excess Number of Eligible Businesses](#) on page 2-89, which may or may not include the new owner, depending on the qualifications set forth. If the participating business is sold for a different use and the new owner wants to qualify for the logo program, then the new owner shall follow the qualification procedures for any new business participant and shall pay the same fees as any new participant in the logo program; or
- 2) If a participating business is being sold to a new owner for the same use, and the new owner wants to continue participation in the logo signing program at the same location, the existing participant and the new owner shall apply jointly for Assignment of the existing Logo Sign Agreement, verifying that the business will continue in the same classification (i.e., gas, food, lodging, campground, or attraction), at the same location; then in such event, the existing Agreement may be assigned for the remainder of the term of such existing Logo Sign Agreement. Such Assignment shall be in a form determined by the administering agency, and subject to the payment of a fee for Assignment as determined from time to time by the administering agency. The application for Assignment by the existing participant and the new owner shall be made not later than the date of closing on the transfer of the participating business or the effective date of transfer of ownership of the participating business, whichever shall first occur, and such request for assignment shall include a verification by the participating business and the new owner of said closing date and such date of transfer of ownership.

### New Businesses

If a new business is established or if a non-participating business is interested in participating in the logo program, the business may request to participate in the program subject to the following:

- a) All new businesses will be required to pay the same costs as outlined in the Sections [Application](#) on page and [Annual Fee and Additional Costs](#) on page 2-88.
- b) If the maximum number of logos is in place, applications will be considered in accordance with the priorities established in the Section [Excess Number of Eligible Businesses](#) on page 2-89 and the removal provisions of in the Section [Removal of Logo Signs](#) on page 2-90. Businesses will not, however, be forced to vacate a sign due to another business during their first 5 years in the logo program. If a participating business is forced to vacate a sign panel due to another business, the business will be reimbursed for a depreciated portion of the up-front cost, based on a 10-year straight-line depreciation schedule.
- c) Businesses under construction, or closed businesses planning to reopen under new management, may submit applications for logo signs up to 3 months in advance of the scheduled date of the business opening.

### Removal of Logo Signs

- a) Removal Necessitated by Department Action. Since the amount of available signing space at interchange areas is limited, the Department reserves the right to remove logo signs and to provide an initial cost reimbursement to participating businesses under certain circumstances. Logo sign removal may prove to be necessary under any of the following circumstances: (1) if the space is needed for necessary traffic control signs; (2) if the access control features of either the mainline or

the crossing routes are changed; or (3) for other safety or operational reasons based on an engineering study.

If logo signs are to be removed for any of these reasons, the businesses will be reimbursed by the Logo Signing Trust for a portion of the up-front costs over the first 10 years. Reimbursement will be computed based on straight-line depreciation. The costs of sign removal and sign disposal will be borne by the Department.

- b) **Renovations.** A business will be given 6 months from the date of closing to complete renovations and reopen for business, provided that the participant maintains its logo sign contract in an active status by paying the annual fees in a timely fashion. The temporary removal provisions of the Section **Annual Fee and Additional Costs** (part b) on page **2-88** shall apply during the closed period. If renovations are not completed within 6 months, then the logo is to be removed permanently and the contract voided. If a business is closed for any purpose other than renovations, and no assignment agreement is presented for approval at the time that the business is closed pursuant to guidelines procedures, the contract immediately becomes void, and the logo sign is to be removed.
- c) **Removal Caused by an Excess of Eligible Businesses.** If the maximum number of logos is in place on a sign panel, new applications by other businesses for inclusion on an existing logo sign will be considered in accordance with the priorities established in the Section **Excess Number of Eligible Businesses** on page **2-89**. These priorities are consistent with standard logo signing practice, and they reflect the concept of providing maximum service to the motorist. An excessive number of eligible businesses present at a signed interchange may necessitate the removal of one or more existing participants. This removal will be accomplished according to the following:
  - 1) **Closer Business Bumping Criteria (Gas, Food, Lodging and Camping).**
    - A. Implementation of "Closer Business Bumping" will be applied in sequential order by type of service beginning with the farthest participating business and proceeding inward toward the closest participating business. At single-exit interchanges, the ranking will be in accordance with the Section **Excess Number of Eligible Businesses** (part b) on page **2-89** when all businesses of a type are within 0.5 mile of the ramp terminals.
    - B. No replacement of a business (bumping) will take place at any interchange for any reason until the furthestmost located business on any filled (and already expanded) three-or-six-panel logo sign has been participating in the logo program for a minimum of 5 years. Applications and bumping requests will not be accepted more than 60 days prior to the 5-year anniversary date, and a physical re-inventory will not commence until on or after the 5-year anniversary date.
    - C. Participating businesses will be entitled to receive a full 5-year duration of sign use. In no case will a participating business be forced to vacate a logo sign for another business during the first 5 years after installation of their logo.
    - D. Bumping will not be authorized where the business wishing to replace another business is already signed for another type of service at the same interchange with the same logo or essentially the same logo.
    - E. Specific interchange locations and specific logo signs subject to bumping procedures (i.e., those signs deemed to be already filled to capacity with existing,

participating businesses) will be determined by the Logo Signing Trust in coordination with the Department.

- F. No new “bumping” procedures shall be initiated at a specific ramp location until at least 1 year has transpired since the date of administering agency action on the last “bumping” request for the same service at the same ramp location. A “bumping” procedure will be initiated at an exit ramp location only upon written request of an eligible business operating at that exit ramp location, within the mileage distance specified by the Guidelines. Provided, however, one exception will be allowed to this 1-year policy; specifically, a brand-new business (which is located at an exit ramp qualified for the program and which business is opening for business for the first time or was constructed within such 1-year period) may initiate a “bumping” procedure before the 1-year period has transpired.

2) Greatest AADT Volume Bumping Criteria (Attractions).

- A. Implementation of “Greatest AADT Volume Bumping” will be applied in sequential order beginning with the participating business with the lowest AADT volume and proceeding upward toward the participating business with the largest AADT volume. At single-exit interchanges, the above criteria shall also be applicable.
- B. No replacement of a business (bumping) will take place at any interchange for any reason until the business with the lowest volumes on any filled (and already expanded) three- or-six-panel logo sign has been participating in the logo program for a minimum of 5 years.
- C. Participating businesses will be entitled to receive a full 5-year duration of sign use. In no case will a participating business be forced to vacate a logo sign for another business during the first 5 years after installation of their logo.
- D. Bumping will not be authorized where the business wishing to replace another business is already signed for another type of service at the same interchange with the same logo or essentially the same logo.
- E. Specific interchange locations and specific logo signs subject to bumping procedures (i.e., those signs deemed to be already filled to capacity with existing, participating businesses) will be determined by the Logo Signing Trust in coordination with the Department.
- F. No new “bumping” procedures shall be initiated at a specific ramp location until at least 1 year has transpired since the date of administering agency action on the last “bumping” request for the same ramp location. A “bumping” procedure will be initiated at an exit ramp location only upon written request of a business operating at that exit ramp location, within the mileage distance specified by the Guidelines. Provided, however, one exception will be allowed to this 1-year policy; specifically, a brand-new business (which is located at an exit ramp qualified for the program and which business is opening for business for the first time or was constructed within such 1-year period) may initiate a “bumping” procedure before the 1-year period has transpired.

3) Implementation Procedure. The following steps will be used when carrying out all Bumping Criteria.

- A. Whenever a business becomes aware, or is otherwise officially notified, that a specific logo sign for food, lodging, gas, camping, or attraction is filled to capacity, the business wishing to apply to replace another participant will contact the Logo Signing Trust and request information pertaining to replacement options and bumping.
- B. The first step to effect possible replacement of an existing business logo by another business will be the submission of a completed application.
- C. The Logo Signing Trust, in cooperation with the Department, will verify all qualifying data on the application and will conduct a complete resurvey of the interchange. All businesses eligible to “bump” will in turn be required to enter into a “Logo Agreement” and pay a specified fee by a specific date.
- D. A determination will be made as to what business must vacate the sign. Schedules will be established to effect as timely a removal and replacement of logo panels as possible.
- E. The business being replaced will be paid a prorated portion of the original cost by the Logo Signing Trust together with a prorated amount of their annual fee if paid. The reimbursement for the “up-front costs” will be the original cost to the business less 10 percent of that cost for each year the business logo sign being replaced has been on the panel. After 10 years, no reimbursement will be made as the life of the sign is considered to have been fully used.
- F. The effective date of logo removal and replacement under the above procedures will be the date resolved by the Trustees. This date will serve as the end of the billing period for establishing annual fee reimbursements.

### Relocation of Logo Signs, New (Added) Signs

If Department projects or operations involving maintenance, design, utilities, traffic control, drainage or construction necessitate the temporary or permanent relocation of logo signs, the Department will make every effort to relocate the logo signs to an agreed upon location at Department expense. In general, the Department will first determine: (1) if the services still meet applicable guidelines for signing; (2) if the relocation of existing logo signs is possible; and (3) whether new (added) signs or changed signs are needed as a result of changes in routing. Access control, travel distance, existing signing and the route of return to the freeway will be factors in such a determination. The cost of relocating or changing existing logo signs due to Department initiated actions will be paid for entirely by the Department. The cost of installing new (added) logo signs and/or new (added) trailblazers, if determined necessary as per Department signing policy, will continue to be the responsibility of the logo applicant. Agreements and cost arrangements for new (added) signs as per the Sections [Application](#) on page 2-88 and [Annual Fee and Additional Costs](#) on page 2-88 will apply.

### Construction of New Interchange or Reconstruction of Existing Interchange

When Department construction occurs which results in an exit that is deemed more operationally efficient than the exit at which a participant is currently participating and located, then the participant shall be required to transfer the location of its logo sign to the more operationally efficient interchange and be given two options: (1) the participant’s logo sign will be moved to the more operationally efficient interchange, and the participant’s logo signing agreement will be amended to change the description of its location; all other terms and conditions of the agreement would remain the same including the initial date of the

agreement (for program longevity purposes); the participant would not be charged for moving their logo sign to the new exit; or (2) the participant could apply as a new applicant/participant at the more operationally efficient interchange under the guidelines; in such an event, the participant agreement would reflect the current date which begins a new 10-year period for amortization purposes; the participant would pay full, current “up-front costs” as defined under [Application](#) on page 2-88; they would have their 10-year “up-front costs” rebated as defined under [Removal of Logo Signs](#) on page 2-90. Under both alternatives, the participant’s current logo sign will be removed.

### **Expansion of Existing Four-Logo Sign Panels to Accommodate Six-Logo Panels**

Prior to January 1990, a maximum of four lodging, food, or camping logos were permitted on a single sign installation. The current Department policy now permits a maximum of six lodging, food, camping, or attraction logos for these services (see [Exhibit 2-24](#)).

In those locations where four participating businesses have filled a four-panel logo sign, and when additional qualifying businesses wish to join the logo program, a site review will be conducted to determine if it is feasible to expand the sign or to relocate it to a position where an expanded six-panel logo sign can be installed.

If there is a demonstrated need and if sign expansion is feasible, the administering agency upon approval will systematically replace four-panel logo sign with six-panel signs as part of future construction projects incorporating at least eight interchanges. The two extra logo spaces on the larger signs will be made available to qualifying businesses as per established guidelines and fees. No separate costs for design or construction of the expansion will be assessed when the work is performed as part of a construction project involving eight interchanges or more.

If a four-panel logo sign is filled and if a single new business wishes to participate in the logo program immediately, the option available is that the business pay the normal program fees or bear the full design and construction costs of the expansion to six panels, whichever is greater. The above option would also apply if two new businesses wish to participate in the program immediately. In such case, normal program fees will be paid by each or the full cost of the expansion will be shared by the two new businesses, whichever is greater.

The expansion of mainline logo signs may be accomplished by expanding the sign back panel either horizontally or vertically, and by relocating or extending the posts. The decision as to how best to add sign area should be made after a thorough review of site conditions and in consideration of existing logo installations, the type, number and spacing of posts, aesthetics, and structural design requirements. Design proposals for logo sign expansion shall be reviewed and approved by the Department before sign design is finalized and before any construction work takes place. Proper mounting height and required breakaway characteristics for logo signs should be followed when mainline logo signs are expanded.

The Department or the Logo Signing Trust will not at their expense reconstruct a six-panel sign to reallocate unused space for the benefit of new business applicants. The determination that a sign is filled to capacity will be made by the Department. Any reallocation of space on an existing logo sign which involves deleting services, separating exits, or moving logos from top to bottom (or vice versa) will be made by the Department. In general, split service signs (those with two types of services displayed) will be considered filled whenever each specific service panel is filled. Reallocation of space on a sign from one service to another will not be allowed unless space is available along the mainline to properly accommodate one or more new signs. All changes to logo signs will be made consistent with applicable state and national standards and will require concurrence from the Federal Highway Administration.



## Funding and Responsibilities

### General

All costs associated with the design, erection, maintenance and administration of logo signs will be assessed of all participating businesses. The program will be administered on a non-profit basis by a trust. All signs will become Department property after erection.

The program is currently administered by the PA Tourism Signing Trust, and information is available at [www.palogo.org](http://www.palogo.org).

### Duties of a Logo Signing Trust

If the logo program is administered by a logo signing trust, the trust will be responsible to:

- a) Select an engineering firm to inventory eligible exits to identify potential businesses.
- b) Contact the businesses for promotional purposes.
- c) Establish the fee schedule and enter into an agreement with the businesses on a contractual basis.
- d) Collect fees from the businesses.
- e) Obtain signed compliance forms from applicants to verify business eligibility.
- f) Authorize an engineering firm to develop construction plans for Department and Federal Highway Administration approval.
- g) Coordinate with the Department relative to sign placement and obtain concurrence from Department District Offices upon completion of a construction contract.
- h) Bid and award the construction project.
- i) Inspect and maintain the sign panels.
- j) Report to the Department inquiries and/or complaints which may be received relative to existing logo signing.
- k) Prepare an annual report and submit it to the Department.
- l) Administer the program on a day-to-day basis.

### Audit

The logo program is administered by a Trust, and a financial audit shall be performed on at least a biennial basis.

### Annual Report

The Department, in conjunction with the Trust, will prepare an annual report for submission to the House and Senate Transportation Committees within approximately 120 days after each fiscal year, i.e., the 12-month fiscal period used by the program Administrator. The report shall summarize the number of businesses participating in the program, the fees charged for such participation, the methodology used to determine these fee amounts and the program's annual financial statements.

## Department Action

### Department Responsibility

Although the Logo Signing Trust administers the Logo Program, the Department will cooperate with, share file information, and provide expertise to the Trust and to engineering consultants who represent the Trust. The Department, through the Engineering District Offices, will assist the Trust and its design consultants in determining suitable locations for logo signing. The Department will field review logo signing and will accept in writing the completed logo signs at the conclusion of construction. The Department will maintain file copies of plans prepared by the Trust that show the logo sign locations. The Department will be responsible for logo program guidelines and regulations. The Department will conduct Quality Assurance field reviews to inspect logo sign installations.

Due to construction and other activities, the Department may occasionally undertake the resetting of existing logo signs. Logo signs are Department property and the Logo Signing Trust merely administers the program on our behalf to include installation and maintenance. Logo signs are to be accommodated during construction projects similar to accommodations for other guide signs. Note that the design criteria used for sizing the foundations for the breakaway systems and steel posts for existing logo sign panels is often significantly different than that used for a guide sign. Logo signs are designed for future expansion while using the same support foundation design, thus, the design criteria must take future expansion into consideration. The Department should contact the Trust before undertaking design work for resetting logo signs.

### Applicant Appeals

A business may appeal a denial for logo signing or bumping actions under Title 2, Pa. C.S., Sections 501-508 (relating to the Administrative Agency Law), by submitting a written request for a hearing within 30 days of the date of the denial notification. Businesses should submit appeals to:

Administrative Docket Clerk  
Pennsylvania Department of Transportation  
400 North Street-9th Floor  
Harrisburg, PA 17120-0096

The written request shall include a filing fee made payable to the "Commonwealth of Pennsylvania" and a copy of the denial notification.

At the time of publication, filing fees are listed at 34 Pa.B. 4081 (see <http://www.pabulletin.com/secure/data/vol34/34-31/1410.html>). Filing fees for appealing a logo decision is a Level II fee, and comes under the category of "motorist information sign matters." Businesses may verify the current fee by contacting the Administrative Docket Clerk at 717-772-2741.

### Changes in Program Administration

If for any reason the services of the non-profit Trust are terminated, all financial resources and records will become the Department's property for use as an on-going program.

Exhibit 2-24 Typical Signing for Single-Exit Interchanges

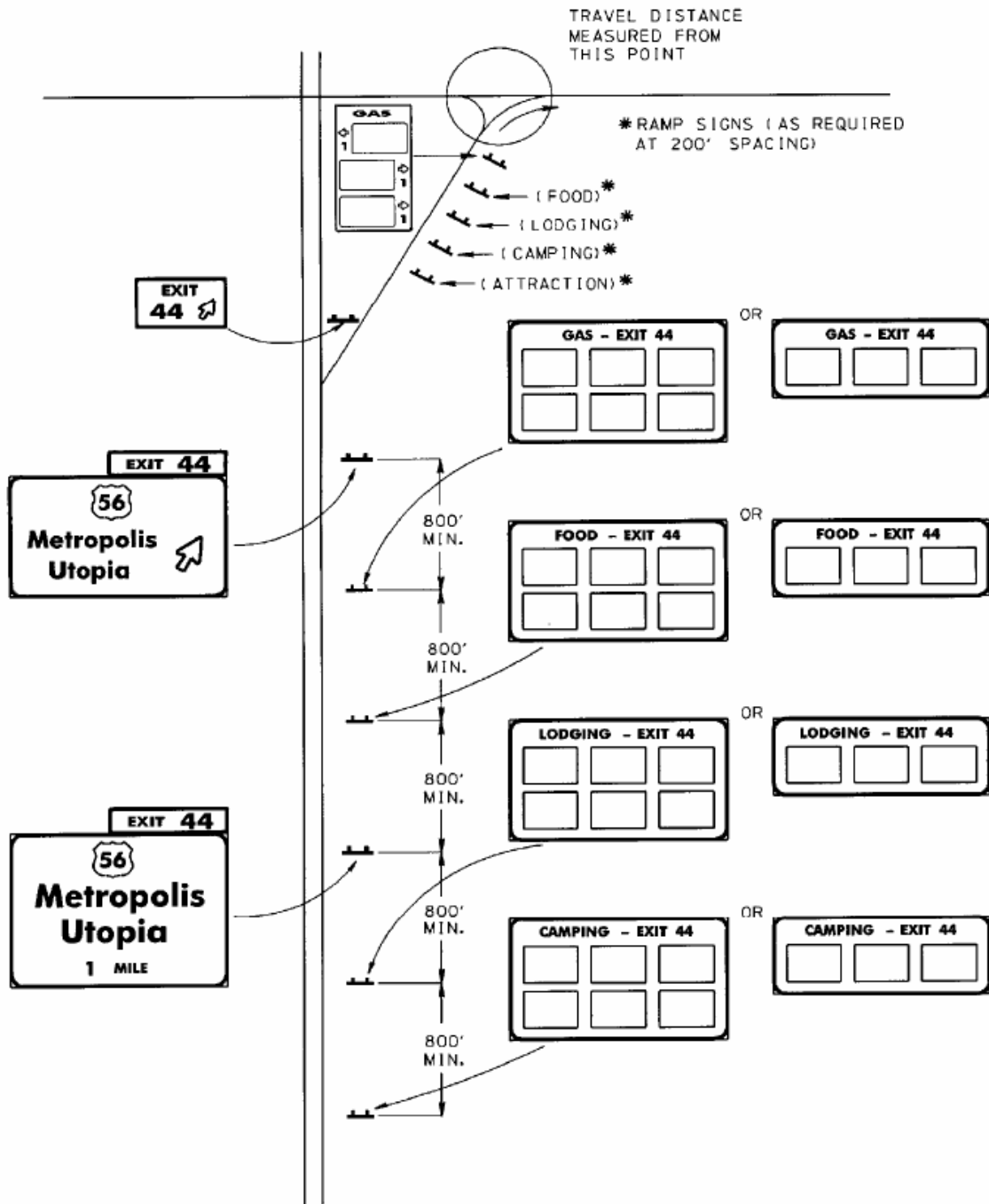

Note: A maximum of four logo sign installations (with a maximum of five specific service types) are permitted at a given interchange approach. In the above figure, an attraction logo may be substituted for any of the other services, provided the appropriate sequencing of signs is maintained. Each panel may be designed to accommodate two, three, four or six logos.

Exhibit 2-25 Typical Specific Service Signs

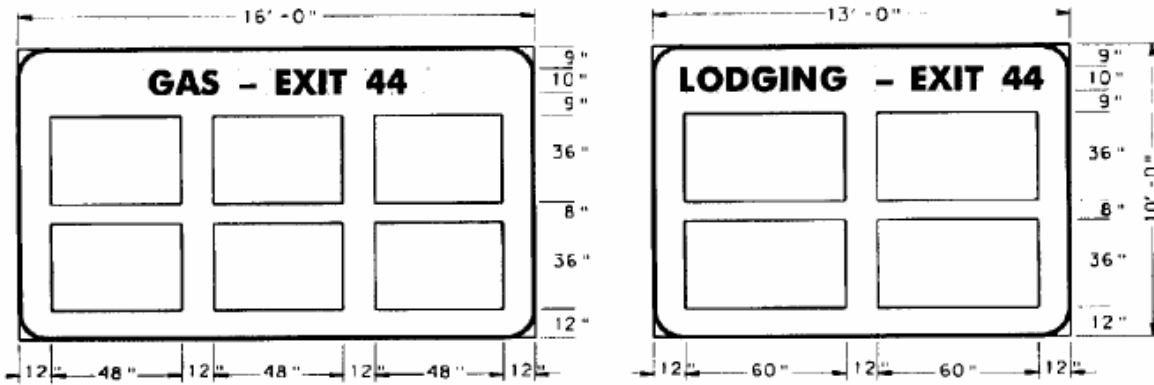

SINGLE-EXIT INTERCHANGE

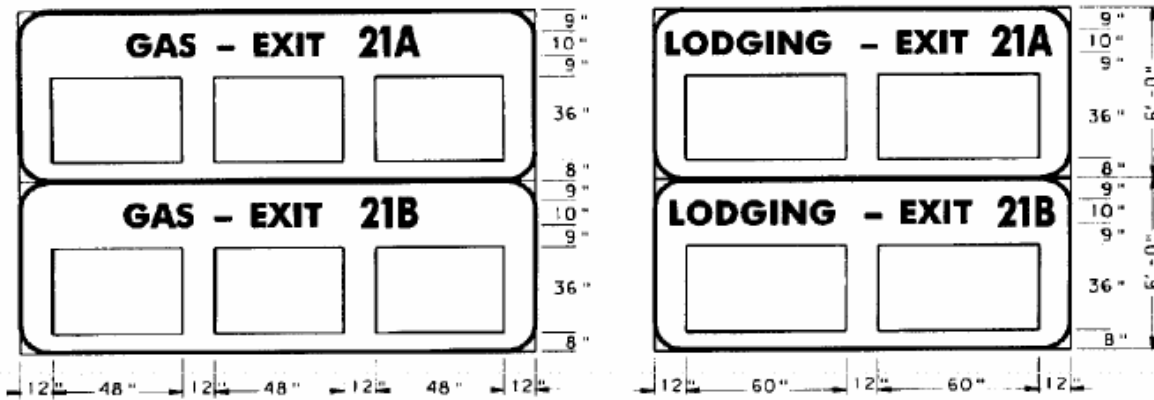

DOUBLE-EXIT INTERCHANGE

NOTES:

1. ALL LEGENDS TO BE SERIES D.
2. AT DOUBLE-EXIT INTERCHANGES, THE EXIT NUMBER AND THE LETTER AFTER THE EXIT NUMBER SHALL BE 13.3" HIGH.
3. 6 PANEL FOOD, LODGING, CAMPING AND ATTRACTION LOGO WILL HAVE SIMILAR DIMENSIONS TO 6 PANEL GAS LOGO SHOWN ABOVE, EXCEPT THAT LOGO PANELS WILL BE 60 INCHES WIDE.

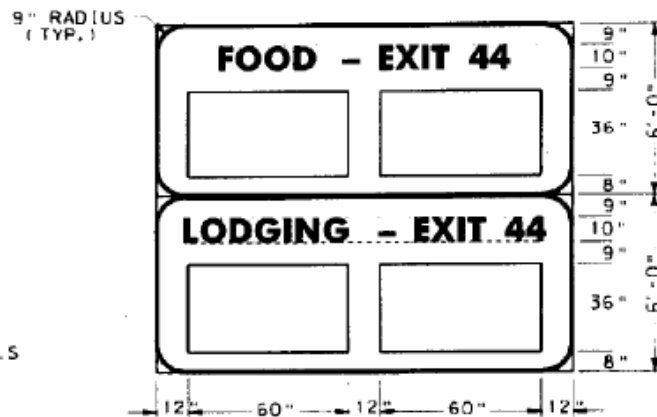

REMOTE RURAL INTERCHANGE

Exhibit 2-26 Typical Three-Service Sign

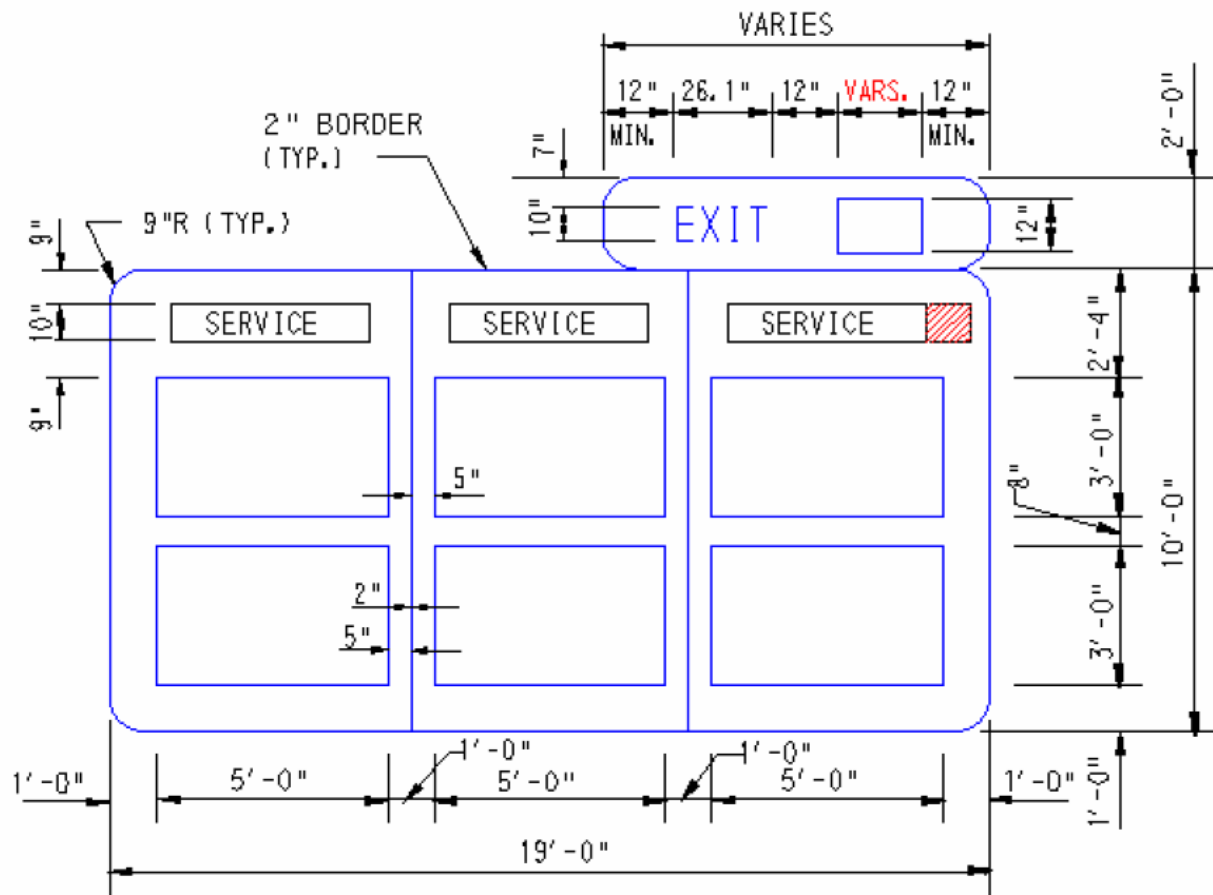
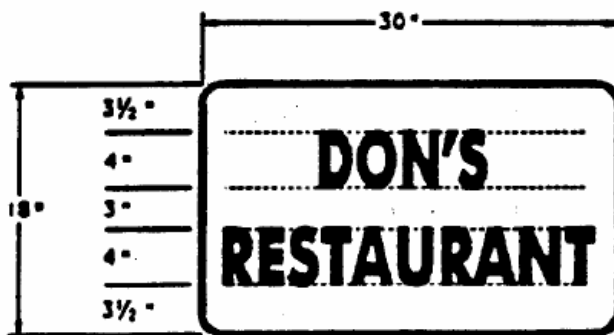
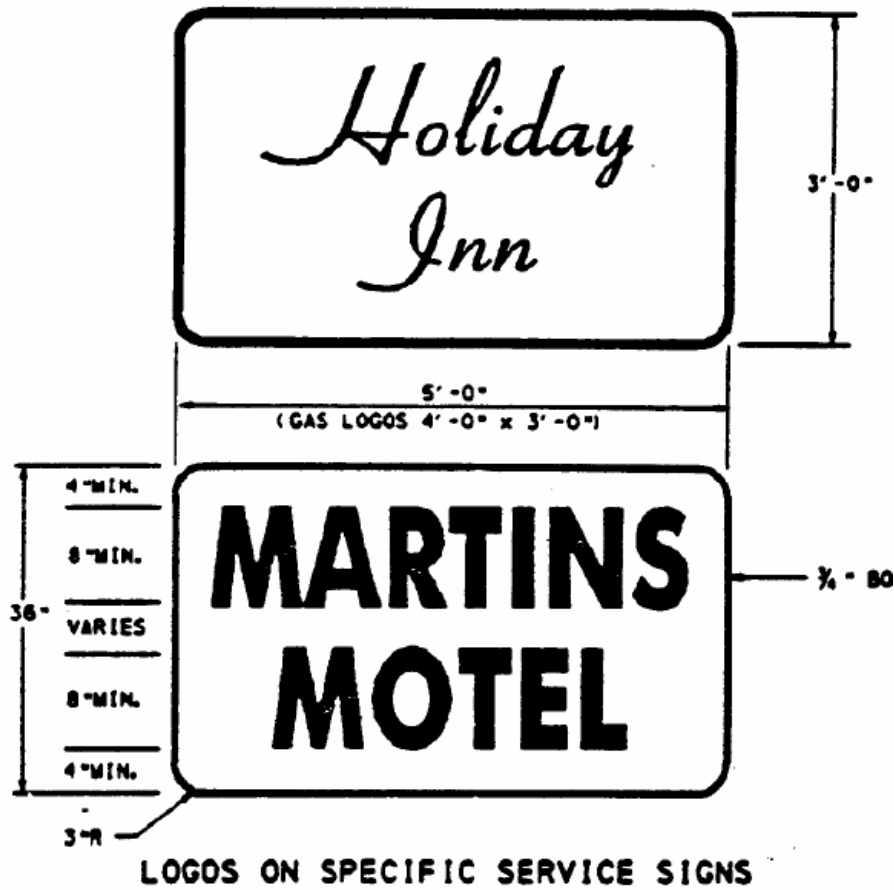
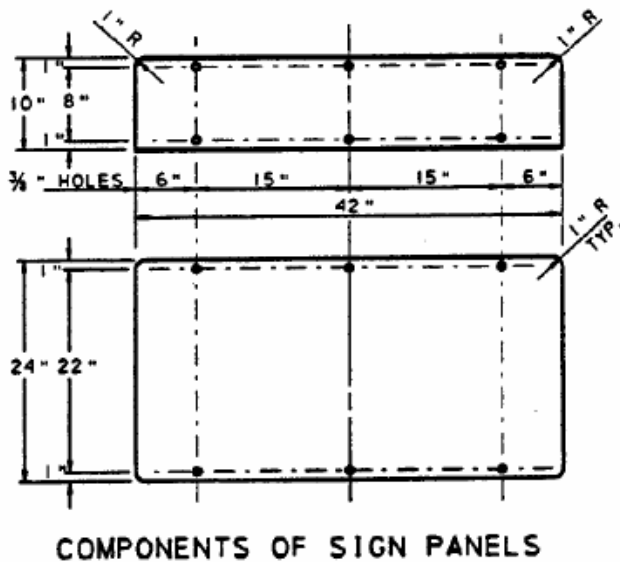
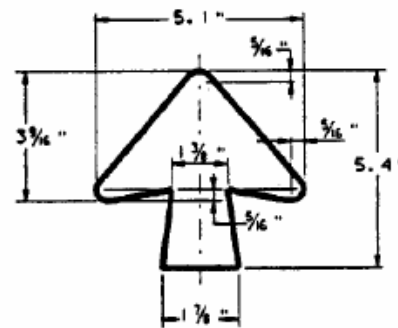
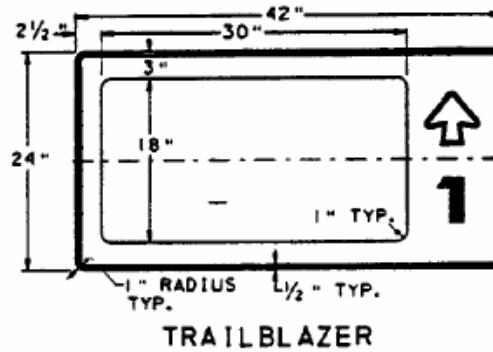
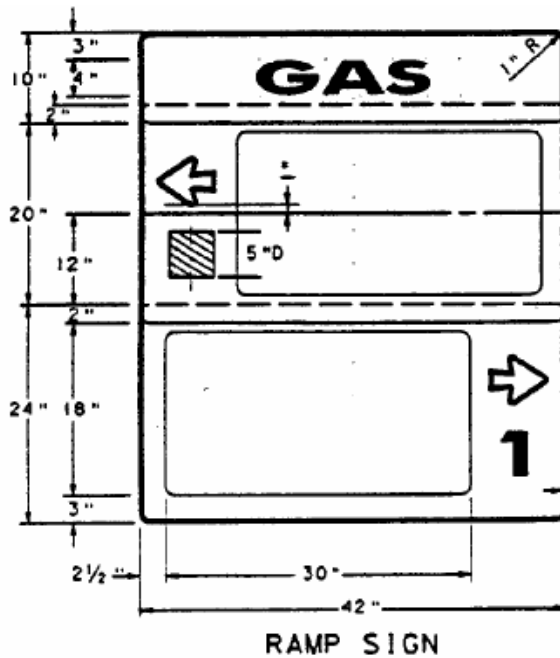

Exhibit 2-27 Typical Logos



LOGOS ON RAMP SIGNS AND TRAILBLAZERS

Exhibit 2-28 Ramp Signs and Trailblazers



**NOTES:**

1. THE TYPE OF SERVICE SHALL ALWAYS BE INCLUDED ON RAMP SIGNS, BUT NOT ON TRAILBLAZERS.
2. LOGOS WITH DESTINATIONS TO THE LEFT SHOULD BE ABOVE THOSE WITH DESTINATIONS TO THE RIGHT, AND CLOSER SERVICES IN EITHER DIRECTION SHOULD BE ABOVE THE MORE DISTANT SERVICES IN THE SAME DIRECTION.
3. SIGN PANEL COMPONENTS SHALL HAVE A MINIMUM THICKNESS OF 0.100 INCH.
4. RAMP SIGNS SHALL BE MOUNTED ON THE RIGHT SIDE OF RAMP. MOUNTINGS ON LEFT SIDE OF RAMPS SHOULD ONLY OCCUR WHEN EXTENUATING CIRCUMSTANCES PRECLUDE RIGHT SIDE INSTALLATIONS.

Exhibit 2-29 Ramp Sign Installation (4- and 6-Panel Logos)

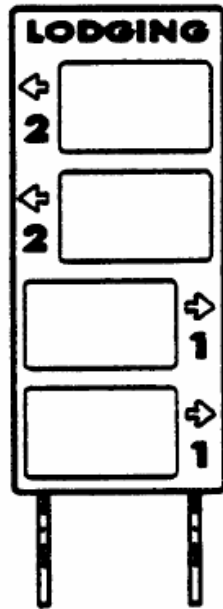

OR

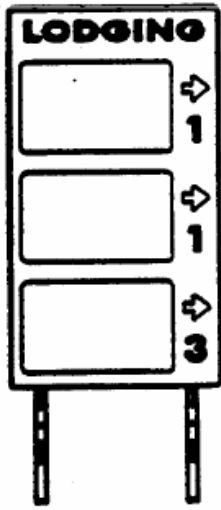
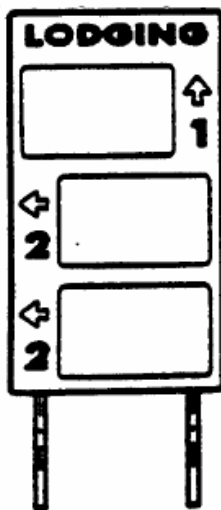
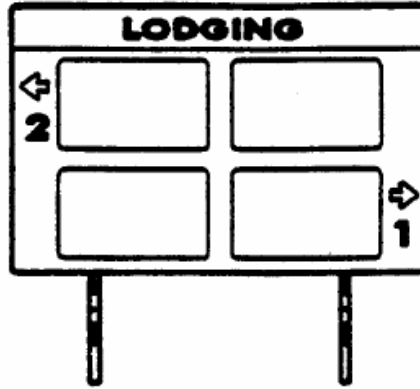

OR

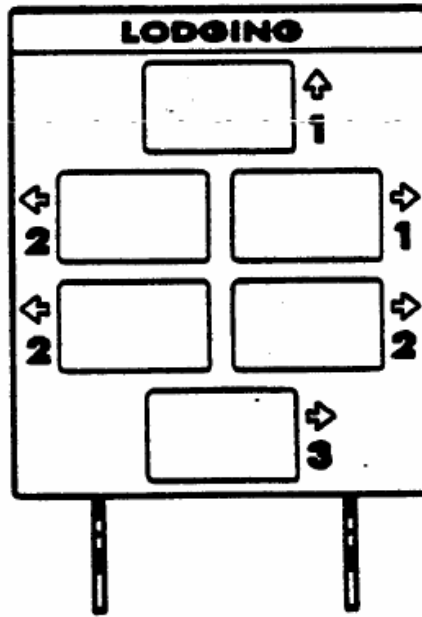
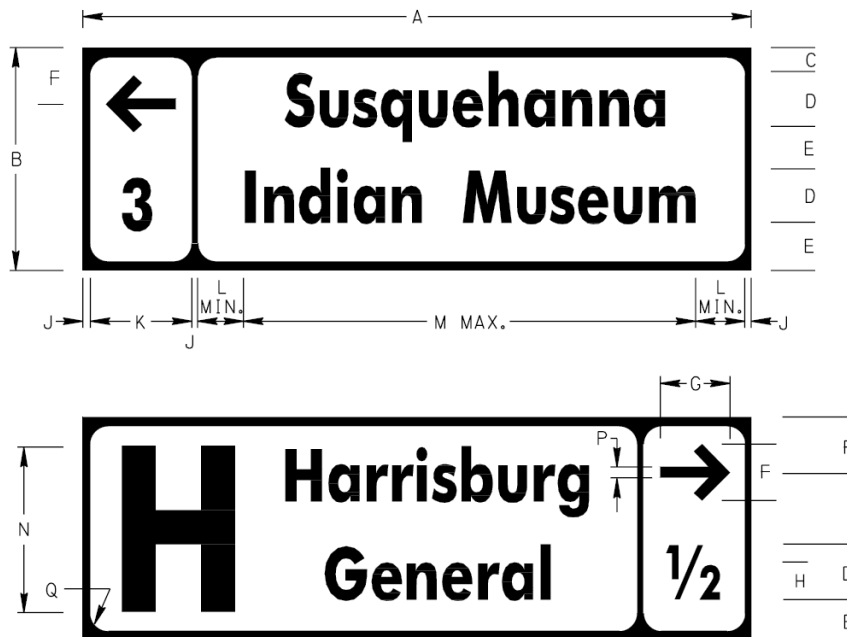



**Exhibit 2-30 Attraction Trailblazer**

(a) Justification. The Attraction Sign (D7-4) may be used on conventional highways to direct motorists to large tourist attractions in accordance with the Department's Attraction Signing Guidelines. One or two lines of legend may be used to identify the name or abbreviation of the attraction.

(b) Design. A rectangular directional box should generally be located on the left side of the sign for attractions that are straight ahead or to the left, or on the right side of the sign for attractions to the right. The box should generally include a directional arrow and a distance of 1/4, 1/2, 3/4 or the nearest whole mile, but the box may be eliminated if it is more appropriate to use directional information such as "DRIVEWAY ON LEFT", "LEFT 1000 FEET", etc., on the second line of legend. All legend should be "Clearview 1W, 2W or 3W" font, of the highest series possible. If necessary, the legend may be further condensed up to 35 percent. A generic symbol for hospital, campground or airport may be used in advance of the legend message.



DIMENSIONS - mm (IN)													
SIGN SIZE A x B	C	D	E	F	G	H	J	K	L	M	N	P	Q
1200 x 400 (48" x 16")	50 (2)	100 (4)	75 (3)	100 (4)	125 (5)	65 (2.6)	15 (0.6)	185 (7.4)	50 (2)	870 (34.8)	275 (11)	20 (0.8)	25 (1)
1800 x 600 (72" x 24")	90 (3.6)	150 (6)	105 (4.2)	165 (6.6)	188 (7.5)	100 (4)	20 (0.8)	280 (11.2)	75 (3)	1310 (52.4)	400 (16)	30 (1.2)	45 (1.8)

COLOR:

LEGEND AND BORDER:  
WHITE (REFLECTORIZED)

BACKGROUND:  
BLUE (REFLECTORIZED)

APPROVED FOR THE SECRETARY OF TRANSPORTATION

By : Alan C. Rowe Date : 01-03-06  
Chief, Traffic Engineering and Operations Division  
Bureau of Highway Safety and Traffic Engineering

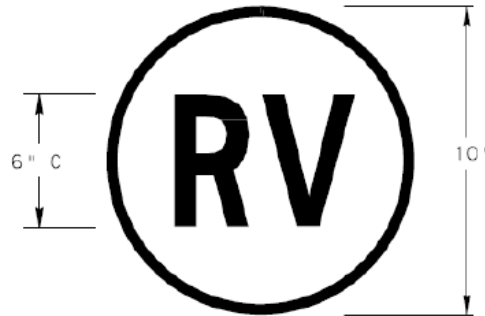
**Exhibit 2-31 RV Access Symbol**RV ACCESS SYMBOL

Yellow background  
Black text & Border – ½"

## 2.15 Congestion Management Signs

### General

Our highways are becoming more crowded every year and the traditional morning and afternoon “peak hours” in some metropolitan areas have expanded to encompass several hours.

Because of the congestion, highway improvements are necessary to eliminate the bottlenecks. However, since it is not physically possible to build our way out of congestion, traffic restrictions are frequently necessary to enhance highway operations.

This section identifies some techniques to help manage congestion. It is anticipated that the use of these signs and other similar types of signs will become more common in the future.

### Park and Ride Signing

One of the major purposes of congestion management signing is to move people and goods, rather than just moving vehicles. Therefore, an important congestion management objective is to increase the number of occupants per vehicle. The following types of signs encourage carpools and vanpools, and are especially valuable in the fringe metropolitan areas:

- Park and Ride Sign (D4-2)
- Car Pool Information Sign (D12-2)

### High Occupancy Vehicle Signs

High Occupancy Vehicle (HOV) lanes are sometimes established to give preferential treatment to high occupancy vehicles. These lanes are typically operated as inbound traffic lanes to metropolitan areas in the morning hours and as outbound traffic lanes during the afternoon hours. In addition to the following signs,

blank-out or variable message signs, moveable gates and channelizing devices are normally required in order to provide a safe operating system:

- Restricted Lane Ahead Sign (R3-10)
- Preferential Lane Sign (R3-11)
- Buses and Carpools Only Sign (R3-11-1)
- Carpool (\_\_\_\_) or More Occupants Sign (R3-11-2)
- Restricted Lane Ends Sign (R3-12)
- Restricted Lane Ahead Sign (R3-13)
- Preferential Lane Sign (R3-14)
- Restricted Lane Ends Sign (R3-15)

**Lane Restriction Signs**

In order to enhance the capacity of a highway, the following signs may prove useful:

- Trucks Use Right Lane Sign (R4-5)
- Truck Lane (\_\_\_\_) Feet Sign (R4-6)
- Left Lane No Buses Sign (R4-11)
- Left Lane No Trucks Sign (R4-11-1)
- No Trucks Buses Trailers in Left Lane Sign (R4-11-2)

**Ramp Metering Signs**

Ramp metering signals are in operation on some freeway ramps in the Philadelphia area and at a limited number of locations in other major metropolitan areas. The signing associated with ramp metering is determined on a case-by-case basis.

**2.16 Incident Management Signs**

**General**

Incidents are random events that reduce roadway capacity. A breakdown of 58,284 incidents recorded by Engineering District 6-0’s Service Patrol from July 18, 2000 through June 26, 2007 is as follows:

<u>Incidents</u>	<u>Percent</u>
Disabled Vehicles	72.4
Abandoned Vehicles	11.7
Crashes	11.5
Debris	1.9
Pedestrians	0.1
Fires	0.2

On freeways, the average incident frequency is normally estimated to be 40 per million vehicle miles of travel. When incidents occur, they frequently set off a vicious chain reaction, causing congestion, driver fatigue, driver impatience, driver frustration, and secondary incidents. Over the past few years, most of the large metropolitan areas have developed an incident management program designed to detect and remove incidents and restore the roadway capacity as quickly and safely as possible.

Electronic surveillance in the form of inductance loop detectors is the primary means of detection on most freeway management projects. Other information sources include the media, cellular telephone, police patrols, maintenance vehicles, service patrols, and fleet dispatchers. Incident verification is increasingly being done by Closed Circuit TV (CCTV), using solid state cameras.

This section identifies some of the useful signs to assist in avoiding primary or secondary incidents; identifying and responding to incidents when they do occur; and keeping the motorists apprised of the situation.

**Emergency Detour Signing**

A key component of incident management is to establish a clearly defined detour route to assist motorists around a crash, natural disaster, hazardous material spill, or other unplanned incidents. Detour routes need to be instituted in a timely manner to reduce delays, queues and the potential for secondary crashes. Emergency Detour Route signs will facilitate the driver in navigating around an incident providing these signs are consistent, conspicuous, and convey clear concise messages.

Therefore, all District Traffic Units shall have pre-established emergency detour route plans for roadway segments between every interchange on all limited access highways. Emergency detour routes shall be determined with input from but not limited to: PSP, County Emergency Management, local municipalities and emergency responders, and the Pennsylvania Turnpike Commission when applicable. After development and confirmation of the detour routes, the plan should be distributed to the key stakeholders.

Moreover, on a semi-annual basis, each District is to validate the detour plans, confirm roles and responsibilities for activations and deactivations, and exchange contact information. These semi-annual meetings may also serve other purposes such as discussing seasonal maintenance operations.

In order to implement an emergency detour route in a timely manner, Emergency Detour Color trailblazer (D15-1) signs shall be used at the end of off-ramps and in advance of all required turns and important decision points along the emergency detour route. Therefore, in addition to the trailblazers, the Emergency Detour – Follow (Color) Arrow (D14-1) sign should be erected on the off-ramp either as a hinged permanent sign installation, or placed on temporary supports on an as-needed basis.

If permanent folded signs are used, it is recommended that alternate messages be incorporated on the otherwise blank front side of the sign panel to make good use of supports and to avoid the “blank sign” appearance.

To develop statewide consistency in color usage, the following rule should be applied:

- Blue.....North Detour
- Red.....South Detour
- Green.....East Detour
- Black.....West Detour

Recognizing that most emergency detours routes have been established prior to this policy, conformance changes or modification will not be required. The above color pattern should be used for newly established routes, except if conflicts exist, alternate colors may be used.

Emergency Color detour signs may not be practical to implement on all detour routes due to confusion or conflicts with existing signing (e.g., confusion with Pittsburgh's colored beltway signing). Therefore, the following three types of alternatives may be used in lieu of color detour signs:

- 1) Additional "TO" routes – the interstate shield or route marker with a TO (M4-5 or M4-5-1) sign can be effective on directing motorists back to the interstate. This method is typically effective on simple parallel detour routes. Care must be taken to ensure that confusion with existing TO signs will not exist.
- 2) Changeable Message Signs (CMS) and Highway Advisory Radios (HAR) – the use of CMS and HAR may be a primary means of guiding motorist thru an emergency detour route. However, if temporary CMSs are used, a delay in positioning the devices will present a challenge. A dependable and systematic plan for activation and deactivation of temporary and/or permanent signs must exist. Refer to Sections [Changeable Message Signs](#) on page 2-108 and [Highway Advisory Radio Signs](#) on page 2-108 in this chapter for additional information concerning CMS and HAR.
- 3) Temporary Detour Signs – the timely deployment of temporary signs is a challenge. A dependable and systematic plan for activation and deactivation of signs must exist. Districts may address timeliness by:
  - Establishing a stockpile at a nearby location.
  - Erecting signs in the field in a covered or folded mode.
  - Erecting signs in the field in a meaningless or dormant mode.
  - Any combination of the above.

The above three options can only be used if colored detours cannot be practically implemented. Districts shall document their rationale for not using colored detours.

Incidents affecting a regional area, such as snowstorm, may require several interchanges or long sections of highway to be closed. Typically, an emergency regional detour will be communicated to motorists with ITS devices (CMSs, HARs, and Wizards) and notices to media outlets, trucking industry, adjacent states and Transcom. It is not prudent for the Districts to pre-establish detour routes for all logistical combination of regional impacts. However, Districts shall be prepared to spontaneously layout and establish a regional detour. It is also imperative that Districts have an ongoing inventory of ITS devices so devices can be readily deployed. The District Traffic Engineer or his/her designee should provide guidance on the emergency route layout, and County Maintenance shall have a plan for systematic deployment of ITS devices.

### Crash Investigation Site Signing

Although it is advantageous to have disabled vehicles moved from the roadway to the shoulder, additional benefits occur if vehicles can be moved to special crash investigation sites that are not visible from the mainline. These sites should accommodate vehicles involved in minor crashes in which vehicles can still be driven. The sites not only help alleviate traffic congestion, but also allow motorists to exchange insurance information in a safer environment.

Special signing to identify the location of these crash investigation sites should be included whenever these sites are available as part of the construction project.

### Emergency Cellular Telephone Signs

Cellular telephones have proven to have substantial benefits in establishing a highway incident detection system at minimum costs to highway agencies. Because of their effectiveness, it is desirable to enter into agreements with cellular telephone companies and the Pennsylvania State Police to establish a cellular telephone reporting system with a toll-free number, especially along freeways.

Emergency cellular Telephone Signs (D12-14) may be erected after each interchange when space permits. The end plaque may be used when motorists pass beyond the coverage area and the limited coverage plaque may be used in areas where reception is intermittent.

### Fire Hose Access Signs

Fire Hose Access Signs (D17-1) are very useful in helping the fire companies locate the location of hose connections at bridges and access doors through noise barriers. The signs should generally be oriented parallel to the direction of traffic flow.

### Changeable Message Signs

Changeable message signs may be effectively used to provide valuable information to motorists regarding incidents, estimated delay time and alternate routing. Even if motorists can not be rerouted, they will be more content if they are made aware of the specifics.

Due to the complex nature of many highway incidents, highway advisory radio can be used to supplement changeable message signs. Alternating messages such as "ACCIDENT AHEAD" and "TUNE 530 AM" can provide almost unlimited information for the motorists.

In order for changeable message signs to be effective, the importance of monitoring traffic conditions cannot be overemphasized.

### Highway Advisory Radio Signs

Highway Advisory Radio (HAR) is an alternative to changeable message signs. In order for HAR to be effective, HAR signs should be erected in advance of and at intervals within the range of the transmitted signal. The message broadcast on HAR must be transportation related. FHWA approval is required for the installation of HAR signs on the Interstate.

## 2.17 Welcome Center and Rest Area Signs

### General

Install Welcome Center, Parking Areas and Rest Area Signs in accordance with the standards in Publication 111 (see TC-8701P, TC-8701R, and TC-8701W).

### Supplemental Signs

Additional internal signs include the following:

- No Pets (A2-4)
- Pet Area (A2-4-2)
- Pet Area with Arrow (A-2-4-3)
- No Trespassing (A3-1)

- Roadside Rest Rules (A2-6-2)
- Recycling Services (I45-1)

## 2.18 Procuring Signs and Sign Accessories

### County Sign Inventory

#### Minimum Inventory.

The Department cannot afford the luxury of overstocked supplies, nor can the counties afford to be out of some of the most popular or critical signs. Therefore, a suggested list of some of the most popular and critical signs are included as [Exhibit 2-32](#). In most cases, the suggested reorder points for Storage Location 01 includes both a numerical value and a 2-month normal usage – the greater of these two values is the recommended “reorder point.”

#### Reorder Quantities.

“Reorder quantities” for Storage Location 01 should be similar to, but not greater than the reorder point.

#### Overstocked Items.

If a county has more than a 2-year supply of any sign or sign accessory, other counties in the district should be contacted to determine if any of the items could be transferred to them. If none of the counties in the District can use the overstocked item, Districts are encouraged to send an administrative message to all terminals, advising of the availability of the overstocked item.

If the excess stock continues, counties are encouraged to return overstocked items to the Sign Shop, except the Sign Shop will also not accept any obsolete items or signs with custom text. Although counties receive financial credit for items transferred to other counties, counties do not receive any direct credit for items returned to the Sign Shop. However, the Sign Shop recalculates the unit price of inventoried items at the Sign Shop, thereby passing the savings on to the next county that purchases one of the signs.

### Materials from the Sign Shop

Traffic signs and most sign accessories are generally available from the Sign Shop. However, SR plaques, cutout letter and occasionally some signs will be available thru contract. BOMO will determine where materials are to be procured and ensure that the necessary settings in Plant Maintenance are made.

#### Ordering Materials from the Sign Shop.

The Sign Shop provides signs for permanent sign installations, some work zone signs and other ancillary accessories. All materials are to be ordered through the SAP Plant Maintenance system. However, depending on the material, it may be ordered thru the sign inventory functional area as part of a sign work order or it may be necessary to order the material through the procurement area of SAP. Permanent signs that are inventoried as equipment records in Plant Maintenance may be ordered as part of the Sign Inventory Work Order process. Other commodities should be ordered via standard SAP procurement procedures. The Bureau of Office Services should be contacted with specific procurement questions not related to permanent signs ordered as part of a Sign Inventory Work Order.

When SAP Material Numbers exist for signs, preference should always be given to ordering signs by their specific numbers. Signs with custom text, including those with an “(x)” in the description column, have to be ordered using the SAP Plant Maintenance Sign Inventory Work Order Process with the custom information included in the long text (LT) field.

Occasionally, the District will need to include SignCAD drawings with the sign orders, but the county will order the sign in Plant Maintenance. To accomplish this, use the following procedures:

- a) The District creates a SignCAD drawing for the subject sign and places this in their District folder at [P:\bhste\\_shared\SignCAD\\_Files\\_for\\_Sign\\_Orders\District](P:\bhste_shared\SignCAD_Files_for_Sign_Orders\District)
- b) The District creates a notification for the subject sign equipment record. In the “Subject” screen area at the bottom of the notification the path to the specific SignCAD file is placed.
- c) The ACMM will subsequently create a Sign Inventory Work Order for the subject sign that will include linking the notification to the work order (using the IW3K transaction). The sign that requires the SignCAD file will be identified as one with an N (non-stocked) in the item category (IC) field. The file path must be manually copied from the “Subject” screen area of the notification to the item’s LT field on the component screen of the work order.
- d) The information contained in the LT field functions similar to the spec file in MORIS and is automatically copied into the Purchase Requisition and eventually the Stock Transport Order where it is visible for the Sign Shop.
- e) The Sign Shop will access the required SignCAD drawing in the folder specified for fabrication of the sign. The file will be deleted from the folder upon completion of the order so the District must save the original file in another folder elsewhere if they want it for future use.
- f) Orders that do not contain the necessary/sufficient information to properly fabricate the sign will be canceled. A notice of cancellation with explanation will be generated within SAP.

Some typical examples are shown in [Exhibit 2-33](#).

- a) When ordering City Name, Borough Name, Township Name, etc., double check the spelling in the LT field and ensure that spaces in the names are used when, and only when, the name is more than one word.
- b) If a sign does not have its own SAP Material Number, it should be order as a R99 1 or W99 1 sign if it is a standard-size regulatory or warning sign, or otherwise as a D5 sign.

#### Types of Sign Fabrication.

Signs may use any of the following substrates:

1. Flat sheet aluminum.
2. Flat sheet aluminum with extruded aluminum stiffeners (all Exit Gore signs and D5-series signs larger than 96"x48").
3. Fiberglass (SR paddles only).

Sign messages may be created by any of the following methods:

1. Silk-screened message and border (e.g., DO NOT PASS, Turn, Curve, Crossroad, signs, etc.).
2. Silk-screened background (reverse-screened, e.g., STOP, YIELD, DO NOT ENTER signs).
3. Cut-out legend and border (e.g., used on custom-made signs such as destination signs, where the legend is usually cut by a computerized sign maker).
4. Electronic cuttable film with the message cut from the sheet and applied to a covered blank.



5. Combination of silk-screening and cut-out legend (e.g., used on many Weight Limit signs, most Route Marker signs, etc., where most of the sign message is silk-screened and the numerals are applied by hand).

Identification of Sheeting Materials and Time of Manufacture.

Each sign manufactured at the Sign Shop has a code to identify the year and quarter of the year that the sign was made and the manufacturer and class of reflective sheeting. On silk-screened signs, this information is typically screened near the border on the lower half of the signs. On signs made with cut-out legend, one sticker is generally applied – one in the lower left corner of the sign.

The code for the year is the last two digits of the year, e.g., 07, 08, 09, 10, etc., (only the last digit was used on silk-screened signs prior to 1980 and on custom-made signs prior to 1986). The letters A, B, C and D represent the first, second, third and fourth quarters of the year. The reflective sheeting manufacturer is identified by the following symbols:

<u>Manufacturer</u>	<u>Symbol</u>
Nippon	■
3M	●
Avery Denison	◆

Materials Available From Statewide Contracts.

**Legacy**

**Contract No.**

**Title**

9550-10	Posts and Accessories (channel bar posts, steel square posts, wood post sleeves, W-beam posts and breakaway hardware and anti-theft bolts).
9905-09	Delineation Devices (post-mount guide rail delineators, web-mount guide rail delineators, top-mount mount barrier delineators, side-mount barrier delineators, and temporary non-plowable chip seal markers).
9905-11	Work Zone Traffic Control Devices (traffic cones, drums, and temporary pavement marking tape).
9905-13	Traffic Signs (primarily used for cutout letters and SR blanks).

**Exhibit 2-32 Suggested County Sign Safety Stock**

Nomen- Clature	Size	Description	Safety Stock Quantity
R1-1	30x30	Stop	6 signs or 3 mo.
R1-2	36x36	Yield	2 signs or 3 mo.
R2-1(35)	24x30	Speed Limit (35)	2 signs or 2 mo.
R2-1(40)	24x30	Speed Limit (40)	3 signs or 2 mo.
R2-1(45)	24x30	Speed Limit (45)	2 signs or 2 mo.
R4-1	24x30	Do Not Pass	2 signs or 2 mo.
R4-7	24x30	Keep Right	3 signs or 2 mo.
R5-1	30x30	Do Not Enter	1 sign or 3 mo.
R5-1	36x36	Do Not Enter	1 sign or 3 mo.
R5-9	36x24	Wrong Way	1 sign or 3 mo.
R6-1(R)	36x12	On Way Right	2 signs or 2 mo.
R6-1(L)	36x12	On Way Left	2 signs or 2 mo.
R8-3A	24x24	No Parking Symbol	1 sign or 2 mo.
R11-2	48x30	Road Closed	1 sign or 2 mo.
R12-1	24x30	Weight Limit 10 Tons	4 mo.
R12-1	24x30	Weight Limit ( ) Tons	4 mo.
R12-1-2	24x12	Bridge	4 mo.
R12-1-1	24x18	( ) Mile Ahead	4 mo.
R12-4	24x18	Except Combinations ( ) Tons	4 mo.
W1-1R	30x30	Right Turn	2 signs or 2 mo.
W1-1L	30x30	Left Turn	2 signs or 2 mo.
W1-2R	30x30	Right Curve	2 signs or 2 mo.
W1-2L	30x30	Left Curve	2 signs or 2mo.
W1-4R	30x30	Right Reverse Curve	1 sign or 2 mo.
W1-4L	30x30	Left Reverse Curve	1 sign or 2 mo.
W1-6	48x24	Large Arrow (Single)	2 signs or 2 mo.
W1-8	18x24	Chevron Alignment Marker	3 signs or 2 mo.
W1-8	24x30	Chevron Alignment Marker	3 signs or 2 mo.
W2-1	30x30	Cross Road	2 signs or 2 mo.
W2-2	30x30	Side Road	2 signs or 2 mo.
W2-4	30x30	T Symbol	2 signs or 2 mo.
W3-1A	36x36	Stop Ahead	2 signs or 3 mo.
W3-5	36x36	Speed Reduction (40)	1 sign or 2 mo.

Nomenclature	Size	Description	Safety Stock Quantity
W3-10	48x36	No Passing Zone Pennant	2 signs or 2 mo.
W5-2A	30x30	Narrow Bridge-Underpass Sym.	2 signs or 2 mo.
W13-1(20)	18x18	Advisory Speed (20)	1 sign or 2 mo.
W13-1(25)	18x18	Advisory Speed (25)	1 sign or 2 mo.
W13-1(30)	18x18	Advisory Speed (30)	1 sign or 2 mo.
W13-1(35)	18x18	Advisory Speed (35)	1 sign or 2 mo.
W13-1(40)	18x18	Advisory Speed (40)	1 sign or 2 mo.
W16-1	18x18	Hazard Marker	3 signs or 2 mo.
W16-2R	12x36	Right Clearance Marker (B & Y)	5 signs or 2 mo.
W16-2L	12x36	Left Clearance Marker (B & Y)	5 signs or 2 mo.
W16-103P	24x18	Distance Ahead Plaque	4 mo.
W21-7	36x36	Work Area Ahead (Plastic)	1 sign or 2 mo.
W21-10	24x24	Stop and Slow Paddle	1 sign or 2 mo.
M2-1	21x15	Junction Marker (B & W)	1 sign or 2 mo.
M3-1	24x12	Card Direct Marker North	2 signs or 2 mo.
M3-2	24x12	Card Direct Marker East	2 signs or 2 mo.
M3-3	24x12	Card Direct Marker South	2 signs or 2 mo.
M3-4	24x12	Card Direct Marker West	2 signs or 2 mo.
M6-1	21x15	Directional Arrow 90 Deg.	2 signs or 2 mo.

\* In addition, stock a 4-month supply of pressure-sensitive legend for these partially finished signs.

Exhibit 2-33 Ordering Custom Signs

Nomen-Clature	Sign Name	Example
R1-3	(X) WAY	2 WAY
R2-2-1	TRUCKS OVER (X) LBS SPEED (X)	10,000 LBS SPEED 15
R4-6	TRUCK LANE (X) FEET	1500 FEET
R12-1	WEIGHT LIMIT (X) TONS	12 TONS
R12-1-1	(X) MILES AHEAD	3 MILES
R14-16-1	VEHICLES OVER (X) PROHIBITED	10' WIDE
W1-5-1	WINDING ROAD NEXT (X) MILES	5 MILES
W5-1-1	NARROW ROAD NEXT (X) MILES	5 MILES
W12-2	LOW CLEARANCE (X)' (X)"	13' 2"
W16-103P	DISTANCE AHEAD PLAQUE	3 MILES
W99-1	W99-1 SPECIAL WARNING	Curve sign with Unusual Side Road Geometry
D1-1	SINGLE LINE DESTINATION	LA SCRANTON 10 *
D1-2	DOUBLE LINE DESTINATION	SAA COLUMBIA 15 * YORK 12 RA **
D2-1	DOUBLE LINE DISTANCE	YORK 9 HARRISBURG 36 **
D5	72" X 60" SPECIAL DIRECTIONAL	EXIT 13 WITH RIGHT DIAGONAL
D10-4	ENHANCED INTERMEDIATE DISTANCE MARKER	WEST, US 12, MILE 221
I10-1	CITY NAME	PITTSBURGH
I10-5	COUNTY NAME	LACKAWANNA

\* SAA = straight-ahead arrow, LA = left arrow, RA = right arrow,  
LDA = left diagonal arrow, RDA = right diagonal arrow.

\*\* Put signs second-line message in second line of the spec file instructions. Similarly, put the third-line message of a three-line sign in third line of the spec file instructions

## 2.19 Chapter 2 Appendix

### Proposed Traffic Route Change

\_\_\_\_\_ County  
 Proposed Relocation of PA \_\_\_\_\_

\_\_\_\_\_, Director  
 Bureau of Maintenance and Operations  
 ATTN: Chief, Traffic Engineering and Operations Division

District Executive  
 Engineering District \_\_\_\_\_

In order to eliminate traffic congestion and improve traffic flow through \_\_\_\_\_, we are recommend the partial elimination and the partial relocation of PA \_\_\_\_\_. This action would move PA \_\_\_\_\_ from a predominantly commercial area.

This change would take effect immediately upon securing the necessary approvals and delivery and installation of the necessary signing.

<u>Co. / SR</u>	<u>From Segment / Offset</u>	<u>Intersection</u>	<u>To Segment / Offset</u>	<u>Intersection</u>
<b>Partial Elimination of _____</b>				
48 / 0412	0020 / 0032	SR 3002	0070 / 0016	SR 3008
<b>Partial Relocation of _____</b>				
48 / 3002	0100 / 0012	SR 0412	0140 / 0492	SR 3008
<u>Northbound</u>				
48 / 3008	0030 / 0082	SR 3002	0030 / 0497	SR 1001
48 / 1001	0100 / 0025	SR 3008	0230 / 0063	SR 2010
<u>Southbound</u>				
48 / 1001	0231 / 0065	SR 2010	0101 / 0028	SR 3008
48 / 3008	0031 / 0499	SR 1001	0101 / 0025	SR 3002

Also enclose the following: (1) a listing of the physical limitations of the roadways for the proposed partial relocations; and (2) either one reproducible map graphically showing the location of the proposed partial elimination or partial relocation, or nine color-coded originals.

Enclosures \_\_\_\_\_

**Physical Limitations of the Proposed Traffic Route**

Date \_\_\_\_\_

County \_\_\_\_\_

Traffic Route No. \_\_\_\_\_

ESTABLISHMENT \_\_\_\_\_

EXTENSION \_\_\_\_\_

RELOCATION \_\_\_\_\_

<b>SR / segment →</b>				
<b>ROAD WIDTH</b>				
Roadway				
Berm				
Overall				
<b>BASE</b>				
Depth				
Type				
<b>SURFACE</b>				
Type				
Designation				
<b>BRIDGE RESTRICTIONS</b>				
Width (min.)				
Load (min.)				
<b>OVERPASS</b>				
Clearance				
<b>CURVES</b>				
No. over 6-degree				
Maximum				
<b>GRADES</b>				
No. over 6%				
Maximum length				

Does this route

(a) Save Mileage Distance? Yes \_\_\_ No \_\_\_ If yes, how much mileage? \_\_\_\_\_

(b) Re-route a present route? Yes \_\_\_ No \_\_\_

Is the complete route over State Highways? Yes \_\_\_ No \_\_\_ If no, an agreement(s) must be executed and enclosed.

Is the proposed route properly marked with signs and pavement markings? Yes \_\_\_ No \_\_\_

Submitted by \_\_\_\_\_ Date \_\_\_\_\_  
(District Traffic Engineer)

Approved by \_\_\_\_\_ Date \_\_\_\_\_  
(District Executive)

**Municipal Agreement re Traffic Route Change**

THIS AGREEMENT, made this \_\_\_\_\_ day of \_\_\_\_\_, 20\_\_\_\_, between the Commonwealth of Pennsylvania, acting through the Department of Transportation, hereinafter called the COMMONWEALTH,

and

\_\_\_\_\_

hereinafter called the MUNICIPALITY.

WITNESSETH:

WHEREAS, the parties desire to designate certain highways under the jurisdiction of the MUNICIPALITY as traffic routes; and,

WHEREAS, the parties desire to have such traffic routes established and marked in accordance with standards, policies and regulations of the COMMONWEALTH's Department of Transportation; and,

WHEREAS, the parties desire to enter into this Agreement for the purpose of outlining their respective obligations.

NOW, THEREFORE, the parties agree to the following:



1. Following highways under the jurisdiction of the MUNICIPALITY are hereby established as traffic routes.

<u>Via</u>	<u>From Intersection</u>	<u>To Intersection</u>	<u>Direction</u>	<u>Traffic Route No.</u>
------------	--------------------------	------------------------	------------------	--------------------------

These routes are more specifically shown on a map which is attached as Exhibit A and made a part of this Agreement. The establishment and maintenance of these traffic routes shall be subject to the conditions set forth below.

2. The MUNICIPALITY shall, at its cost, be responsible for policing and maintaining the roadway and provide for snow removal.

3. The COMMONWEALTH shall provide and maintain all traffic route markers. The MUNICIPALITY shall, at its cost, be responsible for providing and maintaining all other traffic-control devices including pavement markings.

4. The COMMONWEALTH's Secretary of Transportation shall have the right, in his/her sole discretion, to discontinue any or all of the above highways under the jurisdiction of the MUNICIPALITY as traffic routes. In the event that any such determination is made, the COMMONWEALTH shall remove all signs and markings indicating the highway to be a traffic route.

5. The MUNICIPALITY shall indemnify, save harmless and defend COMMONWEALTH, the Department of Transportation, their officers, agents and employees, from all suits, actions or

claims of any character, name or description, brought for or on account of any injury, death or property damage as a result of the design, construction and/or maintenance of the above-noted highways, whether the same be due to the use of defective materials, defective workmanship, neglect in the MUNICIPALITY and/or the MUNICIPALITY's contractor, their officers, agents and employees during the performance of any work on the above-noted highways under the jurisdiction of the MUNICIPALITY.

6. If the MUNICIPALITY shall fail to perform any of its obligations under this Agreement, and if the COMMONWEALTH desires to continue any or all of the above-noted highways as traffic routes, and the MUNICIPALITY shall fail to cure any defaults and performance within thirty (30) days of notice from the COMMONWEALTH, the MUNICIPALITY authorizes the COMMONWEALTH to withhold so much of the MUNICIPALITY's Liquid Fuels Tax allocation as may be necessary to complete necessary work and/or to reimburse the COMMONWEALTH in full for all costs incurred, and does hereby and herewith authorize the COMMONWEALTH to withhold such amount and to apply such funds, or portions thereof, to remedy such default.

7. The MUNICIPALITY agrees to be bound by the Act of May 20, 1937, (P.L. 728, No. 193), as amended by Act of October 5, 1978, (No. 260), which provides, in substance, that the Board of Claims shall have jurisdiction of claims against the COMMONWEALTH arising from contracts and the power to order the interpleader or impleader to other parties when necessary for a complete determination of any claim or counterclaim in which the COMMONWEALTH is a party.

IN WITNESS WHEREOF, the parties have executed this Agreement on the date first above written.

ATTEST

COMMONWEALTH OF PENNSYLVANIA  
DEPARTMENT OF TRANSPORTATION

\_\_\_\_\_ BY \_\_\_\_\_  
Deputy Secretary of Transportation

(SEAL)

ATTEST:

\_\_\_\_\_ Title \_\_\_\_\_

(SEAL)

APPROVED AS TO LEGALITY AND FORM

BY \_\_\_\_\_  
Chief Counsel

BY \_\_\_\_\_  
Deputy Attorney General

\* Resolution designating signature authority attached.

**Resolution Designating Signature Authority**

BE IT RESOLVED, by authority of the \_\_\_\_\_  
(Name of governing body)

\_\_\_\_\_ of the \_\_\_\_\_,  
(Name of Municipality)

\_\_\_\_\_ County, and it is hereby resolved by authority of the same,

that the \_\_\_\_\_ of said Municipality Authority be authorized and  
(designate official title)

directed to sign the attached Agreement on its behalf and that the \_\_\_\_\_  
(designate official title)

be authorized and directed to attest the same.

ATTEST \_\_\_\_\_  
(Name of Municipality)

\_\_\_\_\_  
(Signature and designation of official title) By: \_\_\_\_\_  
(Signature and designation of official title)

(SEAL)

I, \_\_\_\_\_,  
(Name) (Official Title)

of the \_\_\_\_\_, do hereby certify that the  
(Name of governing body and municipality)

foregoing is a true and correct copy of the Resolution adopted at a regular meeting of the

\_\_\_\_\_, held the \_\_\_\_\_ day of \_\_\_\_\_, 20\_\_.  
(Name of governing body)

DATE \_\_\_\_\_  
(Signature and designation of official title)

## CHAPTER 3 - MARKINGS

### 3.1 General

#### Purpose

Markings are a common and expected component of the highway system. The primary purpose of markings is to provide the driver clear visual information to operate his vehicle in a variety of situations. Markings define the intended travel path during both daylight and nighttime hours, and during various weather conditions. Common types include the following:

- Pavement markings (includes lines, words, symbols, pavement markers, and curb markings).
- Object markings.
- Delineators.
- Barricades, channelizing devices, and islands.

Markings also perform a function in the overall traffic-control system. In general, markings supplement other traffic control devices and provide guidance and warning. However, in accordance with [§3307\(b\)](#) of the Vehicle Code, they also perform a regulatory function because no-passing zone pavement markings are required in addition to signs to enforce no-passing zones.

As with all traffic-control devices, markings should be readily recognized and understood.

#### Laws, Regulations and Other Publications

*Americans with Disabilities Act and Architectural Barriers Act Accessibility Guidelines*, United States Access Board, July 23, 2004. Available online at <http://www.access-board.gov/ada-aba/final.pdf>.

*Approved Construction Materials – Bulletin 15 (Publication 35)*. A listing of PennDOT approved materials and manufacturers.

*Guide to Roundabouts (Publication 414)*. This PennDOT publication is designed as a supplement to FHWA's *Roundabouts: An Informational Guide* to supplement existing design policies and procedures. The publication is available online at <ftp://ftp.dot.state.pa.us/public/PubsForms/Publications/PUB%20414.pdf>.

**Note: PennDOT adopted NCHRP Report 672 as the Roundabout Guide**  
(<http://www.trb.org/Main/Blurbs/164470.aspx>).

*Manual on Uniform Traffic Control Devices (MUTCD)*. A manual adopted by the Federal Highway Administration and which establishes national guidelines for traffic-control devices, including signs. The *MUTCD* is available through the Superintendent of Documents, U.S. Government Printing Office, Washington D.C. Specifically, Part 3 addresses pavement markings, and is available at <http://mutcd.fhwa.dot.gov/>.

*Pavement Marking Handbook*. This PennDOT manual provides detailed guidance for Department work force in the day-to-day operation of the Department's pavement marking program, including the operation of the truck-mounted and small paint machines.

*Pennsylvania Drivers Manual*. This manual provides guidance for drivers, including the purpose and meaning of the various types of markings, available at [http://www.dmv.state.pa.us/drivers\\_manual/index.shtml](http://www.dmv.state.pa.us/drivers_manual/index.shtml).

*Roundabouts: An Informational Guide*, Pub. No. FHWA RD 00 067, June 2000 (FHWA) – available online at <http://www.tfhrc.gov/safety/00-0671.pdf>.

*Specifications (Publication 408)*. Specifications referenced for all Department construction projects, which includes requirements for the installation of signs and sign accessories. Specifically, Sections 961, 962, 963, 964 and 965 address pavement marking materials and delineation devices. Pub. 408 is also available at <http://www.dot.state.pa.us/Internet/Bureaus/pdDesign.nsf/ConstructionSpecs408and7?OpenForm>

*Traffic Control – Pavement Markings and Signing Standards (Publication 111)*. This publication includes PennDOT's 8600 and 8700-series standards. Specifically, the 8600-series deal with markings: the types, dimensions, and locations of pavement markings (TC-8600), snowplowable raised pavement markers (TC-8602), and delineators (TC-8604). The publication is available at <ftp://ftp.dot.state.pa.us/public/PubsForms/Publications/PUB%20111M.pdf>

*Vehicle Code (75 Pa. C.S.)*. The Pennsylvania Vehicle Code is law that typically defines actions required by drivers and the Department. It discusses markings in several sections, but of specific importance is the requirement in [§3307\(b\)](#) that both signs and markings are required to enforce no-passing zones.

*Work Zone Traffic Control (Publication 213)*. This publication shows drawings for temporary traffic control, including the use of temporary pavement markings.

## Definitions

The following words and terms, when used in this chapter, have the following meanings, unless the context clearly indicates otherwise:

*Delineator* – A retroreflective device mounted on the road surface or at the side of the roadway in a series to indicate the alignment of the roadway, especially at night or in adverse weather.

*Divided highway* – A highway divided into two or more roadways and so constructed as to impede vehicular traffic between the roadways by providing an intervening space, physical barrier or clearly indicated dividing section.

*85th percentile speed* – The speed on a roadway at or below which 85 percent of the motor vehicles travel.

*Expressway* – A divided arterial highway for through traffic with partial control of access and generally with grade separations at major intersections.

*Freeway* – A limited access highway to which the only means of ingress and egress is by interchange ramps.

*Narrow bridge or underpass* – A bridge, culvert or underpass with a two-way roadway clearance width of 16 to 18 feet, or any bridge, culvert or underpass having a roadway clearance less than the width of the approach travel lanes.

*School zone* – A portion of a highway that at least partially abuts a school property or extends beyond the school property line that is used by students to walk to or from school or to or from a school bus pick-up or drop-off location at a school.

## 3.2 Pavement Markings

Pavement markings are the only traffic control device that is visible without the driver taking his or her eyes off the roadway. Since pavement markings are on the physical road surface, they are superior to all other markings in showing the intended travel path. Quality pavement markings also make drivers feel more comfortable and reduce their stress level.

The Department’s Pavement Marking Handbook (Pub 648) is the primary document for Department personnel that are directly involved with the operation of the Truck-Mounted Paint Machine Program and the Small Paint Machine Program. The handbook gives detailed guidance on how to run the Department’s in-house program.

### Pavement Marking Materials

This section provides a brief description of the various marking materials that are approved and available for use in Pennsylvania. The Materials and Testing Division conduct the testing of these materials on the Department’s test deck and in the laboratory, with the assistance of the Traffic Engineering and Operations Division.

The only materials that can be sold for or used on any public highways in Pennsylvania are those materials listed in *Bulletin 15 (Publication 35)*. **Exhibit 3-1** lists materials used in Pennsylvania and appropriate cross-references.

**Exhibit 3-1 Pavement Marking Materials**

Material	Section in Publication 408	Section in Publication 35
Hot thermoplastic	960	960
Cold plastic	961	961
Waterborne paint	962	962
Epoxy markings	964	964
Preformed thermoplastic	965	965
Snowplowable RPMs	966	966
Glass beads for traffic paint	1103.14	1103.14
Methyl methacrylate	*	Miscellaneous: Traffic Division
Polyurea	*	
Polyester	*	
Wet reflective tape	*	

\* Specifications are on file with the Traffic Engineering and Operations Division

Pavement marking materials are further described as follows:

1. **Waterborne Traffic Paint.** Waterborne Traffic Paints (white and yellow) is the most common type of pavement marking used in Pennsylvania. This paint is pre-heated prior to application, applied by truck-mounted paint equipment for center, lane and edge lines, and normally dries in 90 seconds or less.
2. **Glass Beads.** Since there are various marking materials approved for use in the state, the Department has developed specifications for several types of beads for use with these materials. To view the gradation of the following bead types, go to Publication 408, Section 1103.14.
  - **Type A Beads.** These are the standard beads specified in AASHTO M-247, Type I, Moisture Resistant. Type A Beads can be used with all marking materials.

- Type B Beads. This gradation is much larger than the standard beads (Type A), and was developed for use with durable materials to provide better wet-night visibility of the pavement markings. Commercially available trade names include Visibeads, Big Beads, Megalux, etc.
  - Type C Beads. These beads are another large gradation similar to the Type B Beads, but are used primarily with waterborne and polyester pavement marking materials for improved wet-night visibility.
  - Type D Beads. This gradation is only slightly different from the standard beads (Type A) with a greater percentage of beads in the bigger sieve sizes. Type D Beads may be used with waterborne paints as an alternate to Type A Beads.
3. Hot Thermoplastic. Hot thermoplastic material is generally a synthetic resin that softens when heated and hardens when cooled without changing the properties of the material. Although the material contains glass beads, an additional coating of beads is applied after installation to provide initial reflectivity. Hot thermoplastic material can be applied by screed, ribbon or spray methods. A sealer should be used on concrete and old bituminous roadways immediately prior to application of the thermoplastic. Existing marking materials should be removed for proper adherence to the roadway.
4. Cold Plastic Tape and Legends. This material is pre-formed and is white or yellow in color, has pressure-sensitive adhesive on its back surface, and is capable of being applied to bituminous and/or concrete roadway surfaces. These materials can be surface-applied or inlaid. If surface applied, a sealer will generally be required. Purchase materials via the Pavement Marking Legend Contract (No. 9905-04).

This material is further classified into the following two categories, and each has its own specifications:

- Cold plastic pavement marker or legend. This has an adhesive back and is 60 mils or 90 mils thick. This material is usually considered to be of the permanent type.
- Temporary pavement marking tape. This has an adhesive back and is from 20 to 50 mils thick. Temporary tape comes as:
  1. Non-removable.
  2. Removable, Type I.
  3. Removable, Type II.

The discerning difference between removable Type I and Type II tape is that Type II tape does not leave a discernible mark on the highway 30 days after its removal.

5. Epoxy. This material is a two-part, 100 percent solids system, which contains resins and a catalyst, and can be hot-spray applied after mixing. It is a very durable material that can be applied to both bituminous and concrete pavement after the roadway surface is thoroughly cleaned of old pavement markings or curing compound.
6. Preformed Thermoplastic. This material is a preformed polymer thermoplastic (white or yellow) with glass beads uniformly distributed throughout its cross section, and used on bituminous and concrete pavements. This material is surface applied, and usually fused in place by a propane torch. Purchase materials via the Pavement Marking Legend Contract (No. 9905-04).



7. Methyl Methacrylate. This material is a two-part compound which can be extruded, sprayed or manually applied to either concrete or bituminous pavements. It contains both glass beads and anti-skid aggregate. Existing marking materials should be removed for proper adhesion.
8. Polyurea. Polyurea-based liquid pavement marking material consists of a two-component, 100 percent solid, thermosetting material. Limited experience indicates that it is a durable pavement marking material that dries to no-track in 3 to 8 minutes at all temperatures down to about 40 degrees.
9. Polyester. Polyester is a two-component system (resin and catalyst) which is applied separately on the roadway and cures to a durable marking. It can be applied to both concrete and bituminous pavements but has not performed well on concrete. It should not be applied to new bituminous surfaces until the surface oils have disappeared (approximately 2 weeks). It can be applied over old markings.
10. Wet Reflective Striping Tape. This material is a highly reflective tape under both dry and wet roadway conditions, even when fully submersed in water. There are two types of wet reflective striping tape – “temporary” for work zones and “permanent” for normal applications.
11. Pavement Markers. Pavement markers are used as positioning guides in conjunction with other longitudinal markings without conveying information to the motorist as to passing or lane use restrictions. Their purpose is to provide delineation during darkness and/or adverse weather conditions that may render other pavement markings ineffective. These markers are available as either one-way or two-way markers depending on the number of reflective faces. In addition, there are two basic models:
  - Temporary raised pavement markers (TRPMs).
  - Snowplowable raised pavement markers (RPMs).

There are also recessed markers, but these are not for new installations.

Waterborne paint with glass beads is the most popular pavement markings used in United States. This is the least expensive of the materials used today, but unfortunately, despite improvements in durability, it is generally the least durable of all pavement-marking materials.

Some materials are more durable than other materials, but not all materials are compatible with each other or with some road surfaces. [Exhibit 3-2](#) shows material compatibility between existing and new striping materials.

**Exhibit 3-2 Material Compatibility for Restriping**

Original Material	New Material					
	WB Paint	Thermo	Tape	Epoxy	MMA	Polyurea
WB Paint	Y	Y	N	Y*	N	N
Thermo	Y	Y	N	N	N	N
Tape	N	N	N	N	N	N
Epoxy	Y	Y	N	Y**	-	-
MMA	Y	Y	N	-	Y	-
Polyurea	Y	Y	N	-	-	Y

\* Epoxy may be applied over existing waterborne paint if the waterborne paint was applied at a wet-film thickness of 9 mils or less, or if the existing waterborne paint has a durability rating of "5" or less.

\*\* Only one restripe with epoxy.

**Black Contrast Markings**

White epoxy pavement markings are not as white as most other white materials, and because of this, they are frequently difficult to see on Portland cement roadways during some daylight conditions. Therefore, a recommended procedure is to apply black epoxy, flooded with black aggregate to make the white markings stand out. For skip lines, crews can apply a black line immediately after the white skip lines, using the same dimensions for both colors. Another method used in some states, is to place an 8-inch wide line as the background material and then apply the white marking over the black marking.

Black epoxy should satisfy color chip 37038 of Federal Standard 595B, and have similar quality as the white epoxy pavement markings.

**Minimum Retroreflectivity**

In 1993, Congress directed the U.S. Secretary of Transportation to revise the *MUTCD* to include minimum levels of retroreflectivity for traffic signs and pavement markings. Since then, FHWA has sponsored extensive research on the retroreflectivity needs of drivers for both signs and pavement markings, but unlike traffic signs, FHWA has not adopted or even officially proposed minimum values for pavement markings.

Recent research indicates that minimum, maintained retroreflectivity values for both white and yellow pavement marking should be between 80 and 100 mcd/m<sup>2</sup>/lux on high-speed roadways. However, maintaining a minimum retroreflectivity for pavement markings will be difficult for the following reasons:

1. Markings are typically "manufactured" on location under varying temperature and humidity conditions, applied over existing surfaces that may be less than ideal (e.g., rough texture due to surface treatment, oil contaminants, etc.), and traffic sometimes drive on or cross over the markings before they are cured, all of which affect the initial retroreflectivity.
2. The retroreflectivity of some line segments deteriorate much faster than other segments because vehicles frequently run on the lines in heavy weaving areas, around curves, and at intersections. In

addition, asphalt roadways sometime bleed and the asphalt material may track onto the pavement markings, causing permanent discoloration and loss of retroreflectivity.

3. Snowplows, sanding, chemicals, anti-skid materials, and tire studs and chains cause markings to deteriorate very quickly during the winter months.
4. If lines wear out during the winter, it may not be practical to replace them for several months.

Therefore, all of the above will be major concerns when FHWA proposes their minimum retroreflectivity recommendations. Currently, the Department does not have any minimum retroreflectivity requirements for its paint program. (The Department has, however, established minimum values for newly-applied pavement marking materials in Publication 408.)

### Durable Pavement Markings

Waterborne paint is the most common pavement marking material, but it also degrades faster than most other materials. Therefore, highway agencies use the expression “durable pavement marking” to describe those products that typically last much longer. In general, the term encompasses hot thermoplastic, cold-preformed thermoplastic, epoxy, tape, polyester, polyurea, and methyl methacrylate (MMA).

While it may be desirable to use durable pavement markings on all expressways, freeways and NHS highway projects, Districts can decide if durable pavement markings will be used and on which roadways. Each District will fund all durable pavement markings from their normal funding sources.

Since waterborne paint is generally the most cost-effective pavement marking material, the real question is, “Will the paint line still be in place and the retroreflectivity consistently above the ‘minimum’ acceptable values when the Department is able to repaint the lines?” If the answer is “yes,” then waterborne paint may be the best option.

### Pavement Markings in Construction and Resurfacing Projects

Contractors are required to mix all waterborne paints prior to using them. If other types of marking materials are used, the contractor should handle those materials as specified by the manufacturer. The line-painting equipment shall be calibrated to apply the pavement marking material at the correct application rate as required in the specifications and the quality verified by applying the marking materials as test stripes on sample plates prior to installing the actual lines.

Construction inspectors are to use the “Pavement Markings, Construction Inspector Quality Assurance Review Form” as included in the [Chapter 3 Appendix](#), page 3-16.

### Raised Pavement Markers

Raised Pavement Markers (RPMs) provide important guidance to motorists at night, particularly when the roadway is wet and longitudinal pavement markings lose their effectiveness. Customer service surveys have also indicated that motorists like RPMs.

Based on research, the only acceptable permanent RPMs for new installations are the snowplowable, low-profile type that installed in a holder and listed in Publication 35. Districts with reflectors in recessed slots may continue to install replacement reflectors for the life of the slots.

The Department has established the following guidelines:

1. Install RPMs on the lane lines and within exit-ramp gore areas of all Interstate highways, freeways, and expressways. (An exception may occur if the pavement is in poor condition and will not accommodate RPMs, or if the Department plans to resurface the pavement within 4 years.)
2. As funding is available, install RPMs on high-volume NHS roadways, and on sections of other roadways where there is a higher-than-normal incidence of nighttime run-off-the-road crashes.
3. Install bridge-deck RPMs on all bridges that are 200 feet or longer in length when RPMs are on the adjacent sections of roadway.

Over the past 15 years, the Department has deployed a significant number of RPMs. Therefore, it is important to manage these devices in an effective and efficient manner such that they continue to provide effective guidance to motorists.

Design and installation details for RPMs are in Pavement Marking Standard TC-8602 and in Section 966 of Publication 408.

#### Acceptability Criteria

One difficulty in managing these devices is the typical need to rely on a subjective rating system to determine replacement. To assist in this evaluation, each District is to consider RPMs acceptable if all of the following apply:

- At least 50 percent of the reflective surface is visible at night.
- At least 90 percent of RPMs exist and are visible at night.
- On expressways and freeways, at least five RPMs are continuously visible at night using low beams.

Since most damage to RPMs occurs over the winter months, the level of replacements should be determined during the April to May timeframe each year, which generally results in a need to add or replace lenses on a cyclical basis, e.g., every 2 years.

#### RPM Inventory

Each District should maintain an RPM inventory and management system, and BOMO will develop a statewide database that will be the ultimate repository for these files.

#### Legislative Mandate and Annual Reporting

The Department's annual budget typically has a line item that requires the Department to spend about \$4 million for RPMs. Further, the Department is normally required, on an annual basis, to report the expenditures to the House and Senate Transportation Committees.

To satisfy the legislative mandates, on an on-going annual basis, Districts should annually develop their RPM program as follows:

1. By late summer, the Deputy Secretary for Highway Administration will advise each District of their funding level for the fiscal year and the appropriate contact person in the Center for Program Development and Management.
2. Districts should develop a program designed around the funding that they receive. When preparing cost estimates, use current costs for each new unit (holder with reflector) and replacement reflector. Also, include items for the engineering and construction inspection
3. By February 28, the District's Planning and Programming Engineer/Manager should create a new project in MPMS for their RPM program. The District should forward the newly created MPMS numbers to the appropriate contact person in the Center for Program Development and

Management. When creating the project, the Project Class is “*Safety Improvement*” and the Improvement Type is “*Reflective Pavement Markers (HWYRPM)*.” These RPM projects are 100 percent federally funded.

4. By June 15, each District should obligate the approved amount. After that date, Central Office will redistribute any money that is not obligated.

### Stop and Yield Lines

Section 3B.16 of the *MUTCD* discusses the placement of stop and yield lines. However, some common mistakes are placing the line too far from an intersecting roadway where drivers do not have a clear view of approaching traffic, and locating the stop line directly across from the STOP sign.

In order to better clarify the use and placement of stop lines at stop-controlled intersections, consider the following:

1. Stop signs and stop lines are separate traffic control devices and should be engineered independent of each other. Stop lines are not required to supplement the installation of every stop sign. If it is determined that conditions are such that stop lines are not necessary or are unlikely to enhance the safety of the intersection, eliminate them or do not install them.
2. Use stop lines where it is necessary to provide drivers with additional guidance as to where vehicles should stop, in compliance with the stop sign.
3. If using a stop line in conjunction with a stop sign, the normal position is in-line with the stop sign. However, if the stop sign cannot be located where vehicles are expected to stop (such as at wide-throat intersections), the stop line should be placed at the expected (desired) stopping point. Typically, this is as close to the edge of the intersecting roadway as possible where drivers have the best available sight lines.
4. Exact location of the desired stopping point should be determined in the field taking into account the various site-specific intersection parameters. Place stop lines no more than 30 feet or less than 4 feet from the nearest edge of the intersecting traveled way. When spotting the location of these lines, always consider the fact that a driver’s eyes are about 10 feet behind the stop or yield line and at an elevation of 3.5 feet above the road surface.
5. Stop lines should not encroach onto the shoulder of the intersecting roadway. If the expected (desired) stop line location is determined to fall within the shoulder area of the intersecting road, adjust the stop line placement accordingly so as not to encroach on the shoulder area.
6. Consider use of a dotted edge line to indicate the edge of the cartway where the intersecting road meets the approach (see [Exhibit 3-3](#)). This will provide the driver with a visual cue of where the intersecting travel lane begins. Districts can also use stop lines in conjunction with these dotted edge lines.

**Exhibit 3-3 Dotted White Edge Lines**

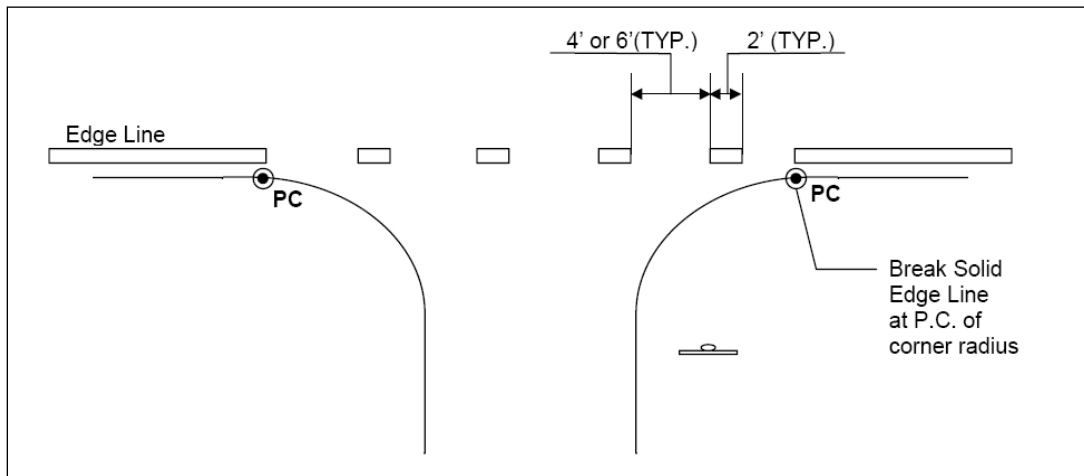

**Crosswalks**

Research of marked versus unmarked crosswalks at 1,000 locations in 16 states indicates that the risk of a pedestrian-vehicle crash is 3.6 times greater at uncontrolled intersections with marked crosswalk than with an unmarked crosswalk.<sup>1</sup> Therefore, Districts should use discretion when approving marked crosswalks at uncontrolled intersections.

Pavement Marking Standard Drawing TC-8600, Sheet 4 of 8, shows three types of crosswalk pavement markings. When crosswalks are used, coordinate with the local entity to determine the type of crosswalk marking. The minimum width of a crosswalk is 6 feet, as measured between any transverse markings.

Unsignalized mid-block crosswalks should be in accordance with Section 11.9. All crosswalks should be at approximately 90 degrees to the roadway. For added visibility, the crosswalk may be marked with wide white diagonal lines at a 45-degree angle to the crosswalk or with wide white longitudinal lines parallel to traffic in accordance with Pavement Marking Standard TC-8600.

Local authorities sometimes want to use decorative crosswalks, such as brick pavers, stampings, etc. Although not prohibited, Districts need to address funding and maintenance issues. Specifications for several types of decorative crosswalks are included in Publication 447, New Product Evaluation for Low Volume Local Roads, available at <ftp://ftp.dot.state.pa.us/public/PubsForms/Publications/PUB%20447.pdf>.

Districts may use yield lines in advance of unsignalized mid-block crosswalk. If used, place the yield lines 20 to 50 feet in advance of the crosswalk and install a Yield Here to Pedestrians (R1-5) sign immediately adjacent to the yield line (see Figure 3B-15 in the *MUTCD*). Yield lines should conform to Pavement Marking Standard TC-8600.

**Accessible Parking Spaces**

Section 208 of the Americans with Disabilities Act (ADA), 36 CFR Part 1191 (see <http://www.access-board.gov/ada-aba/final.pdf>) establishes the following minimum number of required ADA accessible parking spaces, based on the total number of spaces in the parking area.

<sup>1</sup> Zegeer, C. V., J. R. Stewart, H. Huang and P. A. Lagerwey. Safety Effects of Marked vs. Unmarked Crosswalks at Uncontrolled Locations: Executive Summary and Recommended Guidelines. Report No. FHWA-RD-01-075, Washington DC, FHWA, March 2001.

**Exhibit 3-4 Minimum Accessible Parking Spaces**

Total Number of Parking Spaces Provided in Parking Facility	Minimum Number of Required Accessible Parking Spaces
1 to 25	1
26 to 50	2
51 to 75	3
76 to 100	4
101 to 150	5
151 to 200	6
201 to 300	7
301 to 400	8
401 to 500	9
501 to 1,000	2 percent of total
1,001 and over	20, plus 1 for each 100, or fraction thereof, over 1,000

It is also important to note, that in accordance with Section 208.2.4 of the Americans with Disabilities Act, for every six ADA accessible spaces or fraction thereof, at least one shall be a van accessible space. [Exhibit 3-5](#) shows typical layout details for parking spaces.

**Exhibit 3-5 Typical ADA Accessible Parking Space Layouts**

**TYPICAL LAYOUT OF A RESERVED PARKING SPACE**

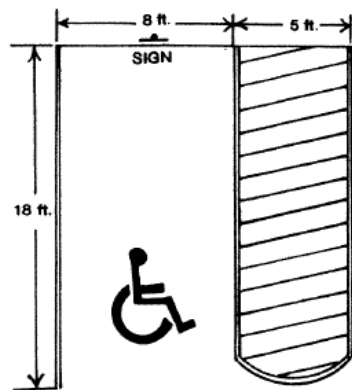

HANDICAPPED/DISABLED SYMBOL TO BE PAINTED WHITE. LINES OUTLINING THE RESERVED SPACE AND DIAGONAL LINES SHOULD BE WHITE IN COLOR.

**TYPICAL LAYOUT OF A RESERVED VAN ACCESSIBLE SPACE**

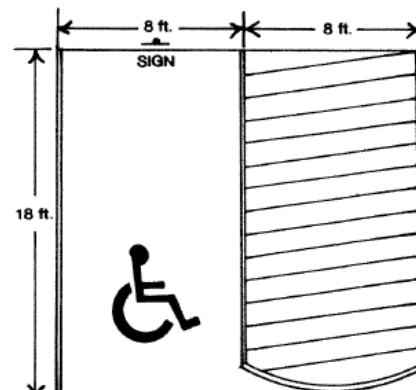

HANDICAPPED/DISABLED SYMBOL TO BE PAINTED WHITE. LINES OUTLINING THE RESERVED SPACE AND DIAGONAL LINES SHOULD BE WHITE IN COLOR.

A common practice in some commercial parking lots is to paint the entire accessible parking space blue, but painted surfaces may be very slippery when wet. Therefore, as an alternative, the symbol illustrated in Figure 3B-19 of the *MUTCD* (and included as [Exhibit 3-6](#)) may be used.

**Exhibit 3-6 Parking Space Marking with Blue Background**

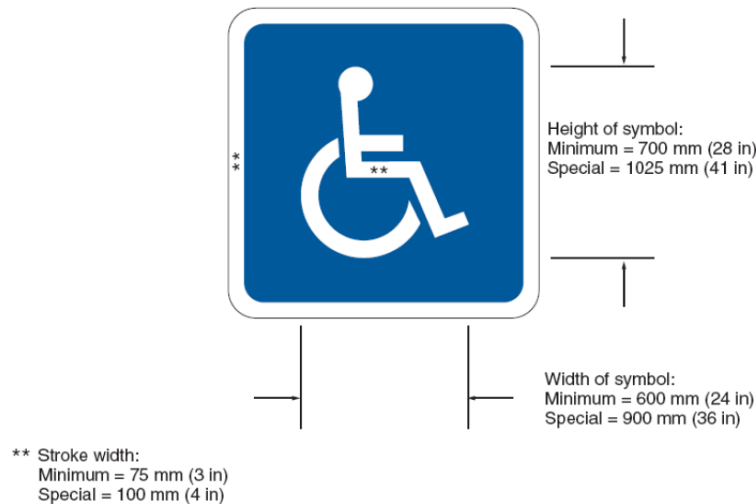

**Pavement Word and Symbol Markings**

The use of word-type pavement messages, frequently called “horizontal signing,” is an effective way to communicate with drivers providing the markings are visible. Therefore, Districts are encouraged to use horizontal signing to supplement traditional regulatory, warning, and directional signs.

Districts may supplement route marker signs with elongated route markers and directional arrows on the pavement. Preformed thermoplastic is the recommended material for words and symbol messages on bituminous surfaces, and either epoxy or tape are the recommended materials on Portland cement surfaces.

Words and symbols shall conform to Figures 3B-14 through 3B-21, and 3B-25 of the *MUTCD*. Of specific importance, Lane-Reduction Arrows shall comply with Figure 3B-14 and 3B-24.

The standard height of word messages is 8 feet on all types of roads, except “SCHOOL” is 10 feet high. A maximum of three lines of message may be used, spaced at four to ten times the legend height (i.e., typical spacing of 32 to 80 feet), and should read in the direction of travel.

**Speed Measurement Markings**

To assist the Pennsylvania State Police (PSP) in speed enforcement, Engineering Districts should cooperate with PSP in the application of transverse speed measurement markings for the State Police Aerial Reconnaissance Enforcement (SPARE) program.

PSP has offered the following general criterion that is important in the selection of SPARE locations:

- The site is on a tangent or near tangent section of highway, preferably 0.9 mile in length (minimum 0.6 mile).
- Each set of SPARE markings is totally within one judicial jurisdiction.
- The SPARE site does not cross under any structures.
- Locations exist within several miles downstream where officers can park and wait, and where they can pull offenders over.



- Posted speed limit of 55 mph or higher.
- Sites are not in Philadelphia or Delaware Counties, the eastern part of Montgomery County, or at any location in close proximity of an airport.

Procedures regarding the development of new SPARE sites are as follows:

1. The local PSP barrack submits their request to their Bureau of Patrol for consideration.
2. The Bureau of Patrol forwards recommended requests to affected Engineering District.
3. After review, the District denies the request, or approves the request and prepares a layout under the direction of a registered Pennsylvania land surveyor. If the roadway is not a tangent section, survey crews should measure the distances between the markings along the outer edge of the shoulder on the inside of the curve.
4. The District prepares a site drawing that show the markings and the Speed Check Marker (I2-1) signs, and the location of the nearest SR markers and the distance to them. (See the TC-8600 Standard Drawing, Sheet 1 of 11.)
5. The District sends the original site drawing to BOMO for processing and certification. BOMO then forwards the site drawing and an Attestation Form to the Bureau of Patrol for their final processing and files.

When the State Police request an Engineering District to remark a site, the Engineering District should provide their best estimate of when the work will be complete, and then notify the State Police when the work is physically complete.

### 3.3 Object Markers

#### Object Marker Design

Section 3C.01 and Figure 3C 1 of the *MUTCD* allow several types of Object Markers, including markers with three or more yellow retroreflectors that are a minimum of 3 inches in diameter. These circular devices are typically acrylic retroreflectors that are very bright when viewed at an angle normal to the face of the retroreflector, but they have almost no retroreflectivity when viewed at an angle of 30 degrees or more from normal.

Therefore, Districts should not use Object Markers with these circular retroreflectors because the Object Markers frequently are not visible to drivers – for example, when turning at intersections, traveling around sharp turns and curves, or at any location where the markers become misaligned. [Exhibit 3-7](#) shows the recommended Object and End-of-Roadway markers.

**Exhibit 3-7 Object and End-of-Roadway Markers****3.4 Delineators****Delineation of Guiderail, Parapets and Barriers**

Studies indicate that appropriate delineation provides substantial nighttime guidance and reduces the likelihood of nighttime crashes. Therefore, it is the Department's policy to upgrade delineation to improve guidance for motorists, particularly older drivers.

As a part of this effort, Engineering Districts shall:

1. Incorporate guiderail, parapet and barrier delineation into all PS&E packages.
2. Establish a program to retrofit and maintain delineation on the National Highway System (NHS) when:
  - The average daily traffic volume (ADT) is 3,000 or greater.
  - Shoulders are 6 feet or less in width.
  - There is evidence of vehicles running off the roadway and hitting fixed objects.

The spacing of these devices on new installations should be as follows:

1. At 75 feet on tangent roadway sections and on horizontal curves with less than 2 degrees of curvature.
2. At 37.5 feet on all 2-degree and sharper horizontal curves and on approaches to structures where the full width shoulder transitions to a narrower width across the structure. In these cases, parapet-mounted delineation should also be at the 37.5-foot spacing.

**Guiderail Delineation**

For W-beam guiderail, use the Type D guiderail delineator (i.e., polycarbonate, butterfly-shaped models that fit in the web of the guiderail) as shown on Sheet 2 of 4 of TC-8604. For highway maintenance crews, these delineators are currently available on statewide contract Legacy No. 9905-09 using the following SAP material numbers:

<u>SAP Material No.</u>	<u>Description</u>
304918	Guiderail web-mounted, Type D (W/B)
144433	Guiderail web-mounted, Type D (W/R)
144431	Guiderail web-mounted, Type D (W/W)
144432	Guiderail web-mounted, Type D (Y/B)
144430	Guiderail web-mounted, Type D (Y/R)

Other types of delineators such as post-mounted guiderail delineation (e.g., “RailRider”) or independently mounted flexible delineator posts are encouraged along strong-post cable guiderail systems and as a continuation of the delineation beyond the limits of the guiderail to provide information regarding continued important alignment features (sharp horizontal curve where the guiderail ends or starts midway in curve).

#### Delineation of Parapets and Barriers

Install barrier-mounted delineator on all types of median barrier and single-face barrier using the spacing indicated above. Install both side-mount and top-mount delineation as illustrated on Sheet 2 of 4 of TC-8604 for the traffic side of each barrier.

### 3.5 Islands and Median Barriers

#### **Mountable Curbs and Resurfacing**

Some older arterials have mountable curb medians separating traffic. Although these mountable curbs have a minimal effect on averting head-on collisions resulting from out-of-control vehicles, they do have a significant safety benefit in restricting turning movements either from the mainline or from adjacent driveways. As these arterials age and require overlays, the overlays compromise safety by allowing drivers to begin making left turns.

Therefore, the District should assess the project needs prior to resurfacing. Specifically, the District needs to answer the following question for all resurfacing projects involving mountable curbs: *“Will the removal of the mountable curb result in a substantive increase in left-turn movements?”*

1. If the answer is “no” and there is minimal or no potential for developing turning movements in the future, the project may eliminate the mountable curb. However, the District should review the potential for placing a positive standard median barrier to prevent head-on crashes. If this is not possible or appropriate, the District may replace the mountable curb with standard pavement markings.
2. If the answer is “yes,” the first priority is to consider replacing the mountable curb with a positive standard median barrier to prevent head-on crashes and restrict left turn movements. This is particularly important if the operating speeds are in excess of 40 mph. Give special attention to addressing sight distance concerns at existing breaks in the median. If the District cannot adequately address these sight distance concerns, replace the mountable curb in kind, per the Roadway Construction Standards (RC-65M).
3. The District should document the above study assessment in the project file.

### 3.6 Chapter 3 Appendix

**PAVEMENT MARKINGS - CONSTRUCTION INSPECTOR QUALITY ASSURANCE REVIEW FORM**

DISTRICT \_\_\_\_\_ COUNTY \_\_\_\_\_ PROJECT \_\_\_\_\_

TRAFFIC ROUTE \_\_\_\_\_ STATE ROUTE \_\_\_\_\_ SEGMENT \_\_\_\_\_ OFFSET \_\_\_\_\_

APPLICATION CONTRACTOR \_\_\_\_\_ PRIME \_\_\_\_\_ SUB \_\_\_\_\_

DATE: \_\_\_\_\_ TIME: \_\_\_\_\_ WEATHER: \_\_\_\_\_

PAVEMENT TEMPERATURE \_\_\_\_\_ AMBIENT TEMPERATURE \_\_\_\_\_ % RELATIVE HUMIDITY \_\_\_\_\_

TYPE OF MARKING: Long Lines \_\_\_\_\_ Arrow \_\_\_\_\_ Legend \_\_\_\_\_

Other \_\_\_\_\_

MATERIAL: Paint \_\_\_\_\_, Epoxy \_\_\_\_\_, Thermoplastic: Hot \_\_\_\_\_ or Preformed \_\_\_\_\_

Cold Plastic: Inlaid \_\_\_\_\_ or Surface Applied \_\_\_\_\_,

Other \_\_\_\_\_

MANUFACTURER: \_\_\_\_\_ MANUFACTURED

DATE: \_\_\_\_\_

PRODUCT NAME or FORMULA: \_\_\_\_\_ MATERIAL CERTIFICATION PROVIDED? Y / N \_\_\_\_\_

COMPLETE THE FOLLOWING APPROPRIATE SECTIONS:

**A. TRUCK MOUNTED AND SELF-PROPELLED MACHINE OPERATION (LONG LINES)**

1. Is the marking being applied in accordance with the manufacturer's specifications? Yes \_\_\_\_\_ No \_\_\_\_\_
2. Is the roadway surface clean and dry? Yes \_\_\_\_\_ No \_\_\_\_\_
3. Is a primer being used prior to the application? Yes \_\_\_\_\_ No \_\_\_\_\_ N/A \_\_\_\_\_
4. Are the pavement, ambient temperature and percentage of relative humidity being monitored and documented at least three times a day? Yes \_\_\_\_\_ No \_\_\_\_\_
5. Was paint mixed before using? Yes \_\_\_\_\_ No \_\_\_\_\_
6. Are center line guns adjusted to provide a 6-inch space between lines? (+ 1/2 inch) Yes \_\_\_\_\_ No \_\_\_\_\_ N/A \_\_\_\_\_
7. Are lane lines 4 inches to the right of the pavement joint or seam? (+ 1/2 inch) Yes \_\_\_\_\_ No \_\_\_\_\_ N/A \_\_\_\_\_
8. Are edge lines 4 inches from the edge of the pavement? (+ 1/2 inch) Yes \_\_\_\_\_ No \_\_\_\_\_ N/A \_\_\_\_\_
9. What is the application speed? \_\_\_\_\_ MPH

PAINT/BINDER AND BEAD GUNS									
	Left Outside			Left Inside			Right		
	Yes	No	N/A	Yes	No	N/A	Yes	No	N/A
10. Are the edges of the lines clean and sharp?									
11. Are the lines being applied uniformly?									
12. Are glass beads evenly distributed over entire line?									
13. Are glass beads properly embedded (60-70%)?									
14. What is the width, in inches, of the traffic lines being applied?									
15. What is the length of the skip line pattern (Cycle should be 40')?									
16. What is the length of the skip line (10')?									
17. What is the binder temperature at the guns?									
18. What is the measured application rate of glass beads?			# / Gal.			# / Gal.			# / Gal.
19. What is the quantity of binder used and length of lines applied? (Quantity of paint should be in compliance with the following charts.)			Gal. Ft.			Gal. Ft.			Gal. Ft.

4" WIDE LINES (15 MILS)

100 ft. 0.312 gals.  
 500 ft. 1.559 gals.  
 1000 ft. 3.117 gals.  
 2500 ft. 7.794 gals.  
 5280 ft. 16.460 gals.

4" WIDE LINES (12 MILS)

100 ft. 0.249 gals.  
 500 ft. 1.247 gals.  
 1000 ft. 2.494 gals.  
 2500 ft. 6.236 gals.  
 5250 ft. 13.170 gals.

NOTES

- 1) Skip line uses 75% less paint than a solid line.
- 2) Six inch wide lines use 50% more paint than 4 inch wide lines.
- 3) Eight inch wide lines use 100% more paint than 4 inch wide lines.

To determine gallons for a 4 inch line 15 mils thick, divide feet of line by 320.7776

To determine gallons for a 4 inch line 12 mils thick, divide feet of line by 400.9112

To determine gallons of paint for legends and symbols at 15 mil thickness, divide square feet of markings by 106.93

**B.MANUAL OR WALK BEHIND OPERATION (ARROWS, LEGENDS, ETC.)**

- 1. Type of application: Hand Gun\_\_\_\_\_ Machine \_\_\_\_\_
- 2. Is the marking properly centered in the lane? Yes\_\_\_\_\_ No\_\_\_\_\_
- 3. Are the edges clean and sharp? Yes\_\_\_\_\_ No\_\_\_\_\_
- 4. Does the marking have uniform paint coverage? Yes\_\_\_\_\_ No\_\_\_\_\_
 

(Paint should be sufficiently heavy to allow for 60-70% glass bead embedment.)
- 5. Type of glass bead applications: Hand\_\_\_\_\_ Gravity Fed \_\_\_\_\_ Pressure Fed \_\_\_\_\_ N/A\_\_\_\_\_
- 6. Are glass beads evenly distributed over the marking? Yes\_\_\_\_\_ No\_\_\_\_\_
- 7. Are glass beads properly embedded (60-70%)? Yes\_\_\_\_\_ No\_\_\_\_\_

**C.RETROREFLECTIVITY MEASUREMENTS OF APPLIED PAVEMENT MARKINGS**

- 1. Did contractor follow PTM 431? Yes\_\_\_\_\_ No\_\_\_\_\_
- 2. Did markings meet retroreflectivity requirements? Yes\_\_\_\_\_ No\_\_\_\_\_

Remarks:

---

---

---

---

---

---

---

---

---

---

---

---

---

---

---

---

---

---

---

---

---

---

---

---

---

---



---

Inspector

FID# \_\_\_\_\_

## CHAPTER 4 - TRAFFIC SIGNALS

### 4.1 General

#### Purpose

This chapter provides the Department's policies, procedures and further direction relative to the study, design, installation, operation, and maintenance of all types of traffic signals.

This chapter emphasizes the need for local authorities to understand the costs associated with owning a traffic signal. Therefore, prior to the Department undertaking any study to determine if a signal may be warranted, the Department must receive a written financial commitment from the municipal governing body as indicated in [Application and Financial Commitment](#) on page [4-11](#).

#### Types of Traffic Signals

In the 67 Pa. Code § 212.2, the Commonwealth of Pennsylvania has adopted the Manual of Uniform Traffic Control Devices (MUTCD) unless otherwise specified in the regulation, as published by the Federal Highway Administration (FHWA). The following types and uses of highway traffic signals are discussed in Part 4 of the MUTCD 2009 Edition and herein:

- Traffic Control Signals (MUTCD 2009, Chapter 4D)
- Pedestrian Signals (MUTCD 2009, Chapter 4E)
- Pedestrian Hybrid Beacons (Not permitted in Pennsylvania)
- Traffic Control Signals and Hybrid Beacons for Emergency-Vehicle Access (MUTCD 2009, Chapter 4G)- (Hybrid Beacons for Emergency-Vehicle Access are not permitted in Pennsylvania)
- Traffic Control Signals for One-lane, Two-way facilities (Chapter 4H)
- Traffic Control Signals for Freeway Entrance Ramps (Chapter 4I)
- Traffic Control for Movable Bridges (Not permitted in Pennsylvania)
- Highway Traffic Signals at Toll Plazas (Chapter 4K) (Please contact the Pennsylvania Turnpike Commission regarding the placement of Highway Traffic Signals at Toll Plazas)
- Flashing Beacons (Chapter 4L)
- Lane-use Control Signals (Chapter 4M)
- In-Roadway Lights (Chapter 4N)

#### Responsibility to Approve, Install, and Maintain Traffic Signals

In accordance with 67 Pa. Code §212.5, it is the Department's responsibility to approve all traffic signals except:

- When municipal or private funding is used within the City of Philadelphia and City of Pittsburgh (first and second class cities). This is applicable unless there is an agreement between the city and the Department.
- When municipal or private funding is being used within a municipality that has obtained traffic engineering certification in accordance with 67 Pa. Code §205. A listing of all of the Approved 67 Pa. Code Chapter 205 municipalities are contained within [Section 4.15](#) on [page 4-90](#).



Moreover, in accordance with 67 Pa. Code 212.5 (relating to installation and maintenance responsibilities), local authorities or other agencies are responsible for requesting, installing, maintaining, and operating all traffic signals on both State and local highways, including all associated items (signs, pavement markings, emergency preemption devices, advanced signing, electrically powered signs, etc...) included on Department-approved traffic signal permit plans.

**Exhibit 4-1** shows a further breakdown of the responsibilities.

### **Laws, Regulations, and Other Publications**

In Pennsylvania, the Vehicle Code (75 Pa.C.S. § 101) establishes laws for drivers and vehicles, and mandates that the Department and local authorities adhere to the regulations of the Department. Department regulations are contained in 67 Pa. Code (<http://www.pacode.com/secure/data/067/067toc.html>), and the primary regulation that addresses issues relative to traffic control devices is Chapter 212 "Official Traffic-Control Devices".

**Exhibit 4-2** and **Exhibit 4-3** identifies the applicable laws, regulations, and publications that may be helpful in the design, construction, maintenance and operation of traffic signals.

**Exhibit 4-1 Responsibilities of Local Authorities and the Department**

Task	Local Authorities	PennDOT
<b>Preliminary Assessment</b>		
Process review	X	1
Site investigation	X	1
Data collection	X	1
Study development	X	1
Municipal concurrence	X	
<b>Application Submission</b>		
TE-952 form, certifying that the local officials have approved a municipal resolution committing resources to install and maintain signals if approved	X	
Study by P.E., complete with intersection plan view and warrant analysis	X	1
Maintenance agreement	X	
<b>Department Application Review</b>		
Approve, deny or request additional information		X
Authorize plan development		X
Explain required detail based on type of project, e.g., if modifying an existing permit simplify the level of detail		X
<b>Design and Review</b>		
Develop permit plan sheets with all signal heads, supports, detectors, controller, phasing diagram, signs, pavement markings, etc.	X	1
Develop construction plans and specifications	X	1
Authorization to construct	X	X
<b>Construction</b>		
Inspection	X	1
As-built drawings	X	1
<b>Operational Validation</b>		
30-day testing	X	1
Department acceptance		X
<b>Maintenance</b>		
Budgeting	X	
Response and preventative maintenance	X	
Operational maintenance	X	
Design modifications	X	

1. The Department would generally perform this function for Department construction projects on State highways, but local authorities may be responsible for a share of the costs

**Exhibit 4-2 Applicable Laws, Regulations, and Publications**

Short Description	Title and Description
<b>Federal and State Laws:</b>	
USC 23 CFR, 655	United States Code (USC) 23 CFR, Part 655 ( <a href="http://www.fhwa.dot.gov/legregs/directives/fapg/cfr0655f.htm">http://www.fhwa.dot.gov/legregs/directives/fapg/cfr0655f.htm</a> )
Vehicle Code	Vehicle Code, 75 Pa.C.S. § 101( <a href="http://www.dot4.state.pa.us/vehicle_code/index.shtml">http://www.dot4.state.pa.us/vehicle_code/index.shtml</a> )
<b>Federal and State Regulations:</b>	
MUTCD	Manual on Uniform Traffic Control Devices, MUTCD, latest edition, Federal Highway Administration. ( <a href="http://mutcd.fhwa.dot.gov/">http://mutcd.fhwa.dot.gov/</a> )
67 Pa. Code Chapter 212	Official Traffic Control Devices . Pennsylvania's supplement to the MUTCD as specified within 75 Pa. C.S. § 6103. ( <a href="http://www.pacode.com/secure/data/067/067toc.html">http://www.pacode.com/secure/data/067/067toc.html</a> )
67 Pa. Code Chapter 205	Municipal Traffic Engineering Certification. ( <a href="http://www.pacode.com/secure/data/067/chapter205/chap205toc.html">http://www.pacode.com/secure/data/067/chapter205/chap205toc.html</a> )
<b>Design Publications:</b>	
Pub. 10	<u>Design Manual Part 1, Transportation Project Development Process.</u> Explains the Department’s project development process.
Pub. 13M	<u>Design Manual Part 2, Highway Design,</u> Provides current procedures and guidelines to design highways – specifically, Chap. 3 is on intersections and Chap. 6 on pedestrians.
Pub. 14M	<u>Design Manual Part 3, Plans Presentation,</u> Provides the general format and detail for the development of plan sheets – specifically, Chap. 4 addresses traffic control in work zones and <u>Chap. 10</u> addresses traffic signal plans.
Pub. 149	<u>Traffic Signal Design Handbook.</u> A guide for the design and operation of a traffic signal installation.
Pub. 236	<u>Handbook of Approved Signs.</u> This book identifies all official signs for use in Pennsylvania and provides sign size, application detail, and design layouts for each sign.
<b>Construction Publications:</b>	
Pub. 8	<u>Construction Manual.</u> Supplements Pub. 408 by providing some helpful information for inspectors, containing information generally not found in other manuals. It uses the same section numbering as Pub. 408.
Pub. 35 (Bulletin 15)	<u>Approved Construction Materials</u> (also known as Bulletin 15). Identifies approved construction materials or manufacturers of approved materials.
Pub. 72M	<u>Standards for Roadway Construction</u> (i.e., RC Standards). Graphically illustrates design details and includes notes – the RC-70 series addresses curbs and sidewalks.
Pub. 111	<u>Traffic Control -- Pavement Markings and Signing Standards</u> (i.e., TC Standards). Graphically illustrates the design and construction of signs and markings.
Pub. 148	<u>Traffic Standards -- Signals, TC-8800 Series.</u> Graphically illustrates the design and construction details for mast arms, strain poles, pedestals, junction boxes, signal heads, detectors, etc.
Pub. 213	<u>Temporary Traffic Control Guidelines.</u>
Pub. 408	<u>Highway Specifications.</u> Detailed specifications for most highway construction projects. Section 900 is titled “Traffic Accommodation and Control.”
Pub. 647M	<u>Civil and Structural Standards for Intelligent Transportation Systems, ITS-1000M Series.</u> Graphically illustrates the design and construction details for supports (poles and other structures), CCTV mountings, cabinet, trenches, fiber optics, etc., for ITS.
<b>Traffic Signal Maintenance Publication:</b>	
Pub. 191	<u>Guidelines for the Maintenance and Operation of Traffic Signals.</u> A guide for local authorities detailing the items needing maintenance, and budgeting and contracting details.

**Exhibit 4-3 Other Department and Public Agency Documents**

<b>Other Department Publications:</b>
All of these publications are available both electronically and as hard copies at: <a href="ftp://ftp.dot.state.pa.us/public/PubsForms/Publications/PUB%2012.pdf">ftp://ftp.dot.state.pa.us/public/PubsForms/Publications/PUB%2012.pdf</a> .
<b>Other Public Guidance Documents:</b>
Highway Capacity Manual (2010 Edition). ( <a href="http://www.hcm2010.org/">http://www.hcm2010.org/</a> )
<u><a href="#">Transportation Advisory Committee (TAC) 2010 Transportation Funding Study</a></u>
<u><a href="#">Transportation Advisory Committee (TAC) Congestion Mitigation and Smart Transportation Study</a></u>
<u><a href="#">Transportation Advisory Committee (TAC) Traffic Signal Review Study</a></u>
<u><a href="#">FHWA Traffic Signal Retiming Manual</a></u>
<u><a href="#">FHWA Traffic Signal Operations Website</a></u>
<u><a href="#">NCHRP Synthesis 403 "Adaptive Traffic Control Systems: Domestic and Foreign State of Practice"</a></u>
<u><a href="#">Institute of Transportation Engineers Trip General Manual</a></u>
<u><a href="#">FHWA Traffic Control Systems Handbook</a></u>
<u><a href="#">FHWA Traffic Analysis Toolbox</a></u>

**Meaning and Application of the Traffic Signal Indications Vehicular Signal Indications**

**Steady Red Indication**

Meaning

- a) **Vehicular Traffic:** Vehicular traffic facing a steady circular red shall stop at a clearly marked stop line, or if none, before entering the crosswalk on the near side of the intersection, or if none, then before entering the intersection and shall remain standing until an indication to proceed is displayed, except as provided in the next paragraph.



Unless a sign is in place prohibiting a turn, vehicular traffic facing a steady circular red may enter the intersection to turn right, or to turn left from a one-way roadway onto a one-way roadway, after stopping as required above. Such vehicular traffic shall yield the right-of-way to pedestrians lawfully within an adjacent crosswalk and to other traffic lawfully using the intersection.

- b) **Pedestrian Traffic:** Unless otherwise directed by a pedestrian signal, pedestrians facing a steady circular red shall not enter the roadway.

Application

- a) **Vehicular Traffic:** A steady circular red shall be given when it is intended to prohibit traffic from entering the intersection or other controlled area.

A steady circular red may be displayed with the appropriate green arrow indications when it is intended to permit vehicular traffic to make a specified turn or turns, and to prohibit traffic from proceeding straight ahead through the controlled area.

- b) **Pedestrian Traffic:** A steady circular red shall be given when it is intended to prohibit all traffic, except pedestrians directed by a pedestrian signal, from entering the roadway.

**Steady Yellow Indication**

**Meaning**

- a) **Vehicular Traffic:** Vehicular traffic facing a steady circular yellow is thereby warned that the related green movement is being terminated or that a red indication will be displayed immediately thereafter.
- b) **Pedestrian Traffic:** Pedestrians facing a steady circular yellow, unless otherwise directed by a pedestrian signal, are thereby advised that there is insufficient time to cross



**Application**

A steady circular yellow shall be given following a circular green indication in the same signal face.

**Steady Green Indication**

**Meaning**

- a) **Vehicular Traffic:** Vehicular traffic facing a circular green may proceed straight through or turn right or left unless a sign indicates otherwise. But vehicular traffic, including vehicles turning right or left, shall yield the right-of-way to other vehicles, and to pedestrians lawfully within the intersection or an adjacent crosswalk, at the time such signal is exhibited.
- b) **Pedestrian Traffic:** Unless otherwise directed by an official sign or by a pedestrian signal, pedestrians facing a circular green may proceed with caution across the roadway within any marked or unmarked crosswalk.



**Application**

A steady circular green shall be given only when it is intended to permit traffic to proceed in any direction which is lawful and practical.

**Steady Red Arrow Indication**

**Meaning**

- a) **Vehicular Traffic:** Vehicular traffic facing a steady red arrow signal indication shall not enter the intersection to make the movement indicated by the arrow and, unless entering the intersection to make another movement permitted by another signal indication, shall stop at a clearly marked stop line; but if there is no stop line, before entering the crosswalk on the near side of the intersection, or if there is no crosswalk, then before entering the intersection, and shall remain stopped until a signal indication permitting the movement indicated by such red arrow is shown.



When a permitted right turn on a RED ARROW signal indication, vehicular traffic facing a RED ARROW signal indication is permitted to enter the intersection to turn right, or to turn left from a one-way street into a one-way street, after stopping. Such vehicular traffic shall yield the right-of-way to pedestrians lawfully within an adjacent crosswalk and to other traffic lawfully using the intersection.

**Application**

A steady RED ARROW signal indication shall be displayed when it is intended to prohibit traffic, except pedestrians directed by a pedestrian signal head, from entering the intersection or other controlled area to make the indicated turn. Prohibited right and left turn traffic signal indications are typically supported by a R10-10L (Left Turn Signal) or R10-10R (Right Turn Signal) sign(s).

**Steady Yellow Arrow Indication**

**Meaning**

A steady YELLOW ARROW signal indication:

- a) **Vehicular Traffic:** Vehicular traffic facing a steady YELLOW ARROW signal indication is thereby warned that the related GREEN ARROW movement or the related flashing arrow movement is being terminated. The rules set forth concerning vehicular operation under the movement(s) being terminated shall continue to apply while the steady YELLOW ARROW signal indication is displayed.
- b) **Pedestrian Traffic:** Pedestrians facing a steady YELLOW ARROW signal indication, unless otherwise directed by a pedestrian signal indication or other traffic control device shall not start to cross the roadway.



**Application**

A Steady Yellow Arrow indication:

- 1) Shall be displayed in the same direction as a GREEN ARROW signal indication following a GREEN ARROW signal indication in the same signal face, unless: (a) The GREEN ARROW signal indication and a CIRCULAR GREEN (or straight-through GREEN ARROW) signal indication terminate simultaneously in the same signal face, or (b) The green arrow is a straight-through GREEN ARROW (see Item B.1, MUTCD 4D.05).
- 2) Shall be displayed in the same direction as a flashing YELLOW ARROW signal indication or flashing RED ARROW signal indication following a flashing YELLOW ARROW signal indication or flashing RED ARROW signal indication in the same signal face, when the flashing arrow indication is displayed as part of a steady mode operation, if the signal face will subsequently display a steady red signal indication.
- 3) Shall not be displayed in conjunction with the change from a steady RED ARROW, flashing RED ARROW, or flashing YELLOW ARROW signal indication to a GREEN ARROW signal indication, except when entering preemption operation as provided in Item 5(a).
- 4) Shall not be displayed when any conflicting vehicular movement has a green or yellow signal indication (except for the situation regarding U-turns to the left provided in Paragraph 4) or any conflicting pedestrian movement has a WALKING PERSON (symbolizing WALK) or flashing UPRAISED HAND (symbolizing DONT WALK) signal indication, except that a steady left-turn (or U-turn to the left) YELLOW ARROW signal indication used to terminate a flashing left-turn (or U-turn to the left) YELLOW ARROW or a flashing left-turn (or U-turn to the left) RED ARROW signal indication in a signal face controlling a permissive left-turn (or U-turn to the left) movement as described in Sections 4D.18 and 4D.20 shall be permitted to be displayed when a CIRCULAR YELLOW signal indication is displayed for the opposing through movement. Vehicles departing in the same direction shall not be considered in conflict if, for each turn lane with moving traffic, there

is a separate departing lane, and pavement markings or raised channelization clearly indicate which departure lane to use.

- 5) Shall not be displayed to terminate a flashing arrow signal indication on an approach from which drivers are turning left permissively or making a U-turn to the left permissively unless one of the following conditions exists:
  - a) A steady CIRCULAR YELLOW signal indication is also simultaneously being displayed to the opposing approach;
  - b) An engineering study has determined that, because of unique intersection conditions, the condition described in Item (a) cannot reasonably be implemented without causing significant operational or safety problems and that the volume of impacted left-turning or U-turning traffic is relatively low, and those left-turning or U-turning drivers are advised that a steady CIRCULAR YELLOW signal indication is not simultaneously being displayed to the opposing traffic if this operation occurs continuously by the installation near the left-most signal head of a W25-1 sign (see MUTCD Section 2C.48) with the legend ONCOMING TRAFFIC HAS EXTENDED GREEN; or
  - c) Drivers are advised of the operation if it occurs only occasionally, such as during a preemption sequence, by the installation near the left-most signal head of a W25-2 sign (see MUTCD Section 2C.48) with the legend ONCOMING TRAFFIC MAY HAVE EXTENDED GREEN.

**Steady Green Arrow Indication**

**Meaning**

- a) **Vehicular Traffic:** Vehicular traffic facing a GREEN ARROW signal indication displayed alone or in combination with another signal indication is permitted to cautiously enter the intersection only to make the movement indicated by such arrow, or such other movement as is permitted by other signal indications displayed at the same time.



Such vehicular traffic, including vehicles turning right or left or making a U-turn movement, shall yield the right-of-way to:

- 1) Pedestrians lawfully within an associated crosswalk, and
  - 2) Other vehicles lawfully within the intersection.
- b) **Pedestrian Traffic:** Pedestrians facing a GREEN ARROW signal indication, unless otherwise directed by a pedestrian signal indication or other traffic control device, shall not cross the roadway.

**Application**

A steady GREEN ARROW signal indication:

- 1) Shall be displayed only to allow vehicular movements, in the direction indicated, that are not in conflict with other vehicles moving on a green or yellow signal indication and are not in conflict with pedestrians crossing in compliance with a WALKING PERSON (symbolizing WALK) or flashing UPRAISED HAND (symbolizing DONT WALK) signal indication. Vehicles departing in the same direction shall not be considered in conflict if, for each turn lane with moving traffic, there is a separate departing lane, and pavement markings or raised channelization clearly indicate which departure lane to use.
- 2) Shall be displayed on a signal face that controls a left-turn movement when said movement is not in conflict with other vehicles moving on a green or yellow signal indication (except for the situation

regarding U-turns ) and is not in conflict with pedestrians crossing in compliance with a WALKING PERSON (symbolizing WALK) or flashing UPRAISED HAND (symbolizing DONT WALK) signal indication. Vehicles departing in the same direction shall not be considered in conflict if, for each turn lane with moving traffic, there is a separate departing lane, and pavement markings or raised channelization clearly indicate which departure lane to use.

**Flashing Red Arrow Indication**

The use of the flashing red arrow is not allowed in Pennsylvania until otherwise indicated in the Vehicle Code § 3111 and 3112.

**Flashing Yellow Arrow Indication**

The use of the flashing yellow arrow is not allowed in Pennsylvania until otherwise indicated in the Vehicle Code § 3111 and 3112.

**Pedestrian Indications**

Some typical Pedestrian Indications are illustrated in [Exhibit 4-4](#).

**Exhibit 4-4 Typical Pedestrian Indications**

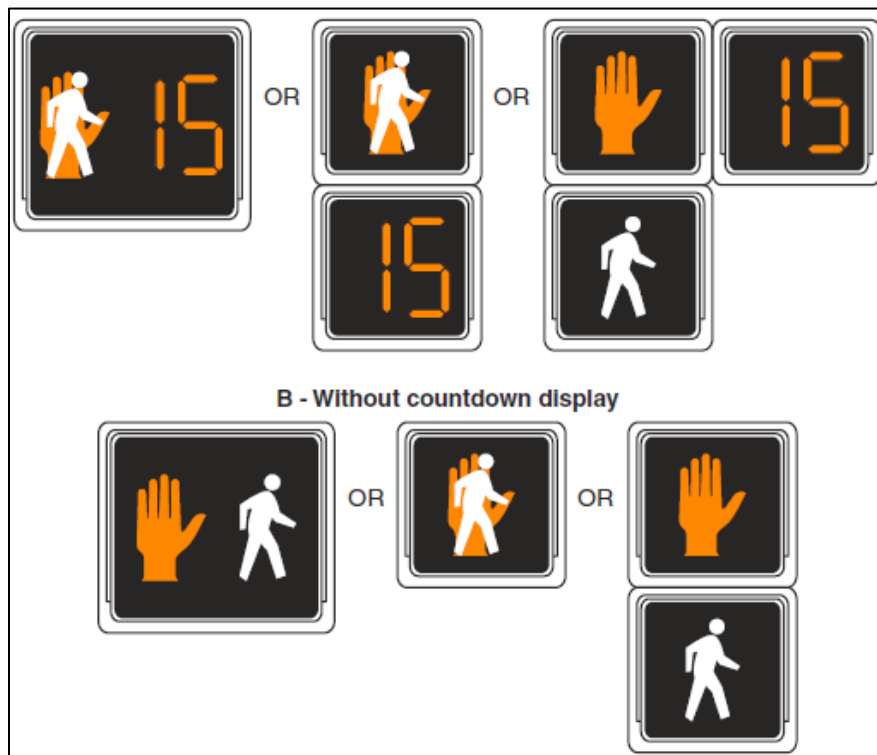

**Walk Indication**

**Meaning**

A steady WALKING PERSON (symbolizing WALK) signal indication means that a pedestrian facing the signal indication is permitted to start to cross the roadway in the direction of the signal indication, possibly in conflict with turning vehicles. The pedestrian shall yield the right-of-way to vehicles lawfully within the intersection at the time that the WALKING PERSON (symbolizing WALK) signal indication is first shown.



**Flashing Don't Walk Indication****Meaning**

A flashing UPRAISED HAND (symbolizing DONT WALK) signal indication means that a pedestrian shall not start to cross the roadway in the direction of the signal indication, but that any pedestrian who has already started to cross on a steady WALKING PERSON (symbolizing WALK) signal indication shall proceed to the far side of the traveled way of the street or highway, unless otherwise directed by a traffic control device to proceed only to the median of a divided highway or only to some other island or pedestrian refuge area.

**Don't Walk Indication****Meaning**

A steady UPRAISED HAND (symbolizing DONT WALK) signal indication means that a pedestrian shall not enter the roadway in the direction of the signal indication.

**Countdown Indication****Meaning**

The countdown indication which flashes UPRAISED HAND (symbolizing DONT WALK) signal indication provides crossing time information to a pedestrian so they will not start to cross the roadway in the direction of the signal indication and it also provides key interval information to a pedestrian who has already started to cross on a steady WALKING PERSON (symbolizing WALK) signal indication to proceed to the far side of the traveled way of the street or highway, unless otherwise directed by a traffic control device to proceed only to the median of a divided highway or only to some other island or pedestrian refuge area.

**Alternatives to Traffic Signals**

Since vehicular delay and the frequency of some types of crashes are sometimes greater under traffic signal control than under STOP sign control, consideration should be given to providing alternatives to traffic control signals even if one or more of the signal warrants has been satisfied.

These alternatives may include, but are not limited to, the following:

- a) Installing signs along the major street to warn road users approaching the intersection;
- b) Relocating the stop line(s) and making other changes to improve the sight distance at the intersection;
- c) Installing measures designed to reduce speeds on the approaches;
- d) Installing a flashing beacon at the intersection to supplement STOP sign control;
- e) Installing flashing beacons on warning signs in advance of a STOP sign controlled intersection on major and/ or minor-street approaches;
- f) Adding one or more lanes on a minor-street approach to reduce the number of vehicles per lane on the approach;
- g) Revising the geometrics at the intersection to channelize vehicular movements and reduce the time required for a vehicle to complete a movement, which could also assist pedestrians;
- h) Revising the geometrics at the intersection to add pedestrian median refuge islands and/or curb extensions;

- i) Installing roadway lighting if a disproportionate number of crashes occur at night;
- j) Restricting one or more turning movements, perhaps on a time-of-day basis, if alternate routes are available;
- k) If the warrant is satisfied, installing multi-way STOP sign control;
- l) In-Roadway Warning Lights (see Chapter 4N) if pedestrian safety is the major concern;
- m) Installing a roundabout; and
- n) Employing other alternatives, depending on conditions at the intersection.

### **PennDOT's Traffic Signal Portal**

The Department's Traffic Signal Portal can be found by visiting:

<http://www.dot.state.pa.us/Portal%20Information/Traffic%20Signal%20Portal/index.htm>

The portal includes, but is not limited the following sources:

- a) Publications, policies, forms and other
- b) Approved Products Listing
- c) Frequently Asked Questions
- d) Traffic Signal Processes and Procedures
- e) Automated Red Light Enforcement
- f) Mapping and Spreadsheets
- g) Training Updates
- h) Traffic Signal Performance Measures
- i) Recent News

## **4.2 Requests for Traffic Signals**

### **Application and Financial Commitment**

Requests for approval to install traffic signals at a location should be submitted to the District Executive who is responsible for that particular District. Each official request must include a completed application form executed by the appropriate officials and a scale drawing indicating the geometric and topographic features of the location and the most recent crash data. All requests from local authorities must also include a written financial commitment from the municipal governing body indicating that:

- They will commit the appropriate funds to construct the signal installation within 2 years of permit issuance should the Department concur with the Traffic Signal Warrant analysis; and
- The municipality will agree to operate and maintain the signal on an ongoing basis after the signal is installed.

### **Procedure**

Requests for a new traffic signal or an update to an existing one are submitted to the Department in variety of ways. When a request comes from the general public, or from someone other than the local authorities,

the Department should acknowledge receipt of the request and advise the individual or party to refer their request to the proper local authorities since the local authorities would be responsible for all costs associated with any installation of the device, and for all future operation and maintenance costs.

When the Engineering District is aware that local authorities are interested in installing a traffic signal, it is desirable to have a face-to-face meeting with the officials because most local officials have limited knowledge of the costs involved with owning and operating a traffic signal because:

- Approximately 50 percent of municipalities currently do not have any traffic signals and about 25 percent of the municipalities that do have traffic signals only have one traffic signal.
- Local officials are frequently changing. Therefore, many local officials have limited knowledge of the procedures for installing traffic signals, and the costs involved with installing and operating traffic signals.

Therefore, except for those municipalities with more experience, Engineering Districts should meet with the local officials prior to the local authorities undertaking a study to determine if a signal may be warranted.

If the local authorities make a written request, the District should write an appropriate response. The response letter should normally suggest a meeting between the local officials and the District Traffic Unit at the earliest possible opportunity to discuss the Department's policies and procedures as they relate to traffic signals and to determine the extent of the problem as seen by the local officials. If a traffic signal is determined to be the appropriate traffic control device by the District Traffic Engineer, the District Traffic unit is responsible for monitoring the traffic signal approval process (including but not limited to the application, traffic signal maintenance agreement (if applicable), and traffic signal permit) to ensure that a traffic signal is installed within the 2-year municipal commitment date.

If the Engineering District either receives a phone call or hears of a proposed traffic signal by other means, it would be appropriate to make a phone call to the municipality, to discuss and to suggest a meeting.

A meeting would:

1. Allow the local officials to explain their concerns about the location, and give the Engineering District an opportunity to perhaps suggest other alternatives.
2. Give the Engineering District an opportunity to explain Department policies and procedures, signal warrants, current technologies to consider and to note relative Department publications. The meeting will also assist in determining the best time to perform a traffic engineering investigation; for instance, the need to conduct an investigation during the school year where school activities are a primary concern.
3. Allow the Engineering District an opportunity to provide an estimated range of costs to design, construct, operate, and maintain the traffic signal.
4. Advise the local officials that they will need to pass a resolution and provide a written financial commitment before the Department will even

**Things to Prepare Prior to the Meeting**

1. Handouts enumerating alternatives to traffic signals from Section 4B.04 of the MUTCD.
2. Typical costs both to install and to maintain traffic signals.
3. A copy of criteria for each of the nine MUTCD warrants, plus the PA-1 and PA-2 Warrants.
4. A list of technologies that local officials should consider (i.e., EVP).
5. Copies of applicable forms and agreements, and a list of applicable Department publications.
6. Consider providing a copy of the TE-952 form and the Traffic Signal Maintenance Agreement.

review their application since it could be a problem if after a signal was studied and found to be warranted, the local authorities were not willing to follow through with construction. This local authorities financial commitment must indicate that:

- They will commit the appropriate funds to construct the signal installation within 2 years of permit issuance should the Department find that the installation meets warrants; and
- They agree to operate and maintain the signal on an ongoing basis after the signal is installed in accordance with [§ 212.5](#) of Title 67 of the Pennsylvania Code (67 Pa. Code §212.5).

If a developer is proposing a traffic signal, the Engineering District should advise them work through the municipality since all agreements with the Department would be with the local authorities and not with the developer. Please refer to [Use of Transportation Impact Study or Assessment](#) on Page 4-35 for additional information.

In some cases, the desire for a new traffic signal or a revision to or replacement of an existing traffic signal is initiated by the Department as part of a Department construction project. In these situations, a meeting with the local officials would also be desirable since the municipality will need to maintain and operate the signal, and they may be asked to fund a portion of the cost to install a new or revised traffic signal.

### Application by Local Authorities

If the local officials decide to pursue a new traffic signal or a revision to an existing signal, they will need to submit the following to the Department:

1. Signed and notarized Application for Traffic Signal Approval (TE-160).
2. A scaled drawing indicating the geometric and topographic features of the location.
3. A written financial commitment from the municipal governing body indicating that:
  - They will commit the appropriate funds to construct the signal installation within 2 years should the Department find that the installation meets warrants for a signal, and
  - The municipality will agree to operate and maintain the signal on an ongoing basis after the signal is installed in accordance with [§ 212.5](#) of Title 67 of the Pennsylvania Code (67 Pa. Code §212.5).
4. If a State highway is involved, they will enter into a Commonwealth and Municipal Traffic Signal Maintenance Agreement (see Appendix C of Publication 191), to maintain the traffic signal.

### Transfer of Authority to Local Authorities

#### Purpose

In accordance with [67 Pa. Code Chapter 205](#) (relating to municipal traffic engineering certification), municipalities can receive municipal traffic engineering certification (MTEC) which allows the local officials to install or modify traffic signals on locally owned roadways without prior approval of the Department. However, [§6122\(c\)](#) of the Vehicle Code also allows the Department to enter into an agreement with the local authorities to expand this approval to include traffic signals and other traffic control devices on State owned roadways without specific Department approval.

Therefore, the purpose of this section is to establish criteria and guidelines governing the Department entering into a Transfer of Authority (TOA) agreement with local authorities to authorize them to install official traffic control devices along highways and at intersections of local highways and State highways without specific Department approval. One of the prerequisites for a TOA agreement is that a municipality

must have MTEC, but the TOA agreement greatly expands the local authority’s role as illustrated in [Exhibit 4-5](#).

**Exhibit 4-5 TOA Agreement Expands the MTEC Authorization**

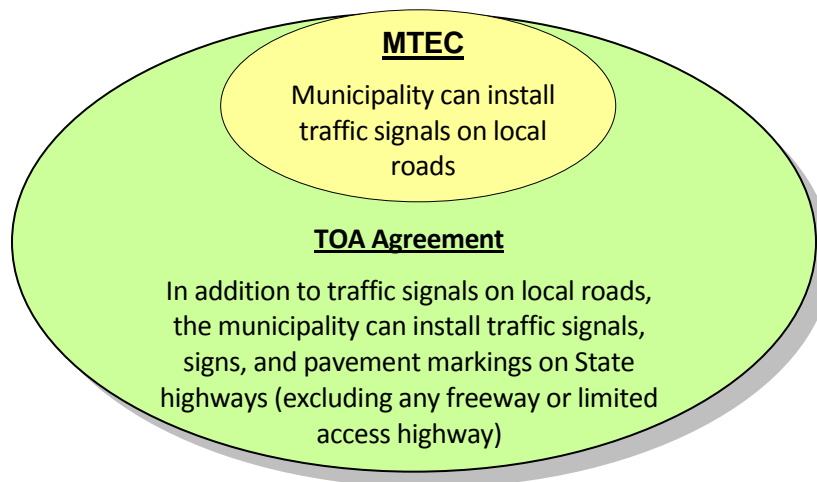

**Authorization**

[§6122](#) of the Vehicle Code provides the authority to erect traffic control devices along highways and defines the limits of this authority.

[§6122\(a\)](#) of the Vehicle Code indicates that local authorities may erect traffic control devices (except for traffic signals) on local highways and requires them to obtain approval of the Department prior to erecting official traffic control devices on State highways.

[§6122\(c\)](#) of the Vehicle Code provides the authority for the Department to enter into agreements with local authorities transferring to them the authority to install official traffic control devices without specific State approval provided they conduct engineering and traffic studies which conform with the rules and regulations promulgated by the Department.

**Criteria**

The Department may consider entering into a TOA agreement with a municipality transferring to them the authority to install, revise, remove, maintain, and operate official traffic control devices on State highways and at intersections of local highways and State highways provided:

- a) The municipality has a full-time municipal traffic engineer who is an employee of the municipality, and the municipality has received municipal traffic engineering certification (MTEC) in accordance with [67 Pa. Code Chapter 205](#) (relating to municipal traffic engineering certification).
- b) The municipality agrees that they will not perform the following without Department approval:
  - i. Revise or remove any traffic control device installed as a part of any Department-administered, federally-funded project.
  - ii. Install, revise, or remove any traffic control device on a freeway or other limited access highway, or within the limits of any Department construction project.
- c) The municipality agrees to conduct the necessary engineering and traffic studies in accordance with 67 Pa. Code Chapter 212 and the [MUTCD](#), and to base their traffic restrictions on State highways

and at the intersection of local highways and State highways on the findings and results of the engineering and traffic study.

- d) The municipality agrees to meet all current Department regulations, standards, and policies related to the design, location, and operation of official traffic control devices.
- e) The municipality agrees to make every effort within their financial capabilities to upgrade all traffic control devices to meet the current requirements of the [MUTCD](#), 67 Pa. Code Chapter 212, and [Publication 236](#).
- f) The municipality agrees to retain in their files:
  - 1. All data collected as a result of engineering and traffic studies which provide the justification for the installation, revision, or removal of the device.
  - 2. A completion certificate signed by the municipal traffic engineer verifying the completion of the installation, revision, or removal of official traffic control devices or a work order approved by the municipal traffic engineer when issued and countersigned by the individual responsible for installation, revision, or removal of the traffic control devices when the required work is completed.
  - 3. A schedule and results of periodic evaluations (at least yearly) of all official traffic control devices within the municipal boundaries including warranted update or revision recommendations.
  - 4. A plan of all traffic signals within the municipal boundaries to include a plan view of each traffic signal installation; mode of operation and, if applicable, a movement, sequence, and timing diagram; traffic flow diagram of peak hour volumes; and a collision diagram for the 3-year period preceding the traffic signal installation or latest traffic signal update.
- g) The municipality agrees that the Department's review and approval is required for the installation, revision, removal, maintenance, and operation of an official traffic control device at or near the boundary of another political subdivision unless the municipality accepts responsibility for the design of the project and the other political subdivision has given approval.
- h) The municipality agrees to indemnify and save harmless the Commonwealth, the Department, their officers, agents, and employees from all suits, actions, or claims of any character, name, and description brought for or on account of any injuries, deaths, or damages received or sustained, during the performance of the municipality's obligations under the agreement, by any person, persons, or property, by or from the municipality, whether the same be due to the use of defective materials, defective workmanship, neglect in safeguarding the work on public interests, or by or on account of any act, omission, neglect, or misconduct of the municipality during the performance of said work.

### Application Procedure

If local authorities desire to enter into a TOA agreement with the Department, the Engineering District or the municipality should request an application package from BOMO. In addition to instructions, BOMO will provide blank copies of the TOA agreement for execution.

The request from a municipality must include the following:

- a) A copy of the municipal traffic engineering certification (MTEC).

- b) A resolution from the governing body of the municipality authorizing the execution of the TOA agreement.
- c) Three original TOA agreements properly executed by the municipality (copy to be provided by the Department).

**Approval**

When a request to enter into a TOA agreement is received from a municipality, the Bureau of Maintenance and Operations (BOMO) will review the request to determine if the necessary documents are included and properly executed.

In addition to reviewing the application, BOMO will ask the Engineering District to make a cursory review in the municipality to determine if the application of traffic control devices on local roads appears to conform to MUTCD and Department regulations and standards. The Engineering District may also ask to view municipal records to verify that they perform engineering and traffic studies and maintain an acceptable filing system.

If application and the Engineering District's field view and personal knowledge of the municipality's abilities are acceptable, BOMO will process the request.

If the request is denied, the Department will not reevaluate a new request for another 12 months.

**Rescission**

If the municipality's municipal traffic engineering certification (MTEC) is rescinded, then the TOA agreement is automatically rescinded at the same time.

In addition, non-compliance by the municipality with any provision of the TOA agreement shall be a breach of the agreement and, at the Department's option, may be cause for immediate termination of the agreement.

If the Department rescinds the TOA agreement, BOMO will provide the municipality with a written notice stating the effective date of, and the reasons for, the rescission of the agreement. From that point on, the municipality shall follow all normal Vehicle Code requirements and Department regulations, standards, and procedures governing the installation of official traffic control devices along State highways and at intersections of local and State highways. Specifically, the municipality will need Department approval for the installation, revision, and removal of all signals on State highways and at intersections of local and State highways.

## 4.3 Traffic Signal Warrants and Engineering Studies

### General

Determination of the need to install, revise, or remove a traffic signal shall be based on a thorough engineering and traffic study of roadway and traffic conditions in accordance with 67 Pa. Code Chapter 212. Responsibilities shall be as follows:

- a) State Highways. The Engineering District will conduct studies at locations that involve State highways except for first and second class cities, municipalities having municipal traffic engineering certification, municipalities having an agreement with the Department, or for locations involving a business development. In these latter cases, the study will be conducted by that particular entity. When the Department completes a traffic signal study at the request of a municipality and determines that a traffic signal warrant is satisfied, the municipality shall be responsible to design the proposed traffic signal, prepare the bid documents, and prepare the traffic signal permit drawing. The proposed signal design, bid documents, and traffic signal permits shall be reviewed and approved by the Department prior to the project being advertised for bid by the municipality.
- b) Local Highways. Local authorities shall be responsible for conducting all studies for traffic signals at locations that do not involve State highways.
- c) Business Development. In accordance with Chapter 441, Section 441.6(4)(i) and Publication 282, developers shall be responsible for all studies necessary to justify traffic signals requested on any type of highway as a result of the traffic demands at a new or existing development.
- d) Department Coordination. Regardless of the party that conducts the study for traffic signals, the Department is required to approve the traffic signal by the issuance of a Traffic Signal Permit except for those municipalities having municipal traffic engineering certification and in accordance with an agreement with the Department.
- e) Plan. A scale drawing that depicts the geometric and topographic features of the location must be submitted with every completed traffic signal application form. The drawing shall be prepared in compliance with Publication 149 and other guidelines provided by the Department. The applicant shall be responsible for developing the drawing unless the signal installation is part of a Department construction project; in which case, the Department will develop the drawings as part of the project.
- f) Costs. All costs related to these studies shall be the responsibility of the entity conducting the study as indicated above.

### Traffic Control Signal Warrants

There are eleven (11) warrants for traffic signals, which are as identified in 67 Pa. Code §212 (relating to warrants for traffic control signals). Warrants 1 through 9 are as defined in Sections 4C.02 through 4C.10 in [Part 4 of the MUTCD](#), and the tenth and eleventh warrants as defined in 67 Pa. Code [§212](#).

**All eleven (11) warrants should be performed or considered when justifying a traffic signal. If a warrant is not applicable, this should be clearly stated within the traffic engineering study.**

The eleven warrants, and in some cases clarifying information, are as follows:



**Warrant 1, Eight-Hour Vehicular Volume**

The Minimum Vehicular Volume, Condition A, is intended for application at locations where a large volume of intersecting traffic is the principal reason to consider installing a traffic control signal.

The Interruption of Continuous Traffic, Condition B, is intended for application at locations where Condition A is not satisfied and where the traffic volume on a major street is so heavy that traffic on a minor intersecting street suffers excessive delay or conflict in entering or crossing the major street.

It is intended that Warrant 1 be treated as a single warrant. If Condition A is satisfied, then Warrant 1 is satisfied and analyses of Condition B and the combination of Conditions A and B are not needed. Similarly, if Condition B is satisfied, then Warrant 1 is satisfied and an analysis of the combination of Conditions A and B is not needed.

For full details on Warrant 1, see Section 4C.02 of the [MUTCD](#).

**Warrant 2, Four-Hour Vehicular Volume**

The Four-Hour Vehicular Volume signal warrant conditions are intended to be applied where the volume of intersecting traffic is the principal reason to consider installing a traffic control signal.

For full details on Warrant 1, see Section 4C.03 of the [MUTCD](#).

**Warrant 3, Peak Hour**

The Peak Hour signal warrant is intended for use at a location where traffic conditions are such that for a minimum of 1 hour of an average day, the minor-street traffic suffers undue delay when entering or crossing the major street. **Central Office approval is required if Warrant 3 is the only traffic signal warrant that can be met.**

For full details on Warrant 1, see Section 4C.04 of the [MUTCD](#).

**Warrant 4, Pedestrian Volume**

The Pedestrian Volume signal warrant is intended for application where the traffic volume on a major street is so heavy that pedestrians experience excessive delay in crossing the major street.

For full details on Warrant 1, see Section 4C.05 of the [MUTCD](#).

**Warrant 5, School Crossing**

The School Crossing signal warrant is intended for application where the fact that school children cross the major street is the principal reason to consider installing a traffic control signal. For the purposes of this warrant, the word "school children" includes elementary through high school students.

In addition to the criteria in Section 4C.06 of the [MUTCD](#), to satisfy Warrant 5 at an established school crossing, it is necessary to perform a traffic engineering study to determine the adequacy and frequency of vehicular traffic gaps. Guidelines for these "gap acceptance studies" are as follows:

- a) Conduct gap studies in accordance with the procedures developed in the Institute of Transportation Engineer's publication, "School Trip Safety Zone Guidelines," 1984 Edition.
- b) The study shall cover all times during the day when children use the crossing. This will involve, as a minimum, a morning and an afternoon study period.

- c) Each study period must be a minimum of 30 minutes in length; however, the study period should cover the entire time period the children use the crossing.
- d) Analyze locations where a median is involved in accordance with the following:
  - 1. Median width of 6 feet or less: This median width is not sufficient to provide adequate protection for the pedestrian; therefore, the width of the school crossing is from curb to curb.
  - 2. Median width greater than 6 feet to a maximum of 16 feet: This width may be sufficient for adequate pedestrian protection. Determine adequacy during the study based on the number of pedestrians, the speed of traffic, the type of median, etc.
  - 3. Median width greater than 16 feet: This size median is sufficient for adequate pedestrian protection. In this case, the width of the school crossing is from the curb to the median.

Justification for the installation of a signal under Warrant 5 requires the local officials or school officials to submit the following:

- a) Documentation clearly showing that the proposed signal installation is located at an established school crossing. A map of the local school area or municipality showing all established school crossings is desirable.
- b) A response to the following questions:
  - 1. Is it possible to relocate the school crossing to eliminate the need for a traffic signal?
  - 2. Can adult crossing guards or police officers more efficiently and safely control the school crossing?
- c) A completed "gap acceptance study" detailing the method of study with supporting data and analysis in the format described in the ITE publication referenced above. This study must show that the number of adequate gaps in the traffic stream during the period when the children are using the crossing is less than the number of minutes in the same period.

The design of signals installed under Warrant 5 shall include the following:

- a) Pedestrian-control signals.
- b) If at an intersection, the signal must be both traffic and pedestrian actuated.
- c) If installed within the limits of a progressive signal system, the signal must be interconnected with the system so that the timing does not disrupt the progressive movement.
- d) If installed at a non-intersection crossing, the signal shall be pedestrian-actuated. Parking and other obstructions to sight distance should be prohibited for at least 100 feet in advance of and 20 feet beyond the crosswalk.

The installation of traffic signals at school crossings may not be the absolute solution to the problem of conflicts between vehicles and school children. School and local traffic authorities must be aware of their responsibility to properly instruct children in the use of traffic signals. Moreover, the installation of a signal under the school crossing warrant does not preclude the use of school crossing guards.

#### **Warrant 6, Coordinated Signal System**

Progressive movement in a coordinated signal system sometimes necessitates installing traffic control signals at intersections where they would not otherwise be needed in order to maintain proper platooning of vehicles.

For full details on Warrant 6, see Section 4C.07 of the [MUTCD](#).

### **Warrant 7, Crash Experience**

The Crash Experience signal warrant conditions are intended for application where the severity and frequency of crashes are the principal reasons to consider installing a traffic control signal.

In addition to the criteria pertaining to Warrant 7 in Section 4C.08 of the [MUTCD](#), the five or more reported crashes of types susceptible to correction that occur within a 12-month period may include both reportable crashes and non-reportable crashes that are documented in the police files, and that occurred within a 12-month period during the most recent 3 years of available crash data.

### **Warrant 8, Roadway Network**

Installing a traffic control signal at some intersections might be justified to encourage concentration and organization of traffic flow on a roadway network.

To qualify under Warrant 8 in Section 4C.09 of the [MUTCD](#), a major route must be classified as an Urban Extension, Principal Arterial, or Minor Arterial that is a reasonable connection between two Principal Arterials and/or Urban Extensions as shown on the official Functional Classification Map.

To be justified under this warrant, a copy of the location as it appears on the Functional Classification Map, with approval date along with the federal-aid route numbers, must be submitted with the request for traffic signal approval.

### **Warrant 9, Intersection Near a Grade Crossing**

The Intersection Near a Grade Crossing signal warrant is intended for use at a location where none of the conditions described in the other eight traffic signal warrants are met, but the proximity to the intersection of a grade crossing on an intersection approach controlled by a STOP or YIELD sign is the principal reason to consider installing a traffic control signal.

For full details on Warrant 9, see Section 4C.10 of the [MUTCD](#). Also, if a traffic signal is warranted, the Department must involve the Public Utility Commission (PUC) as indicated in the section [Traffic Signals near Grade Crossings](#) on page [4-50](#).

### **Warrant PA-1, ADT Volume Warrant**

An “ADT volume warrant” is added in Section 212 and may be used in addition to the nine warrants contained in Sections 4C.02 through 4C.10 of the [MUTCD](#) (relating to Warrants 1 through 9). This warrant must apply at a proposed intersection, an intersection revised by a highway construction project, or at the driveway of a proposed commercial or residential development where vehicle counts cannot be taken. If a traffic-control signal is installed under this warrant, a traffic count must be taken within 6 months of the opening of a development or within 2 years of the opening of a highway. If the traffic volumes do not satisfy this warrant, or one or more of the other nine warrants, consideration should be given to removing the traffic-control signal and replacing it with appropriate alternative traffic-control devices, if any are needed.

This warrant is satisfied when the estimated ADT volumes on the major street and on the higher volume minor street or driveway approach to the intersection, when projected using an accepted procedure such as put forth in the latest Trip Generation Manual published by the Institute of Transportation Engineers, equals or exceeds the values in either Condition A or Condition B of the tables found within the warrant.

See Section 212 at <http://www.pacode.com/secure/data/067/chapter212/s212.302.html> for full details on this warrant.

**Warrant PA-2, Optional Traffic Signal Warrant for Midblock Crossings and Trail Crossings**

The guidelines below for the “Optional Traffic Signal Warrant for Midblock Crossings and Trail Crossings” (see [Exhibit 4-6](#) and [Exhibit 4-7](#)) requires the approval of the appropriate District Traffic Engineer prior to performing the analysis. The intent of this warrant is to evaluate a traffic control device in locations where safety concerns may exist at a midblock or trail crossing. Since the Department will not permit the use of the Pedestrian Hybrid Beacon, the following will provide an alternative to handling these challenging unique situations. The traffic signal must be at least 100’ away from other intersections.

Additionally, parking and other sight obstructions should be prohibited for at least 100 feet in advance of and at least 20 feet beyond the marked crosswalk, or site accommodations should be made through curb extensions or other techniques to provide adequate sight distance. Suitable standard signs and pavement markings should be installed in accordance with PennDOT Publication 149 “Traffic Signal Design Handbook”.

If this is the only traffic signal warrant that is met than a reevaluation of this warrant shall occur every 5 years. If it is determined that the signal is no longer needed then the traffic signal removal process should begin.

In addition to the information found in this warrant, signal spacing should be considered (i.e., how will this new installation fit in with adjacent intersections). In addition, other treatments such as pedestrian activated flashers should be installed first and if non-effective consider this warrant.

**Exhibit 4-6 Guidelines for Optional Traffic Signal Warrant for Midblock Crossing and Trail Crossings (Low-Speed Roadways)**

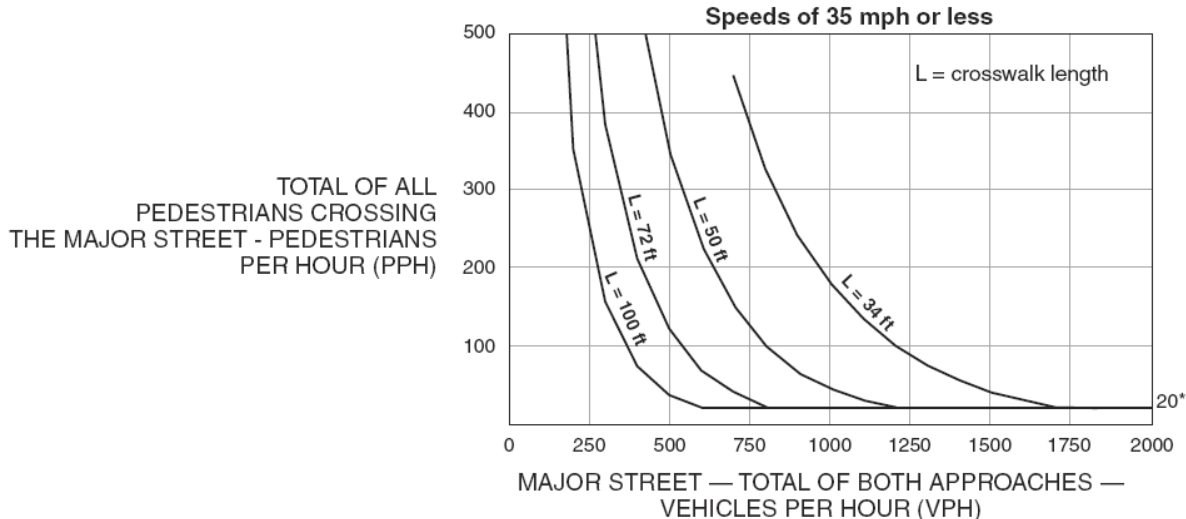

\* Note: 20 pph applies as the lower threshold volume

**Exhibit 4-7 Guidelines for Optional Traffic Signal Warrant for Midblock Crossing and Trail Crossings (High-Speed Roadways)**

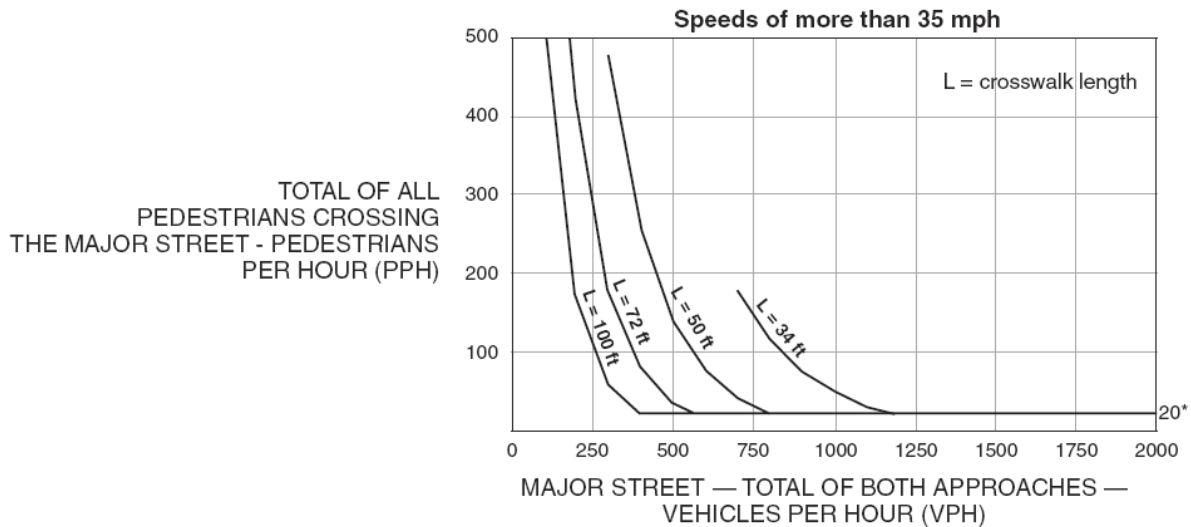

\* Note: 20 pph applies as the lower threshold volume

**Intersection Control Beacon Warrants**

Flashing beacons at intersections include intersection control beacons mounted on span wire directly over an intersection, stop beacons mounted on a pedestal above stop signs (red), and warning beacons mounted on a pedestal above intersection ahead symbols signs (yellow). Both overhead and pedestal mounted beacons have advantages and disadvantages. Overhead beacons may distract the motorist from roadway signing, but they aid the motorist in locating the intersection. Pedestal mounted beacons help draw attention to stop and intersection ahead signing, but do not help locate the intersection for the mainline driver who sees only flashing yellow mounted on an intersection ahead sign, somewhere in advance of the intersection itself. In any case, any flashing beacon must be justified under one or more of the following warrants. **The District Traffic Engineer will determine if an intersection Control Beacon is appropriate based on the warrants supplied below.**

**WARRANT 1: Limited Visibility**

Where sight distance is limited, a flashing beacon may be installed if the sight distance is less than that shown in [Exhibit 4-8](#) for any approach to the intersection. Locations qualifying under limited visibility must have previously had adequate warning signs and pavement markings installed.

**Exhibit 4-8 Intersection Flashing Beacon Limited Visibility Warrant**

Speed (mph)	Sight Distance Less Than (Feet)
20	105
25	145
20	195
35	250
40	320
45	390
50	460
55	540
60	635
65	745
70	840

NOTE: The distances here are to ensure the driver (3.5 ft. height of eye) who cannot see an oncoming vehicle (3.5 ft. height of object), has enough time to react and make a stop. They are based on AASHTO Policy for stopping sight distance (page 120) providing a Perception, Identification, Emotion, and Volition (PIEV) time of 2.5 seconds, friction factor of 0.28 to 0.40 based on speed.

**WARRANT 2: Crash Rate**

A flashing beacon may be installed where high-hazard safety improvement criteria are met, as described elsewhere in this manual or, in one year where there have been four or more crashes of the right-angle or left-turn type, or of the type deemed preventable by a flashing beacon. For appropriate crash rates, please consult the district traffic engineer.

**WARRANT 3: School Crossing**

A flashing beacon may be installed at an established school crossing where, during the heavy crosswalk usage periods, there are more than 500 vehicles per hour (actual or effective rate) crossing the crosswalk, and, insufficient usable gaps for pedestrians using the crosswalk.

**WARRANT 4: Rural Trunk Highway Junctions**

At or near some rural junctions of two or more high speed highways, a flashing beacon may be installed to warn drivers of an unexpected crossing of another highway.

**Flashing Beacons Guidance**

**Advanced Warning Beacons/Flashers and Internally Illuminated Advanced Warning Signs**

The following guidelines indicate when the installation of an Advanced Warning Flasher (AWF) or Internally Illuminated Warning Sign (IIWS) for signal change interval may be considered. Due to the complex nature of traffic flow characteristics, these guidelines should be applied along with engineering judgment. Guidelines should be reviewed for each prospective installation. **The District Traffic Engineer will determine if an AWF or IIWS is appropriate based on the warrants supplied below.**

**Exhibit 4-9      Advanced Warning Flasher and Internally Illuminated Warning Sign**



Advanced Warning Flasher (AWF)

Internally Illuminated Warning Sign (IIWS)

AWF or IIWS should only be installed in response to a specifically correctable problem, not in anticipation of a future problem. Generally, AWF or IIWS implementation is appropriate only at high speed locations. Before an AWF or IIWS is installed, other remedial action should be considered.

The following guidelines (see [Exhibit 4-10](#)) generally apply only where posted speed is 55 mph or higher.

**Exhibit 4-10      AWF and IIWS Criteria Guidelines**

<u>CATEGORY</u>	<u>CRITERIA</u>	<u>COMMENT</u>
1. Isolated or Unexpected signalized intersection	Where there is a long distance from the last intersection at which the mainline is controlled, or the intersection is otherwise unexpected.	This guideline may be applicable where the distance from the last intersection is greater than 10 miles, or at a freeway terminus, or at other locations where the intersection is unexpected.

CATEGORY	CRITERIA	COMMENT
<p>2. Limited sight distance</p>	<p>Where the distance to the stop bar, D, with two signal heads visible is insufficient:</p> $D \leq 1.467vt + \frac{v^2}{0.93(a + 32.2s)}$ <p>Where:</p> <p>D = distance to stop bar feet</p> <p>v = posted speed in mph</p> <p>t = reaction time, 2.5 seconds</p> <p>a = deceleration rate</p> <p>8 ft/s<sup>2</sup> (trucks)</p> <p>10 ft/s<sup>2</sup> (all traffic)</p> <p>s = decimal gradient</p>	<p>See Graphs of Limited Sight Distance, <a href="#">Exhibit 4-11</a> &amp; <a href="#">Exhibit 4-12</a>. A sight distance falling below the lines for the given speed and grade indicates the possible need for AWF or IIWS.</p>
<p>3. Dilemma Zone</p>	<p>Where a dilemma zone exists for all traffic or for heavy vehicles. A dilemma zone exists if:</p> $Y \leq t + \frac{1.467v}{2(a + 32.2s)}$ <p>Where:</p> <p>Y = yellow interval in seconds</p> <p>v = Posted speed in mph</p> <p>t = 1 second</p> <p>a = deceleration rate</p> <p>8 ft/s<sup>2</sup> (trucks)</p> <p>10 ft/s<sup>2</sup> (all traffic)</p> <p>s = decimal gradient</p>	<p>See Graphs on Minimum Yellow Intervals, <a href="#">Exhibit 4-13</a> &amp; <a href="#">Exhibit 4-14</a>.</p> <p>If the yellow interval is less than indicated, AWF or IIWS may be considered (longer yellow should be considered first).</p>
<p>4. Accidents</p>	<p>If an approach has an accident problem, the intersection should be examined for existence of dilemma zone or sight distance restriction.</p>	<p>If no sight distance or dilemma zone problems exist, AWF or IIWS may not be an appropriate countermeasure to accident problems.</p>
<p>5. Heavy Truck Volume</p>	<p>Where the roadway has a grade of 3% or greater and truck volume exceeds 15%.</p>	
<p>6. Engineering Judgment</p>		



Combinations of above guidelines or other considerations may justify the installation of AWF or IIWS.

Engineering judgment should be based on additional data such as complaints, violations, conformity of practice, and traffic conflicts. Prior to installing AWF or IIWS, consideration should be given to other countermeasures including but not limited to: adjustment of timing parameters which may include increasing yellow and/or all red intervals, improving detection, or modification of the signal system as by adding signal heads, adjusting speed limits.

**Guidelines for Installation of AWF or IIWS**

1. **Advanced Warning Flasher** - The flasher shall flash yellow in a (inside-outside) wig-wag manner prior to the termination of the green (See number 3, below), and during the yellow and red periods of the signal. The flasher will also flash if the signal goes into flashing operation. Power shall be supplied to the AWF or IIWS from the signal control cabinet.
2. **Advanced Warning Flasher Sign Placement** - The AWF or IIWS should be set back from the intersection in accordance with the table shown below. At locations on four lane divided roadway, the AWF shall be placed on both sides of the approach.

Posted Speeds (mph)	AWF or IIWS Placement	Leading Flash (seconds)
40*	560 ft	8.0
45*	560 ft	7.0
50*	700 ft	8.0
55	700 ft	7.0
60	850 ft	8.0
65	850 ft	7.5

\* Generally, an AWF or IIWS is installed for speeds of 55 MPH or higher. Use engineering judgment for speeds lower than 55 MPH.

3. **Leading Flash** - The Leading Flash is the amount of time, prior to the signal turning yellow, that the AWF flashes (or IIWS displays). The AWF shall flash (or IIWS should be illuminated) during the Leading Flash Period and continue flashing (illumination) through the signal's yellow clearance interval and the red. The Leading Flash time is shown in the table above.

For existing systems where the placement is other than what is listed in the table above, the Leading Flash Time can be computed by the following formula:

$$F = \frac{0.68D}{v} - 1.5$$

Where:

F = Leading Flash Time, seconds

- D = AWF (IIWS) Placement, feet
- v = posted speeds, mph

4. **Detector Placement** - The detection of the intersection shall be determined without regard to the AWF.

**Exhibit 4-11 AWF or IIWS Limited Sight Distance (> 15% Trucks)**

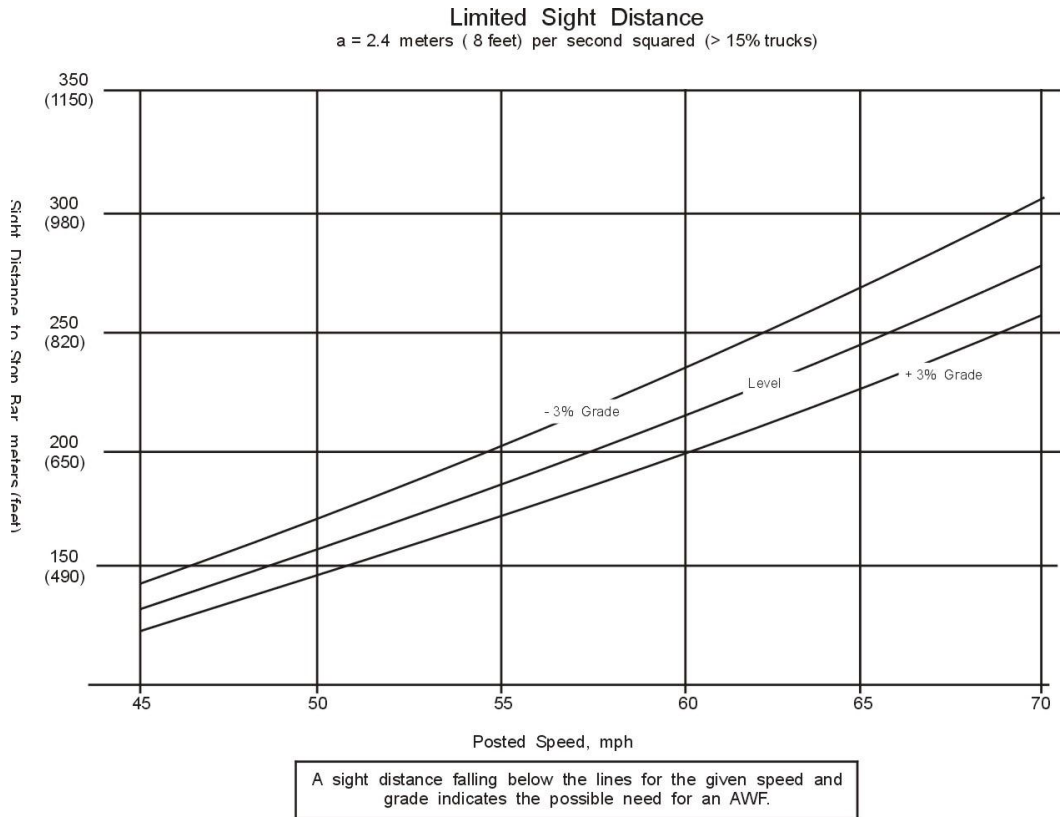

**Exhibit 4-12 AWF or IIWS Limited Sight Distance ( $\leq 15\%$  Trucks)**

Limited Sight Distance  
 $a = 3.0$  meters ( 10 feet) per second squared ( $\leq 15\%$  trucks)

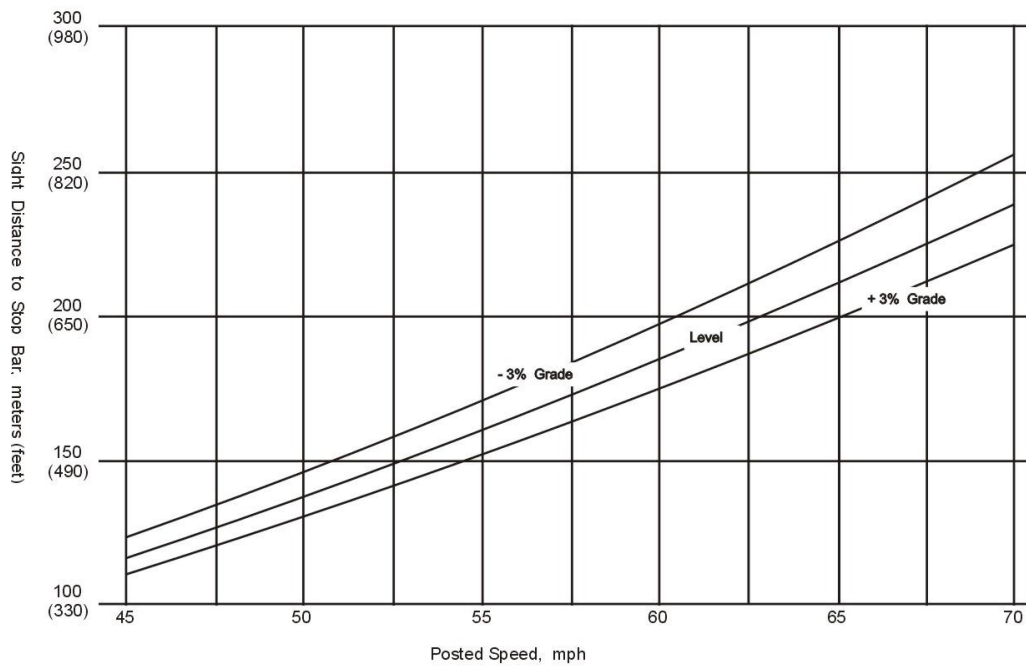

A sight distance falling below the lines for the given speed and grade indicates the possible need for an AWF.

**Exhibit 4-13 AWF or IIWS Recommended Yellow Intervals (> 15% Trucks)**

Recommended Yellow Intervals  
 $a = 2.4$  meters (8 feet) per second squared (> 15% trucks)

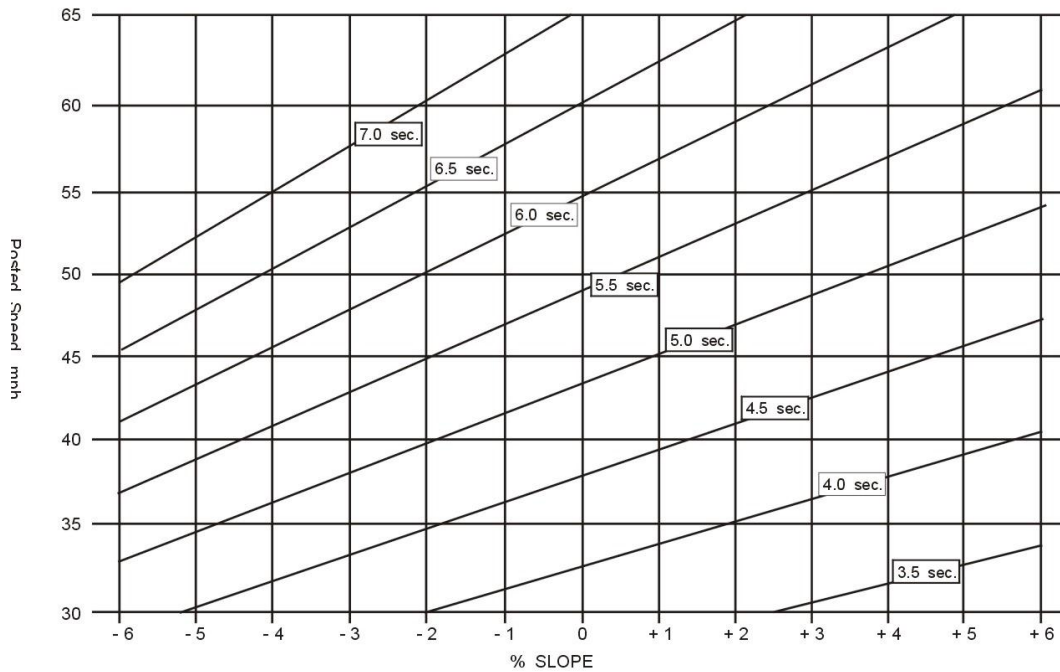

if the yellow interval is less than indicated, an AWF may be considered, (longer yellows should be considered first).

**Exhibit 4-14 AWF or IIWS Recommended Yellow Intervals ( $\leq 15\%$  Trucks)**

Recommended Yellow Intervals  
 $a = 3.0$  meters (10 feet) per second squared ( $> 15\%$  trucks)

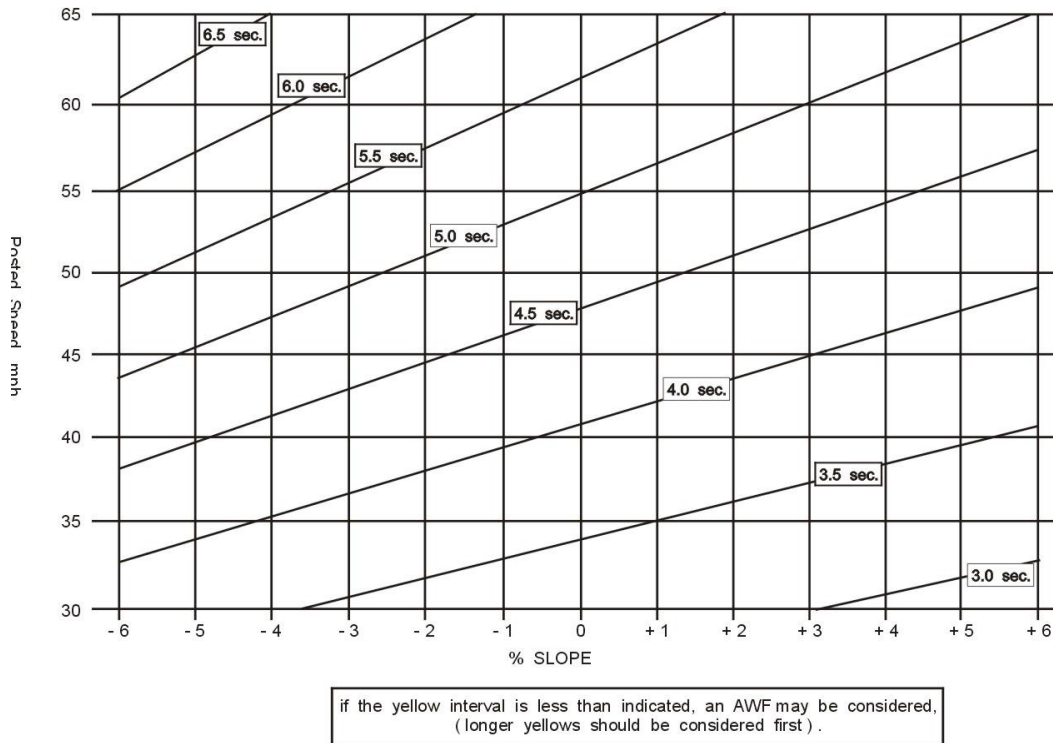

**Warning Beacons**

Consult the MUTCD 2009 Edition Chapter 4L.03 for information on warning beacons. Typical applications of Warning Beacons include the following:

- At obstructions in or immediately adjacent to the roadway;
- As supplemental emphasis to warning signs;
- As emphasis for midblock crosswalks;
- As supplemental emphasis to regulatory signs, except STOP, DO NOT ENTER, WRONG WAY, and SPEED LIMIT signs; and
- In conjunction with a regulatory or warning sign that includes the phrase WHEN FLASHING in its legend to indicate that the regulation is in effect or that the condition is present only at certain times.

**School Warning Beacons and School Speed Limit Sign Systems**

The Department’s Publication 149 – Traffic Signal Design Handbook includes details on the school zone speed limit sign and flashing warning device details. Refer to Publication 149 for information. In addition, see the MUTCD 2009 edition Sections 4L.04 and 7B.15.

**Exhibit 4-15 School Speed Limit Sign System**



**Other Warning Device Systems**

Consult the MUTCD 2009 Edition Chapter 4L for information on other warning beacons. [Exhibit 4-16](#) is a picture of a Curve Ahead warning system.

**Exhibit 4-16 Curve Ahead Warning System**



**Ramp Metering Guidance**

(Reserved)

**In-Roadway Warning Lights**

In-roadway warning lights (IRWL) are a special type of highway traffic signal installed in the roadway surface to warn road users that they are approaching a condition on or adjacent to the roadway that might not be readily apparent and might require the road users to slow down and possibly come to a stop.

In-roadway warning lights may be considered (on a project-by-project basis) for use at marked school crosswalks, marked midblock crosswalks, and other roadway situations involving marked pedestrian crossings. They shall not be used at crosswalks controlled by “Yield” signs, “Stop” signs, or traffic control signals. [Exhibit 4-17](#) is a picture of an In-Roadway Warning Light system.

**Exhibit 4-17 In-Roadway Warning Lights**



Additional details on IRWL can be found at:

[ftp://ftp.dot.state.pa.us/transfer/Traffic%20Signals/Product%20Specifications/Specification%20policy-%20IRWL%20\\_2-26-01\\_.pdf](ftp://ftp.dot.state.pa.us/transfer/Traffic%20Signals/Product%20Specifications/Specification%20policy-%20IRWL%20_2-26-01_.pdf)

**Rectangular Rapid Flashing Beacon Guidance**

Rectangular Rapid Flashing Beacon (RRFB) is a special type of traffic device to help aid in reducing pedestrian conflicts. This inexpensive device designed to increase yielding rates on multilane roads uses two pair of rectangular yellow LED beacons that employ a stutter flash pattern similar to that used on emergency vehicles. Previous studies have evaluated the effectiveness of the rectangular rapid-flash LED flash beacons mounted to pedestrian signs along with advance yield markings during daytime and nighttime operation with and without a median island or pedestrian refuge island. This device may be used as a tool at key locations where other safety tools have been tried. [Exhibit 4-18](#) is a picture of a RRFB.

**Exhibit 4-18 Rectangular Rapid Flashing Beacon**



Additional details, including a project work plan for the installation of the RRFB can be found at:

---

[ftp://ftp.dot.state.pa.us/transfer/Traffic%20Signals/Product%20Specifications/Retangular%20Rapid%20Flashing%20Beacons%20\(7-7-2009\).pdf](ftp://ftp.dot.state.pa.us/transfer/Traffic%20Signals/Product%20Specifications/Retangular%20Rapid%20Flashing%20Beacons%20(7-7-2009).pdf)

### **Pedestrian Study**

As specified in the MUTCD, Section 4E, an engineering study shall be conducted to determine the need for pedestrian accommodation at signalized intersections and the related design and operational features.

Based on an engineering study and engineering judgment, proper documentation shall be made at all new signalized intersections and modifications to existing signalized intersections. The documentation may be provided with guidance from the Pedestrian Needs Accommodation at Signalized Intersections Checklist in Publication 149.

### **Analysis of Data and Traffic Engineering Study**

In order to justify the need for a traffic signal or traffic signal modification, a traffic signal engineering study shall be completed. The traffic signal engineering study must be signed and sealed by a professional engineer licensed in Pennsylvania (for all projects, regardless of the funding). The goal of the study should be to determine if a traffic signal (or modification) is not just warranted at an intersection (or intersections) based on the MUTCD published warrants and Pennsylvania Code (Title 67) § 212.302, but indeed justified based on sound engineering judgment.

The [Frequently Asked Questions](#) page of the MUTCD states:

The MUTCD text in Section 4C.01 says "The satisfaction of a traffic signal warrant or warrants shall not in itself require the installation of a traffic control signal." It also says that an engineering study shall be done, and that the study shall include an analysis of those warrants "and other factors related to existing operation and safety" at the study location. Basically, the warrants are a starting point for the analysis leading to determination of justification for a signal, but engineering judgment must always be applied to assess all pertinent information in making the decision whether to signalize or not.

Taking the above into account, a comprehensive context-sensitive approach should be taken that examines all facets of potential traffic signal and intersection operations. Alternative traffic engineering solutions (e.g. roundabouts, roadway widening, pavement markings, signing, etc.) must also be considered and discussed as options prior to pursuit of a traffic signal installation. At a minimum, the following criteria and characteristics should be considered when completing the study:

[Note: Not all information listed below is necessarily required if the project is a modification to an existing traffic signal. The engineer should contact the municipality and/or the Department to discuss the scope of work for the traffic signal engineering study.]

### **Site Conditions**

- Roadway characteristics such as functional classification, lane widths, shoulder widths, truck percentages, curbing, and approach grades
- Prevailing vehicle speeds (a speed study should be completed to determine 85th percentile speeds)
- Sight lines for signal head visibility and for consideration of turn on red prohibition and protected-only left turn phasing
- Adjacent land uses and their traffic generating characteristics (vehicles and pedestrians)



- Presence of sidewalks
- Proximity to private residences
- Proximity to schools and churches
- Turning radii
- Driveways
- Nearest signals
- Presence of utilities
- Railroad grade crossings within 1,000 feet of the intersection

#### Traffic Data

- Turning movement counts for the AM, Midday, and PM peaks of a typical weekday (Tuesday through Thursday during a non-holiday week) or otherwise determined by the municipality and the Department. The data must be less than three years old at the time of the study completion.
- Additionally, for purposes of developing timing patterns, the data must be adjusted to the year in which the traffic signal or improvement is to become active.
- Turning movement counts for school arrival and dismissal periods if applicable and for any other special time period that is of concern to the engineer or to the party initiating the study or otherwise determined by the municipality and the Department. (e.g. Sunday church dismissal, movie theater discharge peaks, etc.)
- Pedestrian counts for the same periods
- 24-hour automatic traffic recorder counts if deemed appropriate to the needs of the study
- Pedestrian need evaluation
- Gap analysis (if applicable)

#### Crash Data

- The last five full years of available crash data, preferably reportable and non-reportable data collected from the Department and the local municipality.

The traffic signal engineering study should use the information listed above to complete the following analyses:

- A complete traffic signal warrant analysis in accordance with [67 Pa. C.S. §212.302] and with the guidance of TE-150 "Traffic Signal Warrant Analysis Engineering and Traffic Study" <ftp://ftp.dot.state.pa.us/public/PubsForms/Forms/TE-150.pdf>.
- A capacity analysis in accordance with Highway Capacity Manual procedures to determine the expected levels of service for the peak periods of the day. When using software to determine Highway Capacity analysis principals, please refer to approved Department's approved software platforms contained in PennDOT Publication 46, Chapter 12.
- Turn Lane evaluation should be in accordance with PennDOT Publication 46, Section 11.16.

- When considering left turn phasing needs, the analysis should be in accordance with Publication 149 "Traffic Signal Design Handbook"
- To determine if a traffic signal should be part of a coordinated system a progression analysis should be completed.
- Preliminary vehicle and pedestrian change and clearance interval calculations

The traffic signal engineering study should be signed and sealed by a professional engineer in the state of Pennsylvania and formatted with the following sections:

- I. Table of Contents
- II. List of Tables and Figures
  - A. Project Background
  - B. Existing Site Conditions
  - C. Data (traffic and crash)
  - D. Alternatives
  - E. Analysis and Calculations (warrant, capacity, phasing, progression, sight distance, change and clearance intervals)
  - F. Conclusions and Recommendations
  - G. Appendices (Form TE-150, raw data, pictures, analysis output, calculations, etc.)

The engineer conducting the study shall utilize the gathered information and analysis to draw a final conclusion and recommendation on whether or not a traffic signal (or modification) is justified based on the comprehensive approach discussed above. All assumptions and conclusions based on engineering judgment should be documented within the study.

#### **Use of Transportation Impact Study or Assessment**

Note that the use of a transportation impact study or assessment, which is generally considered a planning tool, is not necessarily sufficient for purposes of the traffic signal engineering study, unless the impact study considered the information described herein and was completed in such a manner as to appropriately draw a sound conclusion on the need for a traffic signal. The Department prefers that the study elements provided within this step be separate from the traffic impact study for these purposes.

#### **Department Participation**

In order to clarify the procedure followed to determine if a traffic signal installation qualifies for state and/or federal funding, the following shall be adhered to:

- a) Prior to the start of any signal design work, justification for the traffic signals shall be prepared by the design agency and reviewed by the District Traffic Engineer. If the traffic signal is justified, the District Traffic Engineer will process the traffic signal maintenance agreement. Final design should not start until the agreement is in place.
- b) Where existing traffic signals are in operation on State Highways and are affected by the Department's construction, the following information will be required to justify continued operation:

1. A copy of the condition diagram of the intersection, and the existing traffic signal permit drawing indicating the present signal operation and installation.
  2. A drawing indicating the proposed construction.
  3. Traffic volume data to justify continued signal operation (counts of existing and/or forecasted directional movements).
- c) Where the Department's construction creates a new intersection or involves an existing non-signalized intersection, the following information will be required to justify the installation of signals:
1. A drawing indicating the proposed construction.
  2. The anticipated traffic volume that will be entering that portion of the intersection to be controlled by the proposed signals. This estimated traffic volume must be that volume that will use the intersection when it is open to traffic or within a period of 2 years from the date of opening. Therefore, in evaluating the need for a traffic signal, the District Traffic Engineering Unit must obtain the estimated AADT of the intersection for the year the facility will be open to traffic. To determine the volume 2 years after the facility is opened, use a linear interpolation between the volumes expected to use the intersection when opened and the design year volumes. For existing intersections, use current volume counts.
- d) Consider any additional pertinent facts and information (such as school crossings, etc.) that the designer believes may be important in determining the need for a traffic signal.
- e) Compare the existing and projected traffic and other pertinent information with the warrants in Chapter 4C of the MUTCD and Section 4.3 in this publication, to determine if minimum criteria are satisfied.
- f) A further review of traffic conditions at the intersection should be made to determine if the need for traffic signals will be created by the Department's construction. If the construction is such as to create a substantial increase in traffic volumes or a definite change in the traffic flow, the Department will include the signal in the construction plan. A definite change in traffic flow is defined as:
1. An additional approach is added which provides for an immediate increase in cross traffic. (The creation of a full intersection that eliminates two offset intersections does not constitute an additional approach.)
  2. Where construction creates a marked increase in conflicting turning movements. (The creation of left-turn stand-by lanes by themselves does not constitute a marked increase in turning movements.)
- g) The Department may not participate if new development (industrial, commercial, recreational, residential, etc.) within the area is the prime traffic generator.
- h) The Department's policy is not to use State or federal funds to upgrade unwarranted signals, but the Department will allow the use of these funds to remove the signals. See Section 4.10 for a discussion on removing traffic signals.
- i) Signal systems are considered "ITS Projects." If funded with Federal Highway Trust Funds, they must comply with the DOT ITS Rule (23CFR, Parts 655 and 940).

### Vehicle Change and Clearance Intervals

In general, the vehicle change and clearance intervals should be dependent upon the approach speeds at the intersection and other factors. They should be sufficient to allow a motorist to safely bring his/her vehicle to a stop under normal conditions, or if he/she is too close to stop, then to proceed safely through the intersection.

Use the procedures contained in this section, along with engineering judgment, to determine the vehicle change and clearance intervals for each approach to a signalized intersection.

The Department uses the recommended ITE formulas for yellow and all-red clearance intervals to ensure compliance with the 2009 MUTCD requirement of using established engineering practices. If engineering judgment is used to vary from the established ITE formulas than this should be documented in the traffic signal file.

**Yellow Change Interval**

A yellow change interval should have a duration of approximately 3 to 6 seconds. The longer intervals should be reserved for use on approaches with higher speeds. Excessively long change intervals may result in abnormal running of the change and clearance intervals.

The yellow change interval should be calculated using the following equation:

$$Y = t + \frac{1.47V}{2a \pm 64.4g}$$

Where:

- Y = Yellow change interval; s (typically 3 to 6 seconds)
- t = Perception-reaction time; s (typically 1 second)
- V = Approach speed of the roadway; mph
- a = Deceleration rate; [typically 10 ft/s<sup>2</sup>]
- g = Grade of approach; %/100

Exhibit 4-19 provides yellow change intervals using the required information. (Refer to the following charts for informational purposes; document all calculations.)

**Exhibit 4-19 Yellow Change Interval**

	V (Approach Speed, mph)	g (Grade of Approach)												
		Uphill						Level	Downhill					
		6%	5%	4%	3%	2%	1%	0%	-1%	-2%	-3%	-4%	-5%	-6%
$t + \frac{1.47V}{2a \pm 64.4g}$	25	2.5	2.6	2.6	2.7	2.7	2.8	2.8	2.9	3.0	3.0	3.1	3.2	3.3
	30	2.8	2.9	3.0	3.0	3.1	3.1	3.2	3.3	3.4	3.4	3.5	3.6	3.7
	35	3.2	3.2	3.3	3.3	3.4	3.5	3.6	3.7	3.7	3.8	4.0	4.1	4.2
	40	3.5	3.5	3.6	3.7	3.8	3.8	3.9	4.0	4.1	4.3	4.4	4.5	4.6
	45	3.8	3.8	3.9	4.0	4.1	4.2	4.3	4.4	4.5	4.7	4.8	4.9	5.1
	50	4.1	4.2	4.3	4.4	4.5	4.6	4.7	4.8	4.9	5.1	5.2	5.4	5.6
	55	4.4	4.5	4.6	4.7	4.8	4.9	5.0	5.2	5.3	5.5	5.6	5.8	6.0
	60	4.7	4.8	4.9	5.0	5.1	5.3	5.4	5.6	5.7	5.9	6.1	6.3	6.5
	65	5.0	5.1	5.2	5.4	5.5	5.6	5.8	5.9	6.1	6.3	6.5	6.7	6.9

The perception-reaction time ( $t$ ) was assumed to be 1 second, and a deceleration rate ( $a$ ) of  $10 \text{ ft/s}^2$  was assumed.

**Yellow Interval for Left Turns**

When determining the yellow interval for left turns use 25 mph for the speed. If timing a single point urban interchange (SPUI) or an intersection with a wide, sweeping radius, assume a speed of 35 mph.

**All-Red Clearance Interval**

The yellow change interval should be followed by an all-red clearance interval to provide additional time before conflicting traffic movements, including pedestrians, are released.

The all-red clearance interval should be calculated using the following equation:

$$AR = \frac{(W + L)}{1.47V}$$

Where:

AR = All-red clearance interval; s

V = Approach speed of the roadway; mph

W = Width of intersection (from the stop bar to the end of the farthest traveled lane); (ft)

L = Length of vehicle, [typically 20 ft]

Refer to [Exhibit 4-20](#) for a graphical definition of the terms used in the all-red interval calculation.

**Exhibit 4-20 Definition of Terms for All-Red Clearance Intervals**

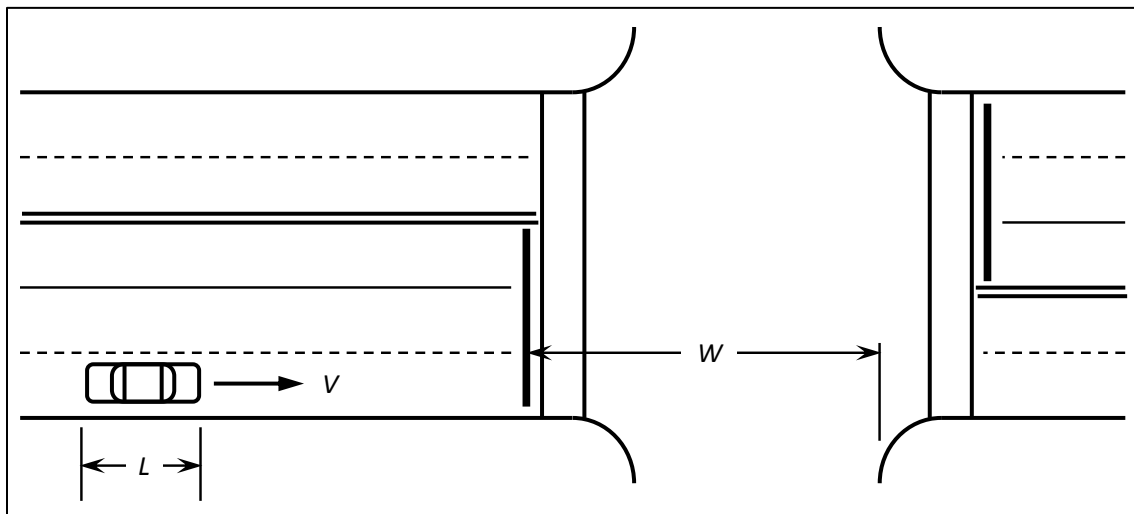

[Exhibit 4-21](#) provides all-red clearance intervals using the required information. (Refer to the following charts for informational purposes; document all calculations.)

**Exhibit 4-21 All-Red Clearance Interval**

	V (Approach Speed, mph)	W (Width of Intersection), ft										
		20	30	40	50	60	70	80	90	100	110	120
$\frac{W + L}{1.47V}$	25	1.1	1.4	1.6	1.9	2.2	2.4	2.7	3.0	3.3	3.5	3.8
	30	0.9	1.1	1.4	1.6	1.8	2.0	2.3	2.5	2.7	2.9	3.2
	35	0.8	1.0	1.2	1.4	1.6	1.7	1.9	2.1	2.3	2.5	2.7
	40	0.7	0.9	1.0	1.2	1.4	1.5	1.7	1.9	2.0	2.2	2.4
	45	0.6	0.8	0.9	1.1	1.2	1.4	1.5	1.7	1.8	2.0	2.1
	50	0.5	0.7	0.8	1.0	1.1	1.2	1.4	1.5	1.6	1.8	1.9
	55	0.5	0.6	0.7	0.9	1.0	1.1	1.2	1.4	1.5	1.6	1.7
	60	0.5	0.6	0.7	0.8	0.9	1.0	1.1	1.2	1.4	1.5	1.6
	65	0.4	0.5	0.6	0.7	0.8	0.9	1.0	1.2	1.3	1.4	1.5

The length of vehicle was assumed to be 20 feet.

**All Red for Left Turns**

For left turns, use a speed of 25 mph. If timing a single point urban interchange (SPUI) or an intersection with a wide, sweeping radius, assume a speed of 35 mph.

The width of the intersection, w, for a left turn is commonly determined from a scaled intersection drawing. This distance (w) is measured along the path of the left turn vehicle from the stop to the end of the farthest conflicting lane.

**Change and Clearance Intervals**

The change and clearance interval is the sum of the yellow change and all-red clearance intervals. The change and clearance interval should be calculated using the following formula:

$$CCI = Y + AR$$

AR = All-red clearance interval; s

Y = Yellow change interval; s

CCI = Change and clearance interval, s

**Pedestrian Intervals**

Refer to the MUTCD 2009 Edition Section 4E.06 Pedestrian Intervals and Signal Phases and Section 4E.07 Countdown Pedestrian Signals.

When pedestrian signal heads are used, a WALKING PERSON (symbolizing WALK) signal indication shall be displayed only when pedestrians are permitted to leave the curb or shoulder.

A pedestrian clearance time shall begin immediately following the WALKING PERSON (symbolizing WALK) signal indication. The first portion of the pedestrian clearance time shall consist of a pedestrian change interval during which a flashing UPRAISED HAND (symbolizing DONT WALK) signal indication shall be displayed. The remaining portions shall consist of the yellow change interval and any all-red clearance interval (prior to a conflicting green being displayed), during which a flashing or steady UPRAISED HAND (symbolizing DONT WALK) signal indication shall be displayed.

The pedestrian clearance time should be sufficient to allow a pedestrian crossing in the crosswalk who left the curb or shoulder during the WALKING PERSON (symbolizing WALK) signal indication to travel at a walking speed of 3.5 ft per second, to at least the far side of the traveled way or to a median of sufficient width for pedestrians to wait. The distance is typically measured in the middle of the crosswalk. Where pedestrians who walk slower than 3.5 ft per second, or pedestrians who use wheelchairs, routinely use the crosswalk, a walking speed of 3 ft per second should be considered in determining the pedestrian clearance time. A slower walking speed should be considered when near elementary schools and elderly facilities.

When countdown pedestrian signals are used, the numeric countdown signal indication shall be displayed only during the pedestrian change interval (flashing DONT WALK interval) and no numeric indication shall be visible during a steady upraised hand indication or walking person indication.

### WALK Interval

The WALK interval allows pedestrians to access the intersection and provides enough time for pedestrians to enter the crosswalk before the pedestrian change interval (flashing DONT Walk interval) commences. The walk interval should be at least 7 seconds in length so that pedestrians will have adequate opportunity to leave the curb or shoulder before the pedestrian clearance time begins. If pedestrian volumes and characteristics do not require a 7-second walk interval, walk intervals as short as 4 seconds may be used. Longer walk intervals are often used when the duration of the vehicular green phase associated with the pedestrian crossing is long enough to allow them.

### Pedestrian Change Interval (FLASHING DONT WALK)

The pedestrian change interval (flashing DONT WALK) allows pedestrians to clear the intersection approach, alerts pedestrians of an upcoming changing phase, and provides time for pedestrians to cross the intersection approach completely upon termination of the WALK interval.

Use the following equation to calculate the length of the pedestrian change (flashing DON'T WALK) interval:

$$T_{pc} = \frac{L}{S_w}$$

$T_{pc}$  = Pedestrian change ( flashing DON'T WALK) interval; s

$L$  = Pedestrian walking distance from the curb or edge of shoulder to the far edge of the traveled way; ft

$S_w$  = Walking speed; s [typically 3.5 ft/s]

### Total Duration of Walk Interval and Pedestrian Clearance Time

The total of the walk interval and pedestrian clearance time should be sufficient to allow a pedestrian crossing in the crosswalk who left the pedestrian detector [or, if no pedestrian detector is present, a location 6 ft from the face of the curb or from the edge of the pavement] at the beginning of the WALKING PERSON (symbolizing WALK) signal indication to travel at a walking speed of 3 ft per second to the far side of the traveled way being crossed. Any additional time that is required to satisfy the conditions of this paragraph should be added to the walk interval.

### Minimum Green Interval Without Pedestrian Signal Use

When pedestrian signal indications are not provided but pedestrian requirements are to be considered in the signal timing plan, the length of the green interval should, as a minimum, include sufficient time ( $T_p$ ) to

allow pedestrians to cross the roadway at a walking speed of 1.1 m (3.5 ft) per second, plus additional time (3 seconds) for starting at the beginning of the green.

$$T_p = \frac{L}{S_w} + 3$$

- $T_p$  = Minimum green interval without pedestrian signals; s
- $L$  = Pedestrian walking distance from the curb or edge of shoulder to the far edge of the traveled way; (ft)
- $S_w$  = Walking speed; s [typically 3.5 ft/s]

### Capacity Analysis

All studies for permits for new traffic signals, or for revised permits for existing signals that involve a change in timing, phasing, or type of controller operation, should include a complete capacity analysis for the intersection. For approved capacity analysis software platforms, please refer to [12 Traffic Engineering Software](#).

In addition, all studies for permits must comply with the Smart Transportation Guidebook (<http://www.smart-transportation.com/guidebook.html>).

### Simulation Model Calibration

Refer to Section **Error! Reference source not found.** - **Error! Reference source not found.** on page [Error! Bookmark not defined.](#)

### No Turn On Red Study

Section 2B.54 of the 2009 MUTCD states that a No Turn on Red sign should be considered when an engineering study finds that one or more of the following conditions exists:

- a) Inadequate sight distance to vehicles approaching from the left (or right, if applicable);
- b) Geometrics or operational characteristics of the intersection that might result in unexpected conflicts;
- c) An exclusive pedestrian phase;
- d) An unacceptable number of pedestrian conflicts with right-turn-on-red maneuvers, especially involving children, older pedestrians, or persons with disabilities;
- e) More than three right-turn-on-red accidents reported in a 12-month period for the particular approach; or
- f) The skew angle of the intersecting roadways creates difficulty for drivers to see traffic approaching from their left.

The following warrants may be used in addition to the warrants for no-turn on red restrictions in the MUTCD (relating to traffic signal signs).

- a) A right turn on red, or left turn on red from a one-way highway to another one-way highway, may be prohibited from an intersection approach where an engineering and traffic study indicates that one or more of the following conditions exist:



- i. The available corner sight distance between a driver desiring to turn on red and an approaching vehicle on the cross street is less than the minimum shown on the following table:

**Exhibit 4-22 No Turn on Red Minimum Site Distance**

Speed Limit or 85 <sup>th</sup> %ile Speed	Minimum Site Distance to Approaching Vehicle*						
	Std. Values	Cross Street Approach Grade					
		-9%	-6%	-3%	3%	6%	9%
25	152	173	165	158	147	143	140
30	197	227	215	205	200	184	179
35	247	287	271	257	237	229	222
40	301	354	333	315	289	278	269
45	360	427	400	378	344	331	320
50	424	507	474	446	405	388	375
55	493	593	553	520	469	450	433

\* Measure sight distance from a location 10 feet before a marked pedestrian cross walk or, if none, 10 feet from the edge of the cross street roadway or curb line, where both the eye and the approaching vehicle are 3.5 feet high.

- ii. The intersection has more than four approaches or has restrictive geometry that is likely to cause vehicular conflicts which are not easily recognized by drivers.
  - iii. The turning movement is allowed from more than one lane on a specific approach.
  - iv. The vehicular turning movement would result in significant vehicular and pedestrian conflicts, such as locations where the crosswalk is designated as a school crossing or is used by large numbers of children, senior citizens or persons with physical disabilities. A no-turn-on-red restriction at these locations may only apply during the time periods that significant vehicular-pedestrian conflicts would occur, in accordance with paragraph (3).
  - v. Opposing traffic has unusual movements, such as double left turns, which would not be expected by drivers turning on a red signal.
  - vi. An analysis of vehicle crash data indicates that the turn-on-red movement has created an unsafe condition.
- b) Part-time or intermittent prohibition of the turn-on-red movement must be used at locations where a potential safety concern exists for only a portion of the day. These restrictions must be implemented by the use of one or more of the following:
- i. A Restricted Hours Panel (R10-20A) under the No Turn On Red Sign.
  - ii. A supplemental message incorporated directly into the No Turn On Red Sign.
  - iii. A sign designating the hours the restriction is effective.
  - iv. A blank-out No-Turn-On-Red Sign.
- c) A part-time or intermittent prohibition of the turn-on-red movement may be used at an intersection approach where vehicles turning on red would cross an at-grade railroad crossing within 200 feet and the traffic signal controller is preempted during train movements during the time the signal controller is preempted in accordance with paragraph (2).

- i. Application. This section applies to signalized roadway and driveway intersections along all highways.
- ii. Engineering and traffic studies. Engineering and traffic studies required by subsection (a)(1) shall be conducted by local authorities. The Department will be responsible for conducting the study at the following locations:
  - i. At intersections where the traffic signal controller is preempted during train movements for a nearby crossing.
  - ii. At new or revised traffic signal installations when the traffic signal is designed by the Department.
- iii. Department approval. Written approval of the Department's district executive shall be obtained prior to installation of a No Turn on Red Sign (R10-11 Series) at any intersection where the Department has issued the traffic signal permit.

### Turn Restrictions

A straight-through or turning movement may be restricted if the movement can be made at an alternate location, and if one or more of the following conditions are present:

- a) A review of vehicle crashes shows that ten crashes have occurred during the previous 3 years, or five crashes have occurred during any 12-month period in the previous 3 years that can be attributed to vehicles making or attempting to make the movement.
- b) When a capacity analysis or field review of the intersection indicates that turning or crossing vehicles are causing unreasonable delays or creating a potential crash situation for through vehicles.
- c) When a field review of the intersection indicates that significant conflicts occur between vehicles making or attempting to make a particular movement and other vehicular or pedestrian movements.
- d) When a field review of the intersection indicates that a turn or straight-through movement delays the platoon of vehicles through a progressive signal system.
- e) When a field review of the intersection indicates that the geometric design or the available corner sight distance does not adequately provide for the movement or the movement frequently cannot be safely executed.
- f) A study shows that the turning movement is frequently being made by through traffic onto a residential street to avoid downstream congestion.

## 4.4 Permits

### General

Written Department approval is required before a traffic signal can be installed, revised, or removed on any State or local highway except for those local authorities given this responsibility as indicated in [§6122\(a\)\(2\)](#) and [§6122\(c\)](#) of the Vehicle Code and [§212.5](#) (specifically, subsections (b)(1)(ii)(B), (b)(1)(iii), and (c)(1)) of Chapter 212. Approval will be given only to local authorities, the Department, or contractors working for the Department if the location data satisfies state or federal traffic signal warrants.

### Authority for Issuing

#### Purpose

This policy establishes the authority and responsibility to review, issue, and cancel permits or approvals for traffic control devices and restrictions.

#### Authority

The District Executive, an Assistant District Executive, or the District Traffic Engineer, may issue or cancel permits or approvals for traffic control signals providing they have a Professional Engineer's License. The Bureau of Maintenance and Operations can provide advice and assistance in the area of permit issuance or cancellation upon request.

The Traffic Operations Section shall be responsible to approve traffic signal equipment and have approved materials listed in the [Approved Construction Materials](#) (Publication 35). In accordance with 67 Pa. Code [§212](#) (relating to traffic signal equipment requiring Department approval), items requiring approval include the following:

- Controller units (1104.03)
- Signal heads – lane-use traffic control, pedestrian, and vehicle (1104.06)
- Detectors – pedestrian and vehicle (1104.07)
- Load switches (1104.03)
- Flasher units (1104.03)
- Time clocks (1104.03)
- Relays (1104.03)
- Signal Housings - Pedestrian and Vehicle (1104.06)
- Preemption and priority control equipment (1104.07)
- Electrically-powered signs – variable speed limit signs, blank-out signs, and internally illuminated signs, including School Speed Limit Signs (1103)
- Portable traffic-control signals (1124)
- Local intersection coordinating units (1104.04)
- Adaptive Traffic Control Systems (requires BOMO approval)
- Dimming devices (requires BOMO approval)
- In-roadway warning lights (requires BOMO approval)
- Auxiliary devices and systems (requires BOMO approval)

### Procedures

In most cases, Engineering Districts do not need to submit traffic signal plans or special provisions to the Bureau of Maintenance and Operations (BOMO) for review and approval. On the other hand, traffic signal plans or special provisions may be submitted to BOMO on a case-by-case basis at the discretion of the Engineering District when they believe that a review by BOMO would be appropriate or helpful.

However, in accordance with current policies, the following additional reviews are required:

- a) BOMO. Submit traffic signal plans or special provisions to BOMO for approval before approval is issued by the Engineering District if the signals have alternate or experimental devices or procedures, such as red signal ahead signs, automated red light enforcement (ARLE), etc.
- b) Rail Safety Division of the Pennsylvania Public Utility Commission (PUC). Make a formal submission including the traffic signal plan to the PUC whenever there is a proposed change to an existing traffic signal with existing railroad preemption, or whenever train preemption is proposed at a new location.
- c) If the District Grade Crossing Engineer does not have authorization to make a direct submission, then the Engineering District should submit the formal application to the Central Office Grade Crossing Section in the Bureau of Project Delivery, and request them to submit the application to the PUC.
- d) Bureau of Project Delivery. In accordance with the Federal-Aid Highways Stewardship and Oversight Agreement, FHWA approval is required for signals included in FHWA oversight projects. Therefore, the Engineering District should submit traffic signal plans and special provisions for these projects to the Bureau of Project Delivery, who will then forward them to FHWA for approval in accordance with customary project development procedures. FHWA approval is not required for other signal installations provided that they conform to the MUTCD.

### Traffic Signal Permit

The appropriate municipal officials need to review and approve construction plans for traffic signals prior to the final review and approval by the Department. Local officials also need to review and sign all traffic signal permit diagrams prior to issuance by the Department. The purpose of this review is to obtain the municipality's concurrence with the proposal since they must operate and maintain the signals. The signature of the municipal engineer or other responsible official will indicate their concurrence with the proposal.

A permit data block must be located on the permit drawing to maintain a uniform record of all changes.

The District Traffic Engineering Unit should issue a signal permit for each new or revised signal under any program within a month of the bid award.

Forward a copy of the following approved traffic signal permits to the Traffic Operations Section:

- All new or revised permits involving railroad preemption.
- Any blanket portable traffic control signal permit.

### Recordkeeping

The office that issues the permit, certificate of approval, cancellation, or the approval or denial of requests for the installation of traffic control signals is responsible for maintaining a file, including all required documentation for the justification of the devices and an up-to-date record of the permit status. (This is particularly important for projects involving federal funding since the FHWA may audit these projects.)

In accordance with Department policies, each Engineering District shall retain in their files the following traffic signal-related items for a minimum of 2 years after cancellation or removal of the signal:

- Engineering and traffic studies.
- Municipal applications and agreements.
- Traffic signal permits and wiring diagrams, including all subsequent revisions.
- As-built construction plan sheets showing the applicable intersections.

#### 4.5 Traffic Signal Spacing

Appropriate signal spacing is needed to preserve efficient traffic flow and progression on urban arterial roadways; for instance, a quarter- or half-mile spacing allows traffic signals to be effectively interconnected and synchronized. Adequate spacing will also tend to reduce rear-end collisions and “stop and go” driving that increases congestion, delay and air pollution.

**Exhibit 4-23 Traffic Signal Spacing**

Roadway Classification	In Current and Projected Urban Areas	In Rural Areas
Major, Freeway	Traffic signals not allowed	Traffic signals not allowed
Major, Non-Freeway	½ mile (2,640 ft.) – 1 mile (5,280 ft.)	See note below*
Minor	¼ mile (1,320 ft.) - ½ mile (2,640 ft.)	See note below*
* Rural traffic signals are generally isolated signals rather than signals placed in a progression along a route. Signals are to be placed at least 5,280 ft. apart because of high rural operating speeds.		

The ideal spacing for traffic signals is at least one half-mile apart (2,640 feet). This represents about four to six blocks, depending on the block length. A minimum spacing of one-quarter mile (two to three blocks) should always be maintained. When the spacing between signals falls below one-quarter mile (1,320 feet), the traffic flow along the route may be disrupted. The ability of the route to carry through traffic will decrease, travel speeds may decrease, and delays and queues may develop at intersections. There is also some evidence from research that placing more than three traffic signals per mile on an arterial increases the traffic accident rate.

Prior to signal plans being developed, the District Traffic Engineer must approve the appropriate signal spacing.

#### Traffic Signal Coordination

To maximize the effectiveness of traffic signal coordination, the following factors should be considered: traffic signal spacing, traffic flow characteristics, and traffic signal cycle lengths. Although these factors are closely related to one another, they could be considered independently for evaluation.

The MUTCD states that traffic control signals within  $\frac{1}{2}$  miles of one another along a major corridor or in a network of intersecting routes should be considered for coordination. Other factors such as grades, curves, and operating speeds may also need to be considered in conjunction with signal spacing.

The goal of traffic signal coordination is to establish platoons or tight groups of vehicles that can move easily from one intersection through another without stopping. The ideal condition for establishing these platoons is to have the traffic signals uniformly spaced. When signals are spaced too far apart, traffic may not form these platoons thereby undermining the effectiveness of signal coordination. In addition, uneven or closely spaced traffic signals can also reduce the effectiveness of platoon formation therefore reducing arterial travel speeds, resulting in an excessive number of stops, even under moderate traffic volumes.

### **Coordination Advantages and Disadvantages**

Some of the advantages of traffic signal coordination are:

- Improves mobility and access through the area;
- Reduces vehicle accidents in the area;
- Reduces energy and fuel consumption;
- Reduces stops;
- May control travel speeds;
- Provides environmental benefits from reduced vehicle emissions; and,
- Ability to monitor daily traffic operations (UTCS and Closed-Loop).

Some of the disadvantages of traffic signal coordination are:

- May increase the waiting time (delay) for some side streets and left turn movements;
- Increase in travel speeds may have a negative impact in the community;
- May attract additional traffic through the corridor;
- Maintenance and equipment costs may be high based on the type of hardware and software used; and,
- Requires qualified staff for maintenance and monitoring of daily operations.

### **Traffic Signal Analysis Tools**

The previous sections discuss some of the factors to consider when determining if adjacent traffic signals should be coordinated along with some of the advantages and disadvantages to coordination. In addition to the elements previously mentioned, an engineering analysis with a traffic software tool should be considered.

For instance, the software package Synchro (see Section 12.2 on page 1) includes a tool called the Coordinatability Factor (CF) which can be used to assist in determining coordination needs. This feature considers the travel time between intersections (hence, considering distance and speed), the traffic volumes on the main street and side street, the natural cycle of the adjacent signals, and the storage space between the intersections. Using this information, Synchro will provide a score on the desirability of coordinating (or not coordinating) the adjacent intersections.

Along with the CF, a traditional analysis could be performed for the network with and without coordination using tools such as Transyt-7F, Synchro and SimTraffic. Network wide and arterial measures such as delay, travel time, fuel usages, emissions and others could be compared between the alternatives.

The above analysis would be used in helping shape the decision on whether to coordinate or not. However, engineering judgment should also be exercised when making the final decision and qualitative, along with the previously discussed quantitative measures need to be considered.

### Access Management

In addition to the above information, refer to Pa. 67 Chapter 441 for information on Access to and Occupancy of Highways by Driveways and Local Roads.

## 4.6 Design

### General

Signal design encompasses a variety of items which must be considered prior to and during the development of traffic signal permit drawings, construction plans, and specifications. Drawings and specifications define the proposed work to ensure that the traffic signals will operate in a safe and efficient manner. Drawings include those items required by regulations, including, but not limited to, a plan view of the location, traffic signal layout, phasing diagram, timing plans, required signing and markings, construction details, and tabulations.

### Traffic Signal Design Handbook

The Department's official design manual is the Traffic Signal Design Handbook ([Publication 149](#)). Publication 149 states:

"This Handbook is to be used as a guide for the design and operation of a traffic signal installation. The guidelines established in this Handbook may be used to design new traffic control signals and existing traffic control signal features that are to be modified."

Signal designers should meet and confer to agree on preliminary signal design. The design topics to be discussed include the following (refer to publication 149):

- The general nature of the signal project: new installation, minor or major revisions.
- Phasing of the intersection, relation of proposed phasing to the traffic volumes and turning movements; use of protected-permissive left turn phasing rather than protected-only; use of overlaps.
- Use of 4- and 5-section heads and non-standard bracketing.
- Appropriateness of poles or pedestals for the site.
- Placement of signal standards to ensure legal placement of all vehicle and pedestrian signal indications.
- Placement of pedestrians pushbuttons relative to signal standards and in-place sidewalks and crosswalks.
- Detector placement and functions.
- Placement and type of junction boxes and conduit.
- Design of equipment pad.
- For revised systems, the wording of the notes on signal structure revision.

- Other items as noted in Publication 149 (refer to the various checklists in Pub 149).

**Number of Signal Faces**

Pub 149 discusses the number of signal faces for a traffic signal system. As such, there shall be a minimum of two vehicular signal faces on each approach. Refer to Pub 149 for additional details.

**Location of Signal Faces**

Pub 149 discusses the location of signal faces. Vehicular signal faces for an approach will preferably be located over the roadway. For traffic control signals on fixed supports, a minimum of one signal face shall be located over the roadway unless the approach speed limit is 25 mph or less.

For overhead signals, the signal face shall be a minimum of 40' from the stop bar and at least one face, preferably all faces, beyond the center of the intersection. The maximum distance is 150' before the need to have a supplemental signal face located as close as practical to the stop bar. The bottom of the housing of a vehicle signal face mounted or suspended over a roadway shall be at least 15 ft but not more than 19 ft above the pavement grade at the center of the roadway, but normally should be 16 ft. In addition, a minimum of two signal faces for through traffic should be continuously visible from a point at least the following distances (see [Exhibit 4-24](#)) in advance of the stop line, unless physical obstruction of their visibility cannot be avoided. Refer to Publication 149 and the MUTCD 2009 Edition for additional details.

**Exhibit 4-24 Minimum Visibility Distance in Advance of Stop Line**

85 <sup>th</sup> Percentile Speed, mph	Minimum Visibility Distance, ft
20	175
25	215
30	270
35	325
40	390
45	460
50	540
55	625
60	715

**Traffic Signal Clearance Intervals**

Refer to page [4-36](#) for the topic [Vehicle Change and Clearance Intervals](#).

**Emergency Traffic Signals**

An emergency-vehicle traffic control signal is a special traffic control signal that assigns the right-of-way to an authorized emergency vehicle. An emergency-vehicle traffic control signal may be installed at a location that does not meet other traffic signal warrants (see page [4-17](#) for Traffic Control Signal Warrants) such as at an intersection or other location to permit direct access from a building housing the emergency vehicle.

The emergency traffic signal shall meet the requirements of the 2009 MUTCD, which states:

“At least one of the two required signal faces for each approach on the major street should be located over the roadway.



The following size signal indications should be used for emergency-vehicle traffic control signals: 12-inch diameter for steady red and steady yellow circular signal indications and any arrow indications, and 8-inch diameter for green or flashing yellow circular signal indications.”

**Traffic Signals near Grade Crossings**

Part 8 of the 2009 MUTCD describes the traffic control devices that are used at highway-rail and highway-LRT grade crossings. Unless otherwise provided in the text or on a figure or table of the MUTCD, the provisions of Part 8 are applicable to both highway-rail and highway-LRT grade crossings. Refer to Part 8 of the MUTCD for additional details.

The Public Utility Commission (PUC) has jurisdiction over all highway-railroad crossings, whether crossing a highway at grade, above grade, or below grade. Therefore, the following policy shall apply when traffic signals are to be located within 300 feet of a railroad or transit highway grade crossing, as illustrated in Exhibit 4-25 or when railroad preemption is proposed:

**Exhibit 4-25 Required PUC Involvement**

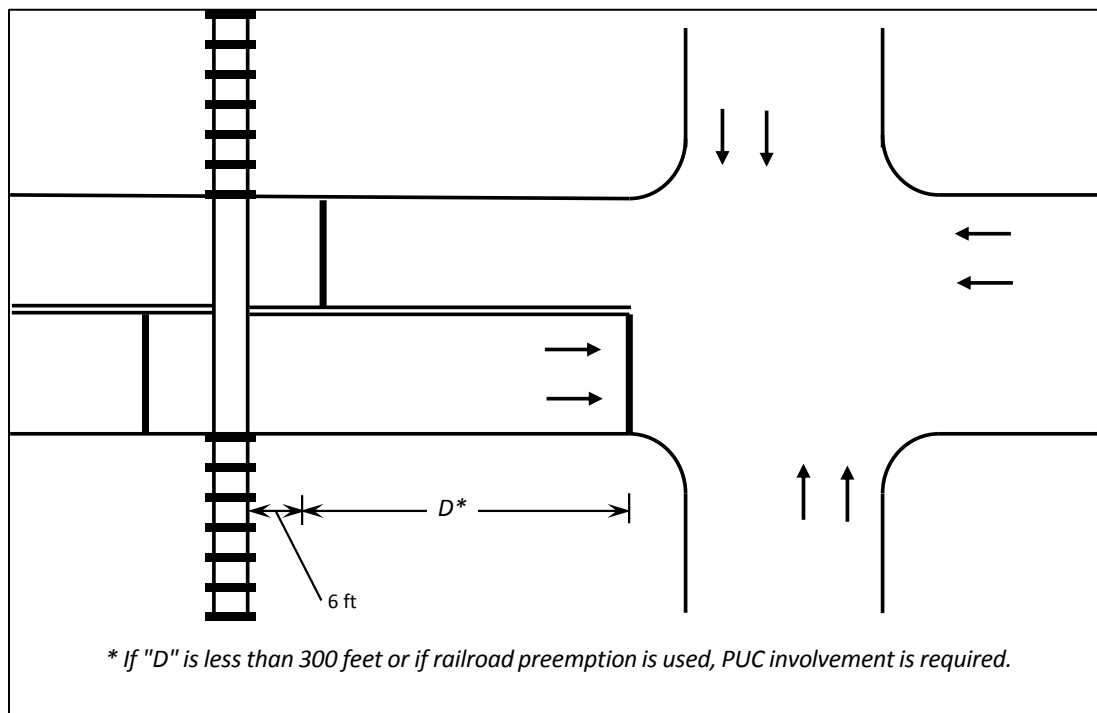

When PUC involvement is required, the following policy shall apply

- a) Construction Projects when Formal Application to PUC is Required.

The Department must make a formal application to the PUC if adjusting a railroad facility, or if the highway approaches to the crossing are to be altered, relocated, or a new crossing is to be constructed. When, as a part of such alterations, a traffic signal plan is included in the Department's construction contract, Districts must submit the information required in the following three basic stages:

Stage 1.

- Determine if a traffic signal is required and warranted. (See Warrant 9, “Intersection Near a Grade Crossing,” in Section 4C.10 of the MUTCD.)

- Obtain from the railroad or transit company involved, the information listed in Publication 149.
- Determine if the local officials will assume responsibility for the maintenance of the signal.
- Prepare a preliminary plan for the traffic signal and obtain BOMO's approval.
- Submit the plan to the railroad for their review and comment.

#### Stage 2.

- Obtain BOMO approval of the final traffic signal plans.
- Traffic signal agreements executed by the local officials and approved by the Department or a letter of intent from the local officials shall be a part of the plans for the PUC. Districts shall submit this information to the Chief Utility Engineer in the Bureau of Project Delivery for their submission to the PUC, except when the District Grade Crossing Engineer is authorized to make submissions directly to the PUC.
- The District Traffic Unit should attend the field investigation and conference.

#### Stage 3.

- After the field investigation and conference, all comments pertaining to the traffic signal plan shall be resolved and a final plan prepared and approved by BOMO, and afterwards made a part of the Department's construction plan.
- The District should obtain railroad approval in writing prior to the PUC hearing. As a result of the hearing, the traffic signal plan will then be entered as a Department exhibit.
- The PUC will grant final approval of the traffic signal as part of the PUC Order.

#### b) Traffic Signal Installations Required by PUC Complaint or Investigation Docket.

In cases where the PUC under a Complaint or Investigation Docket orders the Department to prepare a study or proposal for the installation of traffic signals near grade crossings, the District will develop the necessary plans and obtain BOMO concurrence. Upon receipt of concurrence, Districts shall forward the recommendations to the Chief Utility Engineer in the Bureau of Project Delivery for their submission to the PUC, except when the District Grade Crossing Engineer is authorized to make submissions directly to the PUC.

#### c) PennDOT Construction when Formal Application to PUC is not Required.

The District should follow the above Stage 1 procedures in all other instances when existing or proposed traffic signals are included in the Department's construction contract.

However, when the final plan is accepted by BOMO and a traffic signal agreement has been executed by the local officials or a letter of intent has been received, the District, if authorized, will submit the traffic signal plan to the PUC for approval.

Upon receipt of PUC approval, the District will include the traffic signal plan in the Department's construction plan.

#### d) New Request or Revision – Construction if required is by others.

New requests or revisions to traffic signals, requested by the local officials or developed by the District, will follow the procedure set forth in “(c)” above, except that upon receipt of PUC approval, a permit will be issued to the local officials by the District Executive.

Since the traffic signals are to be a part of the Department's construction project in “(a)” and “(c)” above, the District shall issue a permit with a copy of the plan sheet to the local officials after the construction project is let and awarded. A final as-built plan with wiring diagrams for the controller, accessory equipment, detectors, signal heads, and interconnecting equipment should also be furnished to the local officials upon finalization of the installation.

## Traffic Signal Plans

### General

Preliminary and final signal plans for construction projects should conform to the Traffic Signal Design Handbook ([Publication 149](#)). As such, the plan should include the following elements:

- Construction baseline.
- Roadways, shoulders curbs, curb ramps, sidewalks islands, inlets, and all utilities.
- Pavement markings.
- Signal supports, controller, junction boxes, signal heads, detectors, pedestrian accommodations, and luminaires.
- Movement, phasing, and sequence chart, including preemption and emergency flashing operation
- Electrical distribution.
- Structure sizes, location, offsets, and orientation relative to the construction baseline.
- Tabulation of quantities.

Traffic signal phasing should conform to [Publication 149](#), and use NEMA numbering protocol. The goal is to use the minimum number of phases possible in order to reduce the accumulative amount of clearance time and thereby improve efficiency. If an exclusive pedestrian phase is used, it may be labeled Phase 9.

Yellow and all-red clearance intervals shall conform to [Publication 149](#), respectively and to the topic [Vehicle Change and Clearance Intervals](#) on page [4-36](#).

It is important that the location of signal supports conform to [Publication 149](#). Specifically, supports for overhead signals and base-mounted controller cabinets shall not be breakaway. However, these supports and other rigidly-supported appurtenances should be located as far as practical beyond the edge of the traveled roadway and outside the pedestrian accessible route. The minimum clearance of any part of the signal equipment and the supports in areas with curbs and speeds of 35 mph or less shall be 2 feet behind the face of the curb. In all other locations, the minimum clearance shall be 10 feet from the edge of the traveled roadway and a minimum of 2 feet from the outer edge of any shoulder. If possible, do not place supports on an island.

### Traffic Signal Construction Plans

The end product of the pre-construction activities in signal design is the Traffic Signal Construction Plans. Supporting the plans and Special Provisions are the standard design practices, standard details, other

---

applicable national and local standards, and any necessary agreements. Typical information found in a Traffic Signal Plan sheet includes the following:

1. Sign Tabulation
2. Movement, Phasing and Sequence Chart
3. Phasing Diagram
4. Signal Identification
5. Legend
6. Title Block
7. Notes
8. Signal Wiring Diagram
9. Upper Title Block
10. Intersection Layout (for Construction Plans include the following)
  - Existing data as per PennDOT Publication 13M (Design Manual 2)
  - New curbs
  - Pavement markings (only those to be installed by contractor)
  - Supports with pole #'s
  - Signals with #'s
  - Pedestrian signals and pushbuttons with #'s
  - Controller
  - Detectors with #'s
  - Signs with letter designation (only those to be installed by contractor)
  - Junction boxes with #'s
  - Conduit
  - Service location and type
11. Traffic Signal Supports
12. Electrical and Conduit Items
13. Detectors
14. Miscellaneous

### **Traffic Signal Permit Plans**

The Permit Plan includes the items listed above in the section on Traffic Signal Construction Plans. The Permit Plan also should include a permit block in the Upper Title Block. The Intersection Layout should also include the following for the Permit Plan:

- New curbs
- Pavement markings

- Supports
- Signals with #'s
- Pedestrian signals and pushbuttons with #'s
- Controller
- Detectors with dimensions
- Signs with letter designation

### **Traffic Signal Tab Sheets and Presentation**

Chapter 2 of Design Manual 3 provides guidance for the orderly preparation of final Construction Plans. The methods, procedures and examples presented within the Design Manual are to be followed to promote consistency in the preparation of Construction Plans.

### **Pedestrian Accommodations**

Pedestrian amenities include: pedestrian indications, pedestrian push buttons, pedestrian pavement markings (crosswalks), pedestrian ramps, sidewalk, and type R signs, Accessible Pedestrian Signal (APS).

Engineering judgment should determine the need for separate pedestrian signal heads and accessible pedestrian signals. The following considerations should be considered:

#### **Preliminary Considerations**

- What are the concerns of the local municipality and/or road authority? Are these concerns political or engineering related? Do these concerns have merit?
- Are there any documented pedestrian concerns for the area and/or particular intersection? Review if available.
- What is the current zoning for undeveloped property? Is development imminent? Is the zoning likely to change?
- Is the area residential, urban or rural in development?
- Are there pedestrian generators in the area?
- What pedestrian movements are provided at near signals?
- What are the in-place or planned bus routes/light rail/ bike paths/sidewalk?
- What warrants are applicable to the signal? (school/pedestrian volumes)
- Is the age of likely pedestrians an issue? (schools/retirement complexes)

#### **Roadway Geometric Considerations**

- What median is in-place or shall be constructed for system? Is the median width appropriate for pedestrian haven?
- Are there geometric limitations to the system that restrict pedestrian movements? (i.e. adjacent bridge without pedestrian provisions, adjacent retaining walls/ physical constraints, etc.).
- With what type of roadway geometrics will the system operate? (4 legs, T-intersection, etc.).

**Preparatory Work for Specific Design Situation**

- Review accident studies.
- Review available pedestrian counts. If not available, is it appropriate/feasible to obtain accurate pedestrian counts?
- Perform a field review. What are the in-place pedestrian crossings and amenities? Is it appropriate to propagate all the in-place crossings?
- Are there any known safety issues such as pedestrian paths or visibility?
- Perform a field view to find any evidence of pedestrian activity, such as the presence of a footpath.

**General Operational Considerations**

- Are pedestrians being prohibited inappropriately?
- Is a single crossing over the trunk highway mainline appropriate?
- Are standard operational considerations appropriate? (i.e. 3.5 feet per second rate, coordination, pedestrian recall).

**Pedestrian Amenities for Signal System**

- What can be accomplished? Is the signal work a revision/rebuild (existing pedestrian patterns?)/new signal?
- Are push buttons in the median feasible – geometric, maintenance and operational (winter and safe haven) concerns? If placed within the median, on which side or sides should the push buttons be placed?
- Are pedestrian ramps and sidewalk in-place within the median and in appropriate locations? If not in conformance or not in-place, should ramps and/or sidewalk be placed?
- Are pedestrian ramps and pavement markings in-place? Are in-place ramps and markings in conformance with the Uniform Federal Accessibility Standards (UFAS)? Are plow friendly corners needed?
- Is sidewalk in-place? Does in-place sidewalk coincide with pedestrian ramps and movements? Is new or additional sidewalk necessary?
- For identified pedestrian crossings, are both indications (international) and push buttons appropriate or are combinations of the items appropriate?
- If pedestrian indications and/or push buttons are not provided at specific crossings, it may be appropriate to include spare wires for possible future use.

**Turn Lane Warrants and Length Determination**

Turn lane warrants and length determination are found in Chapter 11. Refer to the section [11.16 Turn Lane Guidelines](#) on page 45. Turn lane Warrants are found on page 46 and Turn Lane Storage Length is found on page 46.

**Type of Operation and Phasing**

Publication 149 includes information on Traffic Signal Phasing and Traffic Signal Timing. In addition, the following information is included in the discussion.

**Traffic Signal Phasing**

A traffic signal phase, or split, is the part of the cycle given to an individual movement, or combination of non-conflicting movements during one or more intervals.

**Phase Numbers**

Phase numbers are the labels assigned to the individual movements around the intersection. For an eight phase dual ring controller, it is common to assign the main street through movements as phases 2 and 6. Also, it is common to use odd numbers for left turn signals and the even numbers for through signals. A rule of thumb is that the sum of the through movement and the adjacent left turn is equal to seven or eleven.

Exhibit 4-26 shows a typical phase numbering scheme for an east/west arterial and a north/south arterial.

**Exhibit 4-26 Traffic Signal Phase Numbers**

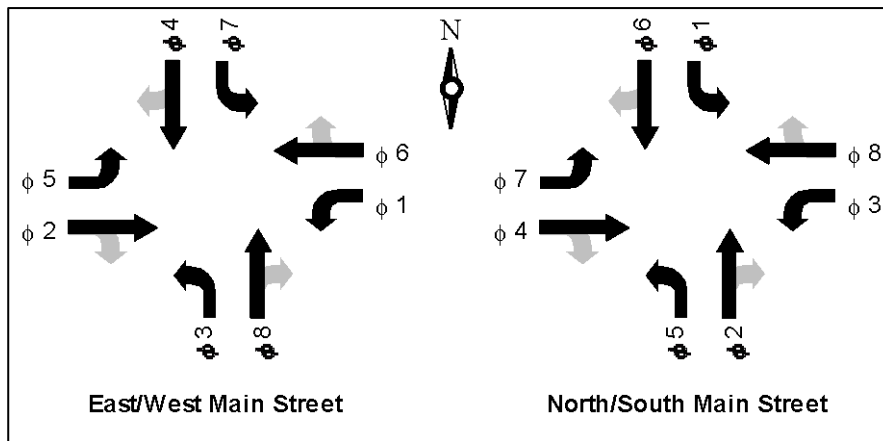

**Ring**

A ring is a term that is used to describe a series of conflicting phases that occur in an established order. A good understanding of the ring structure is a good way to understand the operation of multiphase controllers.

**Barrier**

A barrier (compatibility line) is a reference point in the preferred sequence of a dual-ring controller unit at which all rings are interlocked. Barriers assure there will be no concurrent selection and timing of conflicting phases for traffic movements in different rings. All rings cross the barrier simultaneously to select and time phases on the other side.

**Dual Ring Control**

The traffic actuated controller usually employs a “dual ring concurrent” timing process. The NEMA concept is illustrated in Exhibit 4-27.

Exhibit 4-27 NEMA Dual Ring Structure

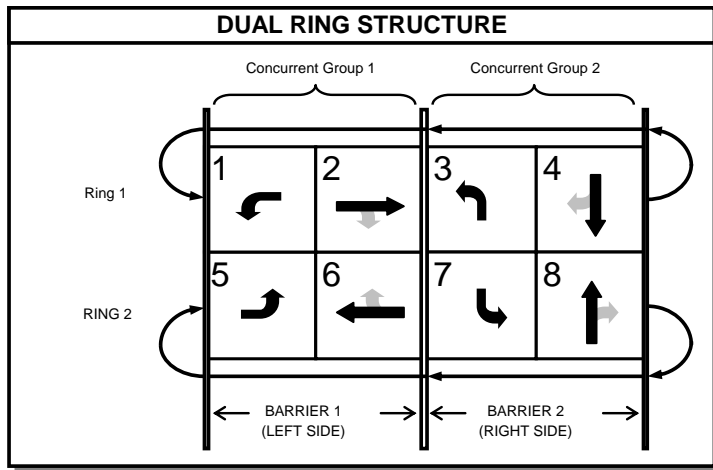

Typically, eight phase modules are used on a dual ring controller, each of which controls a single traffic signal face with red, yellow and green display. The eight phases are required to accommodate the eight movements (four through and four left turns) at the intersection. Phases 1 through 4 are included in ring 1, and phases 5 through 8 are included in ring 2. The two rings operate independently, except that their control must cross the “barrier” at the same time. Phases 1, 2, 5 and 6 are defined as Concurrent Group 1. Phases 3,4,7 and 8 are defined as Concurrent Group 2.

If the movements to be controlled by these eight phases are assigned properly, the controller will operate without giving the right-of-way simultaneously to conflicting movements. All of the movements from one street (usually the major street) must be assigned to the left side of the barrier. Similarly, all movements from the other street must be assigned to the right side.

Within each Concurrent Group, phases may operate simultaneously vertically (in the ring chart) or may advance diagonally. All Phases in a Concurrent Group must terminate before crossing the barrier into another Concurrent Group.

**Flashing Operation**

**General**

Unless an engineering and traffic study indicates otherwise, traffic control signals may be flashed during periods of low traffic volumes. Flashing operation may be considered if the total volume of vehicles entering the intersection drops below 325 vehicles per hour in urban areas or 225 vehicles per hour in rural areas for a period of four or more consecutive hours.

Some factors which may preclude instituting programmed flashing operation during periods of low volume include inadequate sight distance, an increase in the number or severity of crashes, an observed increase in vehicular conflicts, undesirable increases in traffic speeds, or actuated operation.

**Meaning**

**Flashing Red:** When a red lens is illuminated with rapid intermittent flashes, drivers of vehicles shall stop in the same manner as at a stop sign, and the right to proceed shall be subject to the rules applicable after making a stop at a stop sign.

**Flashing Yellow:** When a yellow lens is illuminated with rapid intermittent flashes, drivers of vehicles may proceed through the intersection or past such signal only with caution.



**Application**

When a traffic control signal is put on flashing operation, normally yellow indications should be used for the major street and red indications for the other approaches. Yellow indications shall not be used for all approaches. The following shall apply whenever signals are placed in flashing operation:

- a) A circular yellow shall be flashed instead of any yellow arrow which may be included in that signal face.
- b) No steady circular green or green arrow or flashing yellow shall be terminated and immediately followed by a steady red or flashing red without the display of the steady yellow indication; however, transition may be made directly from a steady circular green or green arrow to a flashing yellow.
- c) Stop signs should not be used with traffic control signals during normal flashing operations.

**Operation**

Flashing shall be continuously at a rate of not less than 50 nor more than 60 times per minute. The illuminated period of each flash shall be not less than half and not more than two-thirds of the total flash cycle.

Changes from flashing to stop-and-go operation shall be made at the beginning of the major street green interval, preferably at the beginning of the common major street green interval (i.e., when a green indication is shown in both directions on the major street). Programmed changes from stop-and-go to flashing operation shall be made at the end of the common major street red interval (i.e., when a red indication is shown in both directions on the major street).

Where there is no common major street green interval, the change from flashing to stop-and-go operation shall be made at the beginning of the green interval for the major traffic movement on the major street. It may be necessary to provide a short, steady all-red interval for the other approaches before changing from flashing yellow or flashing red to green on the major approach.

**Traffic Signal Wiring Diagram**

To aid in the construction and maintenance of signal wiring, a schematic signal wiring diagram is created and shall be prepared for each traffic signalization design location. This diagram shall show the controller, signal heads, detectors, and pushbuttons as well as the required number, size, and types of wiring, and splices. An example of a wiring diagram is shown in Publication 149.

Prior to the creation of the wiring diagram, the following must be prepared and completed:

- a) Traffic signal layout with all signal heads numbered;
- b) Traffic signal operation chart; and
- c) Conduit and junction box layout.

The following rules shall be adhered to when determining the required wiring:

- a) Phase neutrals shall not be mixed;
- b) Only those signals that display identical indications throughout the sequence of operations may have their wires terminated together.

### Design Criteria for Traffic Signal Structural Supports

Vertical poles and mast arms shall be designed and constructed in accordance with the 2001 AASHTO "Standard Specifications for Structural Supports for Highway Signs, Luminaires and Traffic Signals" including interim specifications (2002, 2003, and 2006). Publication 149 includes details on the design of traffic signal supports and covers the Design Criteria for All Support Structures.

Publication 148, Traffic Standards -- Signals, TC-8801 Series graphically illustrates the design and construction details for traffic signal structural supports. This includes the following seven (7) Traffic Signal Support standards:

- Mast Arm
- Strain Pole
- Foundation Notes and Anchor Bolt Details
- Foundation Type A
- Foundation Type B
- Brackets
- Miscellaneous Details

### Detection

Many types of detection systems exist, most available as a means of detecting vehicles. The detection of pedestrians typically used by the Department is push button technology only.

Publication 149 (Traffic Signal Design Handbook) provides key guidance when selecting the proper detection system at an intersection. To ensure maximum effectiveness of each device it is recommended where possible, that manufacturer's recommendations are followed.

Detection systems should be inspected routinely using the guidance materials provided in the TE-972 and TE-973 Forms (see Appendices F and G). These documents will provide the necessary details to consider when providing both response and preventative maintenance. The Traffic Signal Permit, Publication 408 (i.e., "Highway Specifications") and Publication 149 (i.e., "Traffic Signal Design Handbook") are key materials that should be used when evaluating detection systems.

### Vehicle Detection

Detection is critical to an intersection's safe and efficient operation. When a traffic signal is properly timed with detection fully functional, its operation is generally efficient. If an intersection lacks detection, unnecessary delay will occur resulting in wasted fuel and increased emissions. An example of a common occurrence with malfunctioning detection is a failed loop detector for a left-turn lane. Upon failure the signal controller is sent a signal to call the left-turn phase each cycle. This occurs whether vehicles are present or not, holding opposing traffic at a red indication. This again results in increased emissions and delays.

The different types of vehicle detectors available include but are not limited to the following types:

- **Inductive loop** detects a change in resonant frequency by the introduction of a ferrous metal in the magnetic field of the detection zone.
- **Video** detects a change in a video pixel range – presence or pulse.

- **Magnetic/Magnetometer** detects moving ferrous metal objects – pulse.
- **Photo electric/Infrared** detects a break in a beam of light – presence or pulse.
- **Radar/Microwave** detects moving objects by sending and receiving electronic pulses – pulse.
- **Ultrasonic** detects sound with a microphone – presence or pulse.
- **Micro-loop** detects a change by moving ferrous metal in the earth’s magnetic field – pulse.

More details on detection can be found in Publication 149.

**Preemption and Priority Control Detection Systems**

**Emergency Vehicle Preemption (EVP)**

Systems in which traffic control signals are preempted by approaching emergency vehicles shall be designed and installed to provide an indication (fail-safe) to the driver of the approaching emergency vehicle when the equipment has preempted the traffic signal at that intersection. The fail-safe indication shall be a flashing white light on the street or approach on which the emergency vehicle is approaching.

Traffic signals operating during preemption conditions should be operated in a manner designed to keep traffic moving. The stopping of all traffic by the display of a steady all-red is prohibited, except during normal clearance intervals.

The Department will permit the purchase of devices on the mast arms (or span wires) for State or Federal funded projects if requested. Emitters would be up to the municipal traffic signal owner.

**Emergency Vehicle Preemption Operation**

Emergency vehicle preemption may occur during any interval of the normal controller operation. Depending upon the direction of travel of the emergency vehicle, one of the following phases (using NEMA phases) will be displayed: Phase 1+6, 2+5, 3+8, or 4+7.

The system shall provide service on a first-come, first-serve basis. Once the first priority vehicle calls the system, it shall prevent other preemptive vehicles from entering calls until the first emergency vehicle releases control and clears the intersection.

The transition into and out of preemption as a result of a preemptive call being received during any interval of traffic signal operation shall be clearly defined in the Movement, Phasing, and Sequence Chart; Phasing Diagram; and associated notes on the traffic signal permit.

Upon termination of the preemption phase, the controller goes to the pre-designated post preemption phase, then to normal “Phase Next” operation. The preemption phase and the post preemption phase may be as follows:

Preemption Phase	Post Preemption Phase*
1+6	2+6
2+5	2+6
3+8	4+8
4+7	4+8

\* The Post Preemption Phase should typically be Phase 2+6 (Main St). Only in rare exceptions it could be 4+8 (ramp back or the like)

As an alternative, the post preemption phase would be the major street green. For additional details, refer to Publication 149.

## Traffic Signal Systems

### System Concept

A system may be defined as an arrangement or combination of interacting or interdependent parts which form a unified whole serving a common purpose. The system concept as related to traffic signal control includes the methods, equipment, and techniques required to coordinate traffic flow along an arterial or throughout an area.

### System Objective

The major objective of a traffic control system is to permit continuous movement and/or minimize delay along an arterial or throughout a network of major streets. This involves the selection, implementation, and monitoring of the most appropriate operational plan. Basically, a traffic signal system provides the appropriate and necessary timing plans for each intersection in terms of individual needs as well as the combined needs of a series of intersections.

### Relationship of Timing Plans to Traffic Control

In the system concept a timing plan is defined by a combination of control parameters for one or more intersections based upon an analysis of demand. Timing plans can be provided as a function of equipment at the local intersection, the central control point, or both. Timing plans consist of:

1. **A system Cycle.** A specific cycle length is imposed throughout the system covered by the timing plan.
2. **Split.** All intersections in the system have defined splits which are the apportionment of the cycle to the various phases present at that intersection.
3. **Offset.** Each intersection has a unique offset. The offset is the relationship of the beginning of the main street green at this intersection to a master system base time. Offsets are generally expressed in seconds. Properly established offsets along a street can potentially provide for smooth traffic flow without stopping.

### Basis of Selecting Timing Plans

The selection parameters which define timing plans include:

1. Historic Data Time of Day information compiled from traffic counts to reflect traffic volumes for specified time of day (morning peak, midday, afternoon peak, etc.) and day of week.
2. Current Data Real time on-street volumes from traffic detection equipment.
3. Special Data Special events, emergency route assignment, special right-of-way preemption (fire equipment, ambulances, buses, etc.)

### Types of Traffic Signal Control Systems

Many combinations of methods, equipment, and techniques can comprise a traffic signal control system. Generally, these systems fall into the following basic types.

#### Time Based Coordinated (TBC) System

This form of coordination utilizes non-interconnected controllers with auxiliary devices called time based coordinators. These devices use the power company supplied frequency to keep time very accurately. Various timing plans can be established with time of day and day of week plan changes. Since all intersections use the same power source, the time-based coordinators provide coordination without physical interconnection.

Global Positioning System (GPS) receivers have been used for several years to provide a clock sync to ensure TBC is maintained.

### **Interconnected Pre-timed System**

This type of system was originally developed for electromechanical controllers, but can also be used with some of the newer controllers. Local intersections are physically interconnected (usually by a 7-wire cable) to ensure coordinated operation. The system provides automatic re-synchronization should a signal go “out of step”. The number of timing plans is a function of the number of dials and the number of offsets and splits per dial; the most common system consists of a three-dial, three-offset, one-split combination. Timing plans are normally selected by a time clock or time dependent programming device. The local controller for one intersection may act as master controller for the system.

### **Traffic Responsive System**

Basically, this is an interconnected system utilizing a master controller for pattern (Cycle/offset/splits) selection. Traffic detectors are used to sample directional volumes and detector occupancy. Volume and occupancy metrics determine which of the available patterns is selected (i.e., inbound, outbound, or average) based on predetermined thresholds. The master controller may be an analog or a digital computer.

### **Interconnected Actuated Systems**

Generally a small system with a master-local relationship (i.e., two or more fully-or semi-actuated local controllers with one acting as system master and controlling cycle length for the other controllers). A variation of this system uses a system master, coordinating units, and local actuated controllers. The master may be traffic responsive or combination of time clocks.

### **Closed Loop System**

In this system, second-by-second commands are transmitted from local masters to the intersection controllers. The masters communicate with the central processor only when failure occurs, or when commanded to do so by the central processor. The connection between the masters and local controllers is usually made via communication cable (or other means of interconnect). The connection between the masters and the central computer is often made via dial-up telephone. In this way, it is possible to minimize the cost between remote groups of intersections and a central site. For this reason, closed-loop systems are popular with State and county agencies responsible for control of intersections dispersed over a wide geographic area.

### **Traffic Adaptive System**

Traffic adaptive systems perform “real-time” adjustments to the cycle length, splits and offsets in response to traffic demand. Traffic adaptive systems require extensive detection inputs. Complete and accurate traffic flow data must be gathered, processed and communicated to the central computer.

### **Advanced Traffic Management Systems (ATMS)**

ATMS are capable of monitoring and controlling thousands of intersection controllers using state of the art architecture like TCP/IP and NTCIP. ATMS offer complete traffic and data management including real time field reporting for multiple users over distributed local and wide area networks and remote access.

ATMS offer scalable software solutions that support a range of users including:

- School zone flashers
- Freeway management

- CMS, VMS, DMS
- CCTV surveillance
- HOV lane control
- Reversible lane control signals
- Real-time split monitoring and time space reporting
- Incident detection
- Light rail control systems
- Transit priority systems
- 1.5 generation timing plan development using Synchro or PASSER
- 2.0 Generation control (Traffic Responsive and Traffic Adaptive)
- Integrated video detection
- Real time preemption log retrieval

**Traffic Signal Signs and Pavement Markings**

Refer to Publication 149, 111 and 236 for details on Traffic Signal Signs and Pavement Marking.

**Temporary Traffic Signal Design in Workzones**

Temporary traffic control signals have historically been installed on span wire and only for long-term construction projects. However, with the advent of the portable traffic signals, these pedestal-mounted or trailer-mounted devices can now be used for both temporary short-term and long-term maintenance and construction projects.

**Exhibit 4-28 Portable Traffic Control Signals**



Pedestal-Mounted and Trailer-Mounted Portable Traffic Control Signals

Courtesy of Horizon Signal Technologies

Temporary and portable traffic control signals may be used to control one-lane, two-way traffic and they may also be used for other special applications such as a highway or street intersections with a temporary haul road or equipment crossing.

The design and application of portable traffic control signals must conform with the applicable requirements of the Department's certificate of approval issued to the manufacturer for portable traffic control signals, and to any special requirements defined in the Temporary Traffic Control (TTC) Plan.

The [Publication 213](#) (i.e., Temporary Traffic Control Guidelines) provides traffic control figures and related information in Appendix A as identified in Exhibit 4.5-C. Exhibit 4.5-C.

**Exhibit 4-29 Reference Guide for PATA 26e**

Reference Guide for PATA 26e Typical Traffic Control Signal Figures For Two-Lane, Two-Way Highway with One-Lane, Two-Way Traffic			
Condition	Figure Number in Publication 213		
	Using Fixed Supports	Using Pedestal-Mounted Portable Traffic Control Signals	Using Trailer-Mounted Portable Traffic Control Signals
Short-Term Stationary Operation Manually-Controlled		PATA 26e M-1	PATA 26e M-2
Short-Term Stationary Operation For Non-Complex Conditions		PATA 26e NC-1	PATA 26e NC-2
Short-Term Stationary Operation For Complex Conditions		PATA 26e C-1	PATA 26e C-2
Long-Term Stationary Operation	PATA 26e PL		PATA 26e PL

Publication 213 Appendix A also includes the following documents for temporary traffic control signals

- Temporary traffic control signal requirements and timeframes
- Process for obtaining PennDOT approval to use temporary traffic control signals
- Blanket permits
- Application for permit to operate temporary traffic control signals
- Temporary traffic control signal permit
- Application instructions for permit to operate temporary traffic control signals
- Example problem: application for permit to operate temporary traffic control signals
- Guidelines for the selection of temporary traffic control signals in work zones
- Temporary traffic control signals non-compliance documentation form
- Temporary traffic control signals user comment form

**Positive Offset for Opposing Left-Turn Lanes**

Whenever possible, it is desirable to design opposing left-turn lanes to provide positive offset to minimize the obstruction of sight distance. To accomplish this, align the left edge of both left-turn lanes to the left of the right edge of the opposing left-turn lane as illustrated in [Exhibit 4-30](#). A minimum 3-foot positive offset will usually eliminate the sight-distance problem cause by a vehicle in the opposing left-turn lane.

On undivided highways, this positive offset can sometimes be provided by the use of solid channelizing lines in accordance with the following figure from the FHWA [Travel Better, Travel Longer: A Pocket Guide to Improve Traffic Control and Mobility for Our Older Population](#).

**Exhibit 4-30 Positive Offset for Left-Turn Lanes**

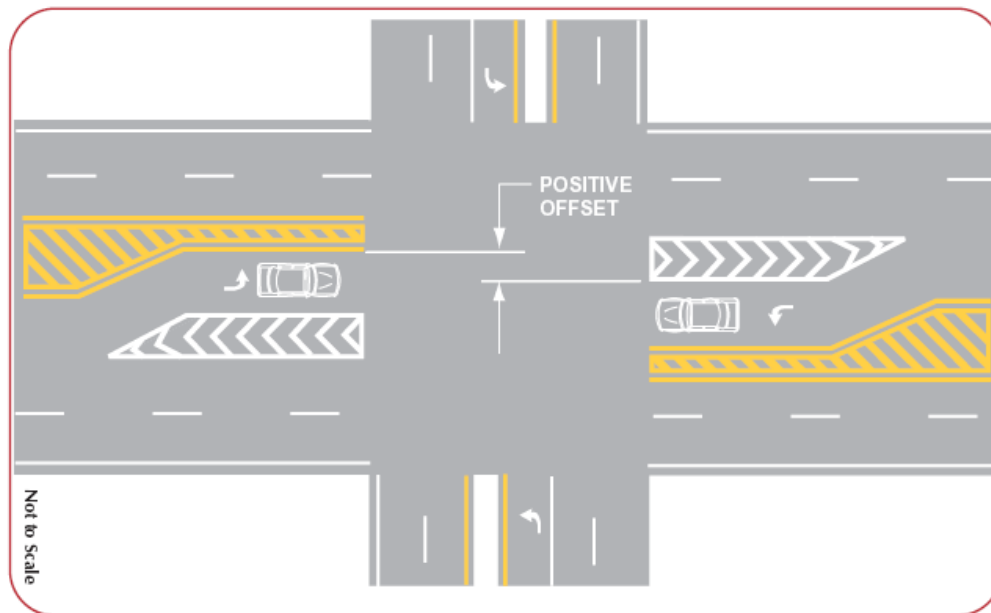

**Left-Turn Signal Phasing**

In addition to the left-turn signal phasing criteria in Publication 149, consider the following information and sound engineering judgment in future studies to determine the type of traffic signal phasing for left-turn movements at intersections.

Please note that in Publication 149, the conflict factor and the minimum approach volume of two left turns for each existing cycle during two or more 1-hour periods of a normal weekday are not the only criteria when determining whether a left-turn phase is required. Rather, the conflict factor and the left-turn volume are a guide and a good starting point to evaluate the use of left-turn phasing. As indicated in Publication 149, a left-turn signal phase may be considered if either the volume criteria (conflict factor/minimum left-turn volume) or other geometric and operational characteristics satisfy the various criteria.

Other criteria that should be considered when determining if a left-turn signal phase is appropriate are as follows:

- A minimum of five correctable reported crashes have occurred within a continuous 12-month period over the last 3 years. This criterion allows the consideration of both correctable, non-reportable crashes and correctable, reportable crashes over the most recent 3-year period. Non-



reportable crashes must be police-verified and documented to enable consideration (i.e., a police crash report is available).

- If a left-turn phase will reduce delay and improve the overall level of service.
- When drivers are having difficulties making left turns and the municipality desires a left-turn phase, perform a capacity analysis to determine if a left-turn phase would increase delay. Whenever possible, the municipality and the Department should reach consensus on the incorporation of a left-turn phase based upon safety concerns and the level of increased delay. In general, avoid a solution that lowers an intersection into Level of Service E.
- Signalized intersections with left turn lanes (either new installations or in conjunction with a major permit change) should be analyzed to determine if a left turn phase would be beneficial to safety and traffic flow.
- A signalized intersection without a left-turn phase may have less turning traffic than adjoining or nearby signalized intersections with left-turn phases. A portion of the driving public may migrate to an intersection with a left-turn phase for safety and security reasons (i.e., they may find it easier to make the turn there). Therefore, installing a left-turn phase may increase the turning traffic at that intersection and reduce left-turn traffic at adjoining or nearby signalized intersections with existing left-turn phases.

In addition to considering the geometric and operational characteristics already mentioned in Publication 149 and some of the factors mentioned above, consider a protected/prohibited left-turn phase if any of the following conditions exist:

- Dual left-turn lanes.
- Three or more opposing through lanes.
- Multi-legged intersections with more than four approaches.
- Approaches that have experienced five or more crashes (including non-reportable) of a type that would be susceptible to correction by the protected/prohibited phasing within a continuous 12-month period over the most recent 3 years. (Non-reportable crashes must be police-verified and documented to enable consideration.)
- Approaches with significant non-correctable, sight distance deficiencies, including deficiencies created by stopped opposing left-turn vehicles.

Before implementing a protected/prohibited left-turn phase, examine the left-turn lane storage length to determine if adjustments are necessary.

This information applies to new traffic signal installations. However, if there is a known safety problem or a major permit change (such as pole replacements) at existing signals with protected/permitted left-turn phasing; review the above conditions for possible protected/prohibited phasing. Consider changes in signal phasing at such sites if there is a documented problem involving reportable and non-reportable crashes attributed to the protected/permitted left-turn phasing.

### **White Strobe Lights within or adjacent to Red Traffic Signal Indications**

In the past, the Department has allowed some municipalities to install white strobe lights within or adjacent to red traffic signal indications, that would flash whenever the signal was red (see [Exhibit 4-31](#)). The intent was to “wake up” inattentive drivers and thereby improve safety, but research has indicated that these strobe lights are not beneficial. Therefore, in compliance with Section 4D.06 of the MUTCD, the Department

will not allow any new strobes to be installed within or adjacent to any red signal indications. Further, if an Engineering District is aware of any active strobe lights, they shall contact the local officials and advise them that these strobes need to be removed.

**Exhibit 4-31 Traffic Signal White Strobe Lights**



**Overhead Street Name Signs**

Street name signs are invaluable to unfamiliar drivers, and overhead street name (OSN) signs that are near traffic signals are especially valuable because drivers should already be looking in that general area. Therefore, when roads have generally accepted street names as determined by the local authorities, OSN signs (D3-4 and D3-5) are required at all new signalized intersections. The additional wind loading created by installing a D3-4/D3-5 sign to an existing mast arm support does necessitate a structural review.

The addition of OSN signs at existing traffic signals is encouraged when revising the traffic signal permit whenever a bucket truck will be required at the intersection to make other physical changes to the signals.

The minimum mounting height to the bottom of the sign is 17 feet. When attached to traffic signal mast arms, OSN signs should generally be centered vertically at the same height as the mast arm, except when OSN signs are installed on existing mast arms the signs may be designed to rotate and spill the wind in an effort to reduce the wind loading. The preferred horizontal location is to the right of the right overhead signal, approximately centered over the right edge of the right approach lane (refer to Publication 149).

**Exhibit 4-32 Overhead Street Name Signs**



As noted on the D3-4 and D3-5 sign standards, the preferred color of OSN signs is white on green, Engineering Districts may authorize white-on-blue, white-on-brown, or black-on-white colors when requested by the local authorities.

The D3-4 and D3-5 sign standards depict the use of upper and lower case legend. All new OSN signs within Pennsylvania should use Clearview legend in accordance with the sign standards.

In an attempt to maximize legibility, do not use left or right arrows on the D3-4 sign unless the sign is used at crossroad where one of the legs is not a public road. Also, avoid using suffixes such as “Rd” and “St” on OSN signs except as follows:

- For alphabetic or numeric street names (e.g., K St and 13<sup>th</sup> St).
- To distinguish between other nearby roads with the same base name (e.g., Schuylkill Dr and Schuylkill Ave), or
- When the name of the roadway is a cardinal direction (e.g., East Ave and North St), or anytime that the lack of the suffixes could be confusing.

**Advance Street Name Signs**

Advance Street Name Signs (D3-2) are desirable especially on multilane approaches where the driver might be required to make multiple lane changes. These are discussed in detail in Chapter 2, see pages 2-22 and 2-32.

**Exhibit 4-33 Advance Street Name Sign**



**Lane Control Signs**

Lane Control Signs (R3-5, R3-6, R3-7 and R3-8 series) should be installed as applicable. When through lanes become mandatory turn lanes, or when more than one lane is allowed to turn, Engineering Districts should require overhead lane control signs in advance of the traffic signal since driver expectancies are being violated.

If the road user needs to be in an appropriate lane in advance of an intersection to make a movement at the intersection, signage is needed to convey this message to the user. [Exhibit 4-34](#) provides an example of overhead signs used to assist drivers in selecting the proper lane on approach to a signalized intersection.

#### **Exhibit 4-34 Lane Control Signs**



#### **Internally Illuminated Street Name Signs**

Illuminated signs may be used where an engineering study shows that reflectorized signs will not provide effective performance or where extraneous light makes it difficult to read reflectorized signs.

The traffic control signal shall be given dominant position and brightness to assure its target priority in the overall display.

Internally Illuminated signs are referenced in Publication 408, section 950.2 and a picture is shown in [Exhibit 4-35](#).

#### **Exhibit 4-35 Internally Illuminated Street Name Sign**



#### **Other Traffic Signal Design Criteria**

- Intersection Control Beacons, refer to page [4-21](#)
- Flashing Warning Devices, refer to page [4-23](#)
- School Warning Devices and Speed Limit Systems, refer to page [4-30](#)
- Rectangular Rapid Flashing Beacons, refer to page [4-32](#)
- In-Roadway Lights, refer to page [4-31](#)

### **4.7 Equipment**

In this section, the following items are discussed:

- Traffic Signal Structural Supports
- PennDOT's position on purchasing preemption devices

- Use of Accessory Equipment
- Requests for Change of Signal Equipment
- Proprietary Approval

## General

### Approval Requirements and Process

All traffic signal equipment needs to be Department approved. All PennDOT approved products listings are located in PennDOT Publication 35 (Bulletin 15). Traffic Signal Structural Supports (Section 1104.03).

In addition, Pa. 67 § 212 states:

*“Statutory requirements. Under 75 Pa.C.S. § 6127 (relating to dealing in nonconforming traffic-control devices), it is unlawful for a person to manufacture, sell, offer for sale or lease for use on the highway, any traffic-control device unless it has been approved and is in accordance with this title.”*

### Use of Auxiliary Equipment

The use of Auxiliary devices and systems must be approved by the Department per 67 Pa. Code § 212.8.

### Traffic Signal Structural Support Approval

This information in this section is to be used when a District Traffic Unit receives Traffic Signal Structural Support Drawings from the Materials Unit for approval. Below are a series of steps to aid in the review and approval of the drawings using the Publication 148 Traffic Standards: Signals – TC 8801. If any of these steps are not met, reject the drawing and a resubmission is needed.

If using Mast Arms and Type A Foundation:

- Note mast arm length. If mast arm length is less than 31', it must be one section.
- If using two mast arms that are perpendicular, check values based off of longer arm value.
- Number of anchor bolts used must be 6.
- Check if DIAMETER of anchor bolt is adequate.
- Refer to Publication 148 (Traffic Standards – Signals) sheet 3 for appropriate anchor bolt LENGTH.
- Check if BOLT CIRCLE is adequate.
- Check if HOLE for anchor bolts is adequate.
- Check if D (diameter of foundation if circular or side of foundation if square) is adequate.
- Check if H (depth of foundation) is adequate. If using a luminaire or if providing future addition of luminaire via an overlap slip joint, increase H by 8".
- Check if QUANTITY of W bars is adequate. W bars should all be SIZE #9.

If using Mast Arms and Type B Foundation (only use Type B when physical conditions prevent placing the Type A Foundation to its required depth):

- Note mast arm length. If mast arm length is less than 31', it must be one section.
- If using two mast arms that are perpendicular, check values based off of longer arm value.

- Number of anchor bolts used must be 6.
- Check if DIAMETER of anchor bolt is adequate.
- Anchor bolt LENGTH is equal to “Y” or “Z” depth minus 6”.
- Check if BOLT CIRCLE is adequate.
- Check if HOLE for anchor bolts is adequate.
- Check if D (diameter of foundation if circular or side of foundation if square) is adequate.
- Check if QUANTITY of W bars is adequate. W bars should all be SIZE #9.
- Check if SIZE of L bars is adequate.
- Check if “Y” or “Z” depth is adequate (used to calculate anchor bolt LENGTH), then check if appropriate S dimension (side of foundation) is adequate. Note that S dimension increases when using two mast arms.

If using Strain Poles and Type A Foundation:

- Note design tension of strain pole. See Publication 149 for guidance on design tension.
- Check if nominal diameter of the span wire is adequate by ensuring the breaking strength equals or exceeds the design tension.
- Note shaft length of strain pole.
- Number of anchor bolts used must be 6.
- Check if DIAMETER of anchor bolt is adequate.
- Refer to Publication 148 (Traffic Standards – Signals) sheet 3 for appropriate anchor bolt LENGTH.
- Check if BOLT CIRCLE is adequate.
- Check if HOLE for anchor bolts is adequate.
- D (diameter of foundation if circular or side of foundation if square) must be 3’.
- Check if QUANTITY of W bars is adequate. W bars should all be SIZE #9.
- Check if foundation depth (H) is adequate.
- If using luminaire arm, check if mounting height (X) is adequate.

If using Strain Poles and Type B Foundation (only use Type B when physical conditions prevent placing the Type A Foundation to its required depth):

- Note design tension of strain pole. See Publication 149 for guidance on design tension.
- Check if nominal diameter of the span wire is adequate by ensuring the breaking strength equals or exceeds the design tension.
- Note shaft length of strain pole.
- Number of anchor bolts used must be 6.
- Check if DIAMETER of anchor bolt is adequate.
- Anchor bolt LENGTH is equal to “Y” or “Z” depth minus 6”.
- Check if BOLT CIRCLE is adequate.

- Check if HOLE for anchor bolts is adequate.
- D (diameter of foundation if circular or side of foundation if square) must be 3'.
- Check if QUANTITY of W bars is adequate. W bars should all be SIZE #9.
- Check if SIZE of L bars is adequate.
- Check if "Y" or "Z" depth is adequate (used to calculate anchor bolt LENGTH).
- Check if appropriate S or S<sup>L</sup> dimension (side of foundation) is adequate. Use S<sup>L</sup> when installing luminaires.

### Purchase of Preemption Systems

PennDOT will purchase the receiver (detector) on the traffic signal pole; however, the municipality must purchase the vehicle emitter. The District needs to agree with the purchase of the preemption system and this would only be acceptable if appropriate money has been dedicated by the District. Discretion of District Traffic Engineer will be used on the type of device to be used.

### Request for Proprietary Specifications

The Department will only accept the following proprietary specifications:

- Controllers
- Traffic Signal Structural Supports
- Accessible Pedestrian Signals (APS)
- Emergency Preemption devices that use the lock out feature
- Video Detection Systems using the same software throughout the Municipality
- Type 170 or 2070 software requests
- Adaptive Traffic Control Systems
- Controller Software
- Spread Spectrum Radio which is part of an existing system
- Battery Backup
- Additional future items that are identified in the list above

Publication 51 discusses the use of proprietary items. Occasionally the Department receives requests from municipal officials to specify a particular brand of traffic signal equipment in the special provisions for a project. Although it is the policy of the Department and the Federal Highway Administration to use non-proprietary specifications on all projects, review requests of this type to determine if this equipment is essential for compatibility with existing signal equipment or if it is in the public interest to obtain major signal hardware from a particular manufacturer.

It is important to consider any proprietary specifications early in preliminary design to obtain any necessary approvals and to help the municipal officials understand all cost implications.

Therefore, if there is more than one non-proprietary product or material that will fulfill the requirements for an item of work or project, prepare the PS&E for the project to allow all such materials providing:

- All products are of satisfactory quality and are equally acceptable based on an engineering analysis.

- The anticipated prices for the related items of work are approximately the same.

To be in the public interest, the municipal officials must document that at least one of the following is true:

1. More than 75 percent of the existing traffic signal equipment in their municipality is from one particular manufacturer, and the municipality can provide documentation that it has substantial inventory of that manufacturer's spare parts, and their maintenance personnel have received extensive training and are experienced in the installation and maintenance of this brand of equipment.

A municipality that uses a signal maintenance contractor for major controller repairs or installation may still satisfy the above criteria for controllers. However, the contractor would not qualify if they maintain equipment for various municipalities using other brands of equipment.

2. Reasons why a "generic" material description cannot be used or at least three companies cannot be specified. Examples of acceptable justification are:
  - The item is essential for synchronization with existing highway facilities and no suitable alternatives exist.
  - The item is being used for research or for relatively short sections of road for experimental purposes.
  - No other item exists that is of acceptable quality.
  - When a single intersection is either being added to or replaced within an existing coordinated system.

After the municipal officials provide written documentation that their signal program satisfies these criteria, the District should review the information and submit it with their recommendation to BOMO for concurrence.

### Requests for Change of Signal Equipment

On some Department construction projects, the municipality has objected to the type of traffic signal equipment proposed for use by the contractor and has requested that alternate equipment be installed.

If the District agrees with the change(s) in traffic signal equipment the municipality wishes to make, and if the proposed equipment adequately provides the required functions and operation and has a certificate of approval, the request for change may proceed as follows:

- After the contract award, the municipality should request permission to make a change and to negotiate this change with the contractor. The municipality's request must include the specific item or items they wish to change.
- If the District concurs with the municipality's request, obtain all necessary approvals, after which the District may grant the municipality permission to negotiate with the contractor.

If the change requested by municipality increases the cost, the municipality must bear the entire cost increase. If the cost is less, the Department must receive the benefit of the cost reduction.

### Light Emitting Diodes (LEDs)

All LED modules shall be a type listed in Publication 35 (Bulletin 15) Section 1104.06. The [Traffic Signal Portal](#) includes the Approved Products Listing for:

- 12-Inch LED Vehicle Arrow Traffic Signal Modules



- Circular LED Vehicle Traffic Signal Modules
- LED Countdown Pedestrian Signal Modules
- LED Pedestrian Signal Modules

#### LED Minimum Useful Life

Table 6 in [NCHRP Synthesis 371](#), Managing Selected Transportation Assets: Signals, Lighting, Signs, Pavement Markings, Culverts, and Sidewalks, indicates that the mean life expectancy of LEDs is 7.2 years.

The Department has established the policy that if an LED module fails to function as intended due to workmanship or material defects within the first 60 months from the date of delivery, the manufacturer shall replace or repair the module at no additional expense (This includes all maintenance and protection of traffic, labor, installation, and other associated fees) to the local municipality or the Department. (This is a condition on the Department's certificate of approval (COA) signed by each LED manufacturer.)

The relationship of how the luminous intensity of LEDs degrades over time has not been firmly established. However, LED manufacturers are required to replace or repair, within the first 60 months from the date of delivery, any red, yellow, green, or arrow LED signal module that does not meet the luminous intensity described in the applicable ITE national specifications. Therefore, it is strongly recommended that the owner and/or maintainer of the traffic signal equipment obtain the actual delivery date of each LED signal module, and then perform and document visual inspections of each LED signal head module within the first 60 months from the date of delivery. The supplier and/or manufacturer should be notified of any observed degradations during this initial 60-month period.

After 60 months from the date of delivery, the owner and/or maintainer of the traffic signal equipment should continue the visual inspections of LED signal modules. When a noticeable degradation appears, either replace the LED signal module or test it (using the 44-point or other test prescribed in the specifications) to ensure that it continues to have proper luminous intensity.

### **Certificates of Approval**

#### **General**

The Department maintains a program to approve power-operated traffic control devices. It requires testing the equipment under field conditions to evaluate the functional and operational features of the equipment at an intersection. Although the Department supervises these tests, the tests are a cooperative effort between the municipality, the manufacturer, and the Department.

All data concerning equipment approved by the Department is computerized and is available to District personnel. Publication 35 also lists approved equipment.

#### **Application Procedure**

Manufacturers that wish to have a device considered for possible approval must submit a completed application to BOMO. All completed applications must be accompanied by an operation or instruction manual, a copy of specifications for the product, and 15 copies of descriptive literature for the device. In addition, the manufacturer must submit independent laboratory test reports to show that the product complies with applicable Department specifications, NEMA Standards, and other requirements.

Since the Department is not equipped to test power-operated traffic control devices, the equipment must be installed under actual field conditions to permit functional and operational testing under the Department's supervision. Prior to this testing, a Provisional Certificate of Approval will be issued to the

manufacturer, provided the equipment appears to perform the functions and operation required by policies and regulations. The provisional approval will be in effect for a period of at least 6 months, but not to exceed 18 months, after initial installation of the equipment to permit the necessary evaluation and testing of the equipment. This approval will permit the sale of the equipment to any municipality in Pennsylvania provided the municipality has been advised in advance that the equipment has provisional approval and the manufacturer or its representative has first obtained concurrence of the Transportation Operations Division, Department of Transportation, for each installation of such equipment.

By accepting the Provisional Certificate of Approval, the manufacturer agrees to replace all equipment installed under that provisional approval should the Department or the municipality determine that its operation is unacceptable. The replacement equipment shall be approved equipment that is acceptable to the Department and the municipality, and may be from another manufacturer. The manufacturer or its representative shall keep an accurate record of all maintenance and repairs to the equipment during the period of provisional approval. If the equipment operates satisfactorily for the prescribed period, the Department will issue a Sale Certificate of Approval.

## 4.8 Operation

### General

After traffic signals are installed, traffic volumes change and new technologies are developed. Therefore, the Department encourages municipalities to reexamine the traffic signal timing and the equipment about every 3 to 5 years to see if changes would be helpful to improve traffic flow and safety. The “retiming” of a traffic signal should reduce not only delays, but also reduce emissions and motorist fuel costs.

When traffic signal retiming activities are to occur, the Department recommends referring to the Federal Highway Administration’s (FHWA) [Traffic Signal Timing Manual](#). This Manual is a comprehensive guide of traffic signal timing concepts, analytical procedures, and applications based on current practices. In addition, refer to Publication 191, Chapter 6.

Traffic signal equipment upgrades, and phasing and timing changes usually require modification of the traffic signal permit.

### Types of Operation

#### Flashing Operation of Traffic Signals

##### New Traffic Signal Installations

In an effort to better acclimatize motorists to the presence of a new traffic signal installation, it is normally desirable to put the new traffic signals on flash prior to the start of the normal stop and go (red/yellow/green) operation.

Flashing new traffic signals is discussed as part of the operational testing in the section [Operational Testing and Guarantee](#) on page [4-76](#), and in Section 1104 of Publication 408.

##### During Periods of Low Traffic Volumes

Consider flashing operation when the total vehicular volume drops below 325 (urban) or 225 (rural) vehicles per hour for a period of 4 or more consecutive hours. Although these volumes are the basic criteria used to establish the hours of flashing operation, this does not preclude the use of time-of-day to specify the periods of flashing operation for signals at shopping centers, industrial plants, or locations where periods of

flashing operation are needed. For these situations, the District will indicate the hours of flashing operation on the permit diagram.

Do not use a flashing mode of operation if an engineering and traffic study indicates that a sight distance problem exists; the number or severity of crashes increased when the signals were flashed; or there was an increase in observed unsafe conflicts.

**Traffic Signal Retiming Policy**

(Reserved)

**Flashing Operation during events (winter, etc...)**

Flashing operation of a traffic signal, or modification to the timing that are not on the permit plan are not recommended and must be discussed with the District Traffic Engineer. This includes switching to flashing operation during winter snow storms or other non-typical events.

**Operational Responsibility of the Traffic Signal Owner**

Pa. 67 § 212. Assigns the installation, maintenance and operational responsibilities of traffic signals to the municipalities. Therefore, municipalities own the traffic signals in their jurisdiction, and assume the maintenance and operational responsibilities. Refer to [Exhibit 4-1](#) Responsibilities of Local Authorities and the Department.

**4.9 Construction**

**General**

Traffic signals on state or local highways may be installed by contracts administered by the local authorities, municipal forces, contracts related to highway occupancy projects, or Department construction contracts.

Local authorities are responsible for the inspection of the traffic signals that they have installed. The Engineering District will provide inspection for signals that are included in Department contracts or are installed in conjunction with Highway Occupancy Permits issued by the Department for work on State highways.

The Engineering District will review the completed permitted signal installation to verify that it complies with the signal permit requirements for signal design, controller operation, signing, and pavement markings.

Costs associated with the installation of traffic signals shall be the responsibility of the municipality where the signal is located unless the municipality enters into an agreement with another party who assumes all or part of these costs. Signal installation costs associated with Highway Occupancy Permit projects are generally funded by the permittee. The Department will participate in the cost to install or upgrade a traffic signal only when a Department construction project creates the need for a new signal or the need to revise an existing signal.

**Operational Testing and Guarantee**

Section 1104 of *Publication 408* specifies that for presently unsignalized intersections, the initial turn-on is to be in the flashing mode for 3 to 7 days. In light of current practices, the number of days may be 3 to 5 days providing that it includes a minimum of 2 weekdays prior to beginning the normal stop-and-go mode of operation.

With reference to the 30-day operating test specified in Publication 408, it should be noted that failures which are not attributed to defective equipment or faulty workmanship should not be cause for restarting the

If a storm or power outage occurs within the 30 day test, then the 30-day test should be restarted.

30-day test. As an example, damage caused by crashes not resulting from malfunctioning equipment or damage to underground electric conductors caused by pavement break-up should not be cause for restarting the 30-day test at Day 1. However, the test period should be temporarily halted for any such malfunctions and resumed only when all equipment is restored to operating condition. If the operation test is prolonged to an extent that the equipment should be serviced in accordance with the manufacturer's recommendations, the contractor shall provide that service as prescribed in Publication 408.

Moreover, Publication 408 specifies that all traffic signal installations that are part of a traffic signal system, as specified in the proposal or shown on the drawings, shall be tested as a unit. Therefore, it is imperative that each signal installation in a signal system be tested individually, and also that all signal installations within a system be tested as a whole with a separate system test.

The intent of Publication 408's 180-day guarantee period from the date of completion of the 30-day test is for the contractor to guarantee the in-service operation of mechanical and electrical equipment, related components, and the controller assembly during this period. The contractor will be responsible for replacing faulty workmanship and repairing or replacing defective materials or equipment, and correcting malfunctions. On the other hand, damages resulting from crashes, damages not resulting from defective or malfunctioning equipment or faulty workmanship may be beyond the contractor's control and may be the responsibility of the signal owner. The aforementioned examples are not all inclusive and the existence of one or more does not automatically relieve the contractor of his responsibility. Use engineering judgment to determine the responsibility for the failures. When the failure or malfunction is the responsibility of the contractor, the Department, rather than the municipality, should notify the contractor.

### **Traffic Signal Testing 30-Day Testing Procedure**

(Reserved)

### **Acceptance of Traffic Signal Materials**

Accept the following material on construction projects by certification based on their appropriate [Publication 408](#) reference:

Traffic Signal Support, Mast Arm	<a href="#">Section 951.2</a>
Traffic Signal Support, Strain Pole	<a href="#">Section 951.2</a>
Traffic Signal Support, Pedestal	<a href="#">Section 951.2</a>
Controller Assembly	<a href="#">Section 952.2</a>
Traffic Signal Systems and Communication	<a href="#">Section 953.2</a>
Electrical Distribution System	<a href="#">Section 954.2</a>
Signal Heads	<a href="#">Section 955.2</a>
Detectors	<a href="#">Section 956.2</a>

All traffic signal materials should be placed onto Form CS-201 which can be downloaded from, <ftp://ftp.dot.state.pa.us/public/PubsForms/Forms/CS-201.xlt>. The Districts will review and check the form, except for the structural support poles.

In accordance with Department of Transportation Specifications, the Engineer may accept certification of materials in lieu of inspection and testing. Therefore, all traffic signal materials included in Publication 408 and the special provisions will be accepted by certification using PennDOT CS-201 form. In addition, those traffic signal materials which must have a Certificate of Approval issued by the Department shall be

tabulated and submitted to the Engineer by the contractor. Acceptance of the materials tabulated for traffic signal items means only that the materials are suitable for the proposed use.

The materials tabulation shall be submitted for each project within 3 weeks of the Notice-to-Proceed. This tabulation shall include the following project information:

- State Route
- Section
- County
- Prime Contractor

Also, provide the following information for each different item of material:

- Identity of Material
- Manufacturer's Name
- Manufacturer's Model Number
- Department's Certificate of Approval Number

Accessories, such as hardware, brackets, supplies, minor devices, etc., necessary for the proper installation of traffic signals but not in Publication 408 or the special provisions are not intended to be submitted for testing and acceptance. However, all load-carrying accessory materials shall be certified as to their structural adequacy for the loads indicated.

Request catalog cuts only if they are necessary to provide clarification of special features or functions of the proposed materials.

The contractor shall submit three copies of traffic signal materials tabulation to the District Executive, attention Assistant District Executive, Construction, for review and acceptance. The review by the District staff should include contact with the appropriate municipal officials, if necessary. The District should notify the contractor by letter, of the acceptance or rejection of his submission. If rejected, indicate the reason in the letter.

### **Final Acceptance of a Traffic Signal**

Final inspection of a traffic signal that has been installed on a Department construction project should be similar to that used when making a final inspection of municipally-installed signals. Therefore, the District Traffic Units should adopt the following procedure, as a minimum, to ensure municipal input is obtained prior to assigning them signal ownership:

- Notify the municipality in writing of the starting date of the 30-day test, and any extensions thereof, and advise them that they must be present. It is also recommended that the consultant/designer be present.
- Upon successful completion of the 30-day test, invite the municipality to any final inspection meeting. Verbally advise the municipality, with a written confirmation, of the Department's acceptance of the signal and that they are now responsible for the continued operation and maintenance of the signal in accordance with the provisions of the traffic signal application and permit, the traffic signal maintenance agreement, and Commonwealth regulations.

### **Guidelines for Traffic Signal Construction Inspection**

#### **Material Approval**

BOMO issues a Certificate of Approval (COA) to manufacturers authorizing the sale of specific electrically-operated traffic signal equipment. Contractors are responsible to tabulate a list of the proposed equipment

within 3 weeks after the Notice to Proceed, and to submit the list to the Department. BOMO also approves standard loadings for traffic signal supports, but shop drawings are submitted, and design calculations will be required for non-standard loadings.

Districts should accept materials when accompanied by a certification stating compliance of the material to the appropriate specification.

Three copies of warranties, guarantees, instruction manuals, wiring diagrams, field wiring diagrams, and parts lists are required and one copy of each should be retained as follows:

- Department file.
- Municipal file
- Retained in the controller cabinet.

### Testing

The contractor is required to perform tests on various items during the construction of a traffic signal project. Documentation of some test results is required by the contractor, all other tests will have to be documented by the inspector. Following is a tabulation of required tests with references to the section of the specification requiring the test.

The following tests must be performed using equipment manufactured for the specified test. The equipment should contain the manufacturer's instructions on its use.

- Sec. 1104            Controller Assembly Shop Test.
- Sec. 1104            Traffic Signal Installation 30-Day Operating Test.
- Sec. 952.3(a)        Malfunction Management Unit or Conflict Monitor Function Test.
- Sec. 952.3(b)        Time Clock Evaluation.
- Sec. 953.3(d)        30-Day Systems and Communications Test.
- Sec. 954.3(j)        Traffic Signal Circuits Test for Short Circuits, Unspecified Grounds, and Resistance to Earth Ground.
- Sec. 956.3(a)        Loop Detector Leakage Resistance, Series Resistance, and Inductance Testing.
- Sec. 956.3(a)        Earth's Magnetic Flux Test and Magnetometer Detector Leakage and Series Resistance Test.
- Sec. 956.3(a)        Magnetic Detector Leakage and Series Resistance Test.
- Sec. 956.3(b)        Pedestrian Pushbuttons Evaluation and Pedestrian Phase Timing Test.
- Sec. 953.3(k)        Traffic Signal Communications Test for Short Circuits, Unspecified Grounds, and Resistance to Ground.

### Revisions

Consult the District Traffic Engineer or designated representative prior to approving any changes from what is shown on the drawings.

### Foundations

Check the following items:

- Correct location?
- Is there adequate clearance between traffic signal support and overhead utility lines at this location?
- The One-Call indicates no underground conflicts.
- Is excavation large enough for the required foundation?
- Prior to placing cement concrete, ensure that the following items are in-place and adequately supported:
  - Is the ground rod in-place and was it resistance tested? Is an additional ground rod at least one length away from and bonded to the first?
  - Is reinforcement in-place with proper clearance between it and the outside edges of foundation?
  - Are anchor bolts the correct size, and free of dirt, grease, or other foreign matter? Is the projection of bolts sufficient to adjust the rake of the support?
  - Is the conduit the proper size and quantity?
- Are the top of foundation forms the correct size and elevation, and are provisions made for chamber on edges of foundation?
- Is expansion joint filler between existing pavement and foundation?
- Are the conduits capped and threads on anchor bolts protected during placement of concrete?
- Is the cement concrete cured for 72 hours before placing support?

### **Traffic Signal Supports**

Check the following items:

- Is the approval number on base plate of shaft and flange plate of arm?
- Is there any damage to galvanizing?
- Is support placed on the foundation with the proper rake to provide vertical set when the load is applied?
- Is the ground wire from the ground rod connected directly to the lug inside the handhole, with no other ground wires connected to the lug? Are all other ground wire(s) in base of support connected to the aforementioned ground wire with an appropriate clamp?
- Is the cover on the handhole?
- Is the cap on top of shaft?
- Is the cap on end of arm (mast arm)?
- Are grommets protecting all holes for wire outlet in arm (mast arm)?
- Is the wire entrance near top of shaft?
- Are the span wire clamps and tether wire clamps in correct location?
- Is the proper sag in span wire with load applied?
- Are signal cables properly lashed to span wire?
- Is the ground wire connected to the span wire and strain pole?
- Are the electrical cables inside shafts supported with clamp attached to cable support in top of shaft?
- Is mortar between the foundation and base plate, with a drain hole?

### **Controller Assembly and Traffic Signal Systems**

Since a representative of the District Traffic Engineer will be present when a traffic signal is placed in operation, the inspector should be primarily concerned with installation of the cabinet and determining that

all required equipment is contained in the cabinet. To aid in identification, much of this equipment is labeled with the manufacturer's name, serial number, and model or part number.

- Was controller assembly shop tested?
- Is the cabinet located and oriented so that you can observe the equipment in the cabinet and the signals at the intersection simultaneously?
- If the cabinet is on a traffic signal support, is it at the required elevation and attached with the required hardware? Does it project into the accessible route? Does it meet ADA requirements for detection of protruding objects by a visually impaired person? (See Section 307 in the ADA requirements, available at <http://www.access-board.gov/ada-aba/final.pdf>).
- If the cabinet is on a cement concrete foundation, refer to Publication 148 standard for a traffic signal support foundations. Is a drain hole provided in the foundation, and is caulking between the bottom of cabinet and the foundation?
- Is the cabinet the proper size?
- Are devices in cabinet mounted on a shelf or a rack?
- Is the cabinet equipped for maximum phase capability of the controller unit?
- Is the cabinet ventilated?
- Does the exhaust fan operate as required?
- Are there an adequate number of terminal blocks?
- Are controller modules and load switches labeled as to function?
- Are all switches, controls, and indicators clearly identified?
- Flasher?
- Time clock?
- Are switches in the police panel and was a manual cord provided?
- Are there pushbuttons for simulated detector operation?
- Do you have written documentation of the malfunction management unit or conflict monitor test?
- Does the preemption work? Extensive testing is required for intersections with railroad preemption.
- Are spare and reserved conductors terminated on the ground bus?
- Electric Load Center:
  - Are the circuit breakers sized in accordance with load?
  - Is a ground fault circuit interrupter provided for the duplex receptacle?
  - Surge Protector?
  - Radio Frequency Interference Filter?
- Grounded conductors on neutral bus?
- Grounding conductors on grounding bus?
- All stranded conductors provided with insulated spade terminals?
- Are all wire terminal screws tightened?

### Electrical Distribution

Check the following items:

- Electric service.
  - Service pole location.
  - Cabinet for disconnect.
  - Fuses rating for not less than load.
  - Switch rating not less than load.
  - Surge protector.



- Ground rod resistance tested.
  - Service wire sized in accordance with load.
- Trench. Excavated to required depth and width? Was the pavement cut prior to beginning excavation with no large or sharp rocks in first layers of backfill? Was the backfill properly compacted?
- Conduit. Is it cut normally with saw? If cut by other means, was the conduit distorted or crushed? Were bends made without kinks? Is all metallic conduit bonded?
- Grounding. Are all ground rods in a signalized intersection interconnected with ground wire? Note, in a span wire installation, the span wire is used as a ground wire between strain poles.
- Signal Cable. Was it damaged when pulled through conduit and traffic signal supports? Is the cable only spliced in the base of traffic signal support? Are all spliced conductors in base of support identified with cable tags which indicate phase and function? Are all unused conductors terminated on grounding bus in the controller cabinet? Were all signal circuits tested for short circuits, unspecified grounds, and resistance to ground?
- Junction Box. Is a drain hole in the bottom and coarse aggregate below box for drainage? Do all junction boxes satisfy the minimum dimensions; i.e., boxes may be provided with larger dimensions?

### Signal Heads

Check the following items:

- LED modules or lamps correct size?
- Where lamps are used, if filament in lamp is "U" shaped, is opening in filament in the up position? Can this be accomplished by rotating socket?
- Is the LED module or lens oriented according to manufacturer's recommendations (e.g., top of lens or module at top of signal head)?
- Are signal heads located correctly in regard to roadway; i.e., aimed correctly and plumb?
- Is the top of all overhead signals facing an approach at the same elevation?
- Are all specified visors, louvers, and backplates in-place?
- Is the vertical clearance of signal heads proper?
- Are the signals wired in accordance with specified color code?
- Is a drip loop in cable provided at entrance to signal head?
- If present, were optically programmed signals programmed in accordance with the instructions provided with the signal head?
- Are arrow indications oriented in the proper direction?
- Are non-operating new signals bagged?
- Are existing signals remaining in operation until the new signals are put into operation?

### Detectors

Most vehicle detectors are loop detectors; but other forms of vehicle detection such as video are seeing increased use. The following information pertains to loop detectors, but it can be as a reference for other forms of detection along with manufacturer's recommendations.

#### Loop Detectors

Check the following items:

- Are the sensors (loops) the correct size and located as required, avoiding all unstable pavement, cracks, and joints if possible?

- Will the loops detect all vehicles, including bicycles and motorcycles?
- Are the saw slots for sensors the correct depth and width?
- Is the inside of the slot smooth with no sharp edges?
- Does the conduit for the sensor lead from roadway to junction box or controller cabinet as required?
- Was the saw slot blown free of moisture and debris with compressed air prior to placing sealant?
- Was the sensor wire placed in slot, and held in slot with short pieces of closed-cell polyethylene foam or small pieces of cable jacket?
- Are the number of turns of sensor wire as recommended to provide required inductance?
- Were the two leads from sensor twisted together before placed in conduit?
- Was the sensor wire tested for leakage and series resistance?
- If sensor wire is not spliced to lead-in immediately, were the ends of sensor wire and tubing sealed to prevent entrance of moisture?
- Are the sensor wires securely spliced to lead-in cable?
- Was duct seal placed in the end of conduit before placing sealant?
- Was the sealant prepared in accordance with manufacturer's instructions and placed in slot without voids and without overflowing slot?
- Are there any splices in the lead-in cable (none are permitted)?
- After the sensor was spliced to lead-in cable, was the inductance measured and recorded for each sensor? Is a copy of the test in the controller cabinet?
- Were the settings on the amplifier properly adjusted?
- Are the amplifiers labeled as to function?

#### Pedestrian Pushbuttons

Located to be readily visible and accessible to a pedestrian that is in position to use the crossing.

- Trench
- Conduit: Refer to Section 954 – Electrical Distribution
- Junction Box

#### **Responsibilities of the Construction Inspector Regarding a Traffic Signal**

It is the responsibility of the inspector to check all of the hardware equipment. The DTE will check the operations, and timing.

## **4.10 Maintenance**

### **General**

Traffic signal maintenance shall be provided by the local authorities unless they have an agreement with another entity indicating otherwise. Maintenance should be done in accordance with the Department's Publication 191, *Guidelines for the Maintenance and Operations of Traffic Signals*. If state or federal funds have been used to pay for the installation of the signal, maintenance must be provided as indicated in Publication 191.

Costs associated with the operation and maintenance of traffic signals shall be the responsibility of the municipality where the signal is located unless the municipality has an agreement with another party who assumes all or part of these costs.

## Annual Program

As described in Publication 191, the Department may periodically evaluate signal maintenance performance of the municipalities involved in State or federal-aid projects to determine how well the municipality is fulfilling its maintenance responsibilities on these projects. Municipalities may use this information as a guide in determining their capability and to aid in deciding whether to use a private contractor for traffic signal maintenance.

## Traffic Signal Maintenance and response responsibilities

The “Commonwealth and Municipal Traffic Signal Maintenance Agreement” is between the Department and the municipality, and it addresses the required maintenance and operation of the traffic signal installation. This traffic signal maintenance agreement can be for a single intersection, or for multiple signalized intersections within the municipality. This document is a standard statewide agreement that contains very detailed maintenance responsibilities of the municipality, and requires the municipality to attach a copy of the municipal resolution that authorized the execution and attestation of the traffic signal maintenance agreement. A copy of the template for the traffic signal maintenance agreement is included in Appendix C. Additionally the traffic signal maintenance agreement should not be altered from the already approved language from the Department’s Office of Chief Counsel.

The traffic signal maintenance agreement requires the municipality to also note if maintenance will be done with municipal personnel or via contract, and if by contract, it requires a municipality to provide the name of the contractor and a copy of the traffic signal maintenance agreement or contract that the municipality has with the contractor.

The “traffic signal maintenance agreement” includes the following five exhibits which are further clarified below:

- A. Preventive and Response Maintenance
- B. Recordkeeping
- C. Signal Maintenance Organization
- D. Contractor Integrity Provisions
- E. The Americans With Disabilities Act
- F. Contract Provisions – Right to Know Law 8-K-1532

## Project Reviews

Proper maintenance of traffic signal equipment is necessary to ensure the efficient and safe movement of traffic. Therefore, the Department may: (1) make itself available to aid and (2) evaluate the maintenance capability of the responsible municipality prior to the final design of any project which includes traffic signals.

FHPM 6-4-3-1 requires that all completed projects constructed with federal-aid funds be maintained at an acceptable level of physical integrity and operation, consistent with its original design standards. Failure on the part of the state or municipality to do so can result in the withholding of future federal-aid funds unless and until the appropriate corrective action is taken by the responsible agency.

## Maintenance Contracts

Information on Maintenance Contracts can be found in Publication 191, sections 8.5 and 10.

---

## Maintenance Evaluation Procedures

### Overview

Traffic signals may not be installed or revised using state or federal funds unless the municipality is able and willing to properly operate and maintain the new equipment. A determination of their ability may be made by the Department following a review of the municipality's staff, budget, maintenance shop, spare parts inventory, and most importantly, their past performance in maintaining traffic signals.

If a municipality is incapable or unwilling to perform the required maintenance of the proposed new equipment, one or more of the following may be considered:

- The proposed new equipment may be changed to a type of equipment that provides the same functions and can be maintained by the municipality.
- The municipality may be encouraged to upgrade its staff, budget, or inventory to allow for proper maintenance.
- The municipality may retain a qualified, competent contractor to provide maintenance.

If none of the above options (or any other which will ensure proper maintenance) are possible or agreeable, signal improvement projects in the municipality may:

1. not be advanced to final design or construction using federal or state funds,
2. be deleted from the project if it is part of a larger construction project, or
3. be designed and constructed entirely with local funds.

In order to prevent wasted design costs, it is desirable to make the determination of municipal maintenance capability prior to initiation of final design. At that time, the municipality will be required to enter into an agreement that details the signal maintenance effort that must be provided throughout the useful life of the proposed improvement.

The agreement, for those municipalities who are judged to be currently providing an adequate level of maintenance, should describe the existing function (staff, budget, etc.) and require that, as a minimum, it be retained. The agreement must list those changes that are to be initiated and provided throughout the useful life of the proposed project. Typically, the required changes will include items such as increased staffing, additional training for existing staff, budget increases, retention of a maintenance contractor, etc.

### Evaluation of Maintenance Function

It is important to consider not only the adequacy of an existing maintenance function, but also the ability of the municipality to properly maintain additional signal equipment which may or may not be similar to the equipment they presently service.

"Ability to maintain" is a complex, many-faceted characteristic that cannot be simply or directly measured. Rather, each of its components must be studied in its own context and an overall rating of the function pieced together. The experience of the rater, the degree of cooperation offered by the municipality, the municipality's performance in relation to that of surrounding municipalities, and many other non-measurable factors may influence the final rating.

Recommended steps in the evaluation process are as follows:

1. Step 1 – Use of Maintenance Capability Checklist.

As soon as possible after a project, which includes traffic signals, receives PMC approval for design, the involved municipality may be forwarded a copy of the checklist with instructions to complete and return it within a reasonable period of time.

The completed form will be reviewed to determine if there are any obvious deficiencies in the municipality's maintenance functions.

The use of the checklist and forms in Section 7.0 of Publication 191 will help determine if the municipality's preventative and response maintenance efforts are acceptable and at what level they are being performed. It must be remembered, however, that the level at which the response maintenance effort is being performed is not a qualitative measure of performance, but rather an indication of the type of response maintenance program being employed by the municipality.

The checklist is not intended to be an end in itself and may be used in combination with an interview/meeting to arrive at a meaningful evaluation. Although many of the questions in the checklist may be answered with a "yes" or "no," the complete answer to the question often can be ascertained via a discussion with the municipal officials who are directly responsible for the maintenance program.

2. Step 2 – Field Evaluation.

The results of the checklist and interview procedure will, in many cases, paint a picture of the maintenance effort as it is perceived by the municipality. The true test, however, lies in its application, and can be more directly measured by reviewing the condition and operating characteristics of their existing signal equipment. In addition to what the checklist and interview reveal, the existing signal equipment must operate dependably and be returned to service quickly, when it malfunctions, in order for a maintenance function to be judged acceptable.

The field review may be performed prior to, or immediately after, the interview/ meeting, but both should be done by the same individual(s). By conducting the field review prior to meeting with the municipality, however, it would be possible to identify the areas of weakness as evidenced in the field.

3. Step 3 – Ability to Maintain Additional Equipment.

Completion of the first two steps should provide a clear picture of the type and number of traffic signals that can be properly maintained, given: (1) the number of personnel assigned to the function; (2) their level of experience and training; (3) the available inventory and equipment; and (4) the budget that supports them.

The maintenance requirements of the proposed equipment should then be determined and compared to the municipality's capabilities.

The two basic questions that need answers at this point are:

- i. Can the municipality provide adequate maintenance for the traffic signals proposed in this project?
- ii. If not, what must the municipality do to ensure adequate signal maintenance throughout the useful life of the equipment?
  - Should the signal maintenance budget be increased? If so, by how much?
  - Are additional maintenance personnel needed? How many and at what level?

- Do existing personnel require additional training?
- Should the municipality purchase specific maintenance equipment?
- Should a contractor be hired in lieu of using municipal personnel?

Based on the answers to the above questions, the signal maintenance agreement for the project should be prepared. A standard agreement is used for this purpose.

### Documentation

Keep proper documentation of the procedures followed in evaluating and rating municipal maintenance functions. Documentation may include:

- Any completed maintenance capability checklist; signed and dated by the responsible municipal official.
- Brief narrative of the results of any field reviews including date, attendees, intersections reviewed, description of the visual and operating characteristics of the equipment reviewed, and recommended improvements.
- Minutes of any interviews/meetings including any amplification of answers to the checklist questions and an overall rating of the municipal maintenance function in each of the following areas that apply:
  1. Manpower – number, experience, training.
  2. Inventory – parts, equipment.
  3. Budget.
  4. Maintenance contractor – ability, dependability.
- Listing of the items that must be completed prior to construction of the project, and any other recommendations.
- Agreed upon action plan.

In some cases, because of a recent evaluation for a previous project, the documentation may include verification that no major changes, detrimental to the maintenance program, have occurred since the previous evaluation, and that the municipality is fulfilling the obligations of its existing signal maintenance agreement(s).

### Quality Assurance Review Form

- I. Evaluation Process Review
  - A. District Procedures
    1. Checklist to municipality by letter (Reference Publication 191)
    2. Analysis of returned checklist
    3. Field evaluation
    4. Interview/meeting
    5. Consider effect of new equipment and required changes to municipality's maintenance program
    6. Recommendations discussed with municipality
  - B. District Records
    1. Completed checklist
    2. Narrative of field review
    3. Minutes of interview/meeting
    4. List of action items
- II. Signal Maintenance Agreement Review

- A. Completed properly
  - 1. Prior to final design
  - 2. Format correct
  - 3. Item #4 completed
  - 4. Exhibit D: Personnel requirements and training – completed
  - 5. Contractor's name, address, and its maintenance contract with municipality
  - 6. Signatures and other information completed on signature page
  - 7. Signature resolution by municipality authorizing the signees to execute the agreement, original copy required
- B. Modification to Agreement
- III. Q/A Inspection (field) of Municipality's Maintenance Effort
  - A. Signal lenses clean, colors correct, and light output acceptable
  - B. Signal heads aligned properly
  - C. Sensors maintained and operating (including pushbuttons)
  - D. Controller operation satisfactory
- IV. District Comments on Guidelines, Evaluation Process, Agreements, and Municipality's Reaction

### Warranties

All warranties should be collected and monitored appropriately by the traffic signal owner.

## 4.11 Removal of Traffic Signals

### General

At intersections, traffic control devices regulate the flow of conflicting traffic streams. Since traffic signals provide the strongest form of at-grade intersection control, the public has sometimes erroneously assumed that traffic signals are a panacea for intersection operational or safety concerns. Therefore, due to lack of transportation engineering expertise, or public and political pressure, or both, unwarranted traffic control signals may exist at intersections in some communities. Additionally, at other intersections, changing traffic patterns may have caused signals that were originally warranted to no longer meet warrants. Moreover, the removal of a traffic signal often involves political and institutional considerations as well as technical factors. In keeping with these practical realities, the approach to signal removal justification is a sequential screening process in which a series of criteria must all be satisfied, and the various impacts predicted, before removing a signal.

Knowing the probable impacts on intersection safety, traffic operations (e.g., delay, stops, and fuel consumption), and costs, the traffic engineer can make a sound technical decision on the question of signal removal. Because the removal of a traffic signal often involves institutional and/or political constraints, temper the technical element with professional judgment when making the final decision. The decision process allows for including these institutional and political considerations.

For a complete explanation of the removal process, refer to FHWA IP-80-2, *Users Guide for Removal of Not Needed Traffic Signals*, November 1980.

When the Department initiates the process to remove any traffic signal, no one shall instruct the municipality to begin the removal process until the Secretary of Transportation reviews the study data and approves the removal of the signal. Therefore, when the District Traffic Unit is recommending the removal of a signal, as a minimum, submit the following study data and analysis to the Bureau of Maintenance and Operations for review and submission to the Secretary of Transportation:

- Intersection geometrics
- A 24-hour vehicle volume summary
- Peak hour turning movement counts
- Pedestrian volumes
- Side street sight distance data
- Crash experience and impact analysis
- Completed Traffic Signal Report Form (from Publication 149)
- Special site conditions

Requests to remove traffic signals that originate from the local authorities do not need the Secretary's approval, but in both cases the removal process should be accomplished in accordance with the following:

- a) Determine the appropriate traffic control to be used after removal of the signal.
- b) Remove any sight-distance restrictions as necessary.
- c) Inform the public of the removal study.
- d) Flash or cover the signal heads for a minimum of 90 days, and install the appropriate stop control or other traffic control devices.
- e) Remove the signal if the engineering data collected during the removal study period confirms that the signal is no longer needed.

As noted previously in the chapter, State and federal funds may be used to remove unwarranted traffic signals.

#### 4.12 Adaptive Traffic Control Systems

Traffic adaptive systems perform "real-time" adjustments to the cycle length, splits and offsets in response to traffic demand. Traffic adaptive systems require extensive detection inputs. Complete and accurate traffic flow data must be gathered, processed and communicated to the central computer.

Additional information can be found in NCHRP 403 found at:

[http://onlinepubs.trb.org/onlinepubs/nchrp/nchrp\\_syn\\_403.pdf](http://onlinepubs.trb.org/onlinepubs/nchrp/nchrp_syn_403.pdf)

Additional details and information can be found on the Traffic Signal Portal:

<http://www.dot.state.pa.us/Portal%20Information/Traffic%20Signal%20Portal/index.htm>

#### 4.13 Automated Red Light Enforcement

Currently, Automated Red Light Enforcement (ARLE) is only in place in Philadelphia. The most current information can be found on the Traffic Signal Portal:

<http://www.dot.state.pa.us/Portal%20Information/Traffic%20Signal%20Portal/index.htm>

#### 4.14 Traffic Signal Asset Management System (TSAMS)

(Reserved Section)



#### **4.15 Approved 67 Pa. Code Chapter 205 Municipalities**

No Municipalities with Certification

.

## CHAPTER 5 - LOW-VOLUME ROADS

### 5.1 General

#### Purpose

Part 5 of the *MUTCD* is entitled “*Traffic Control Devices for Low Volume Roads*,” and it provides for a reduction in the number and size of traffic-control devices on “*low-volume roads*.” In general, these roadways are farm-to-market roads, recreational roads, resource management and development roads, and local roads.

Moreover, Section 5A.01 of the *MUTCD*, which defines “*low-volume road*,” as follows, precludes State highways from being a low-volume road:

- a) A facility lying outside of built-up areas of cities, towns, and communities, with a traffic volume less than 400 AADT.
- b) Not a freeway, expressway, interchange ramp, freeway service road, or a roadway on a State highway system.
- c) Classified as either a paved or an unpaved road.

Therefore, some municipal roads may satisfy the definition of “*low-volume road*” and thereby use fewer and smaller traffic-control devices, but this definition never applies to State highways.

#### Laws, Regulations and Other Publications

*Manual on Uniform Traffic Control Devices (MUTCD)*, FHWA. Specifically, Part 5 addresses low-volume roads, and it is available at [http://mutcd.fhwa.dot.gov/pdfs/2009/pdf\\_index.htm](http://mutcd.fhwa.dot.gov/pdfs/2009/pdf_index.htm).

## CHAPTER 6 - TEMPORARY TRAFFIC CONTROL

### 6.1 General

#### General

The *Manual on Uniform Traffic Control Devices (MUTCD)* defines the term “temporary traffic control” as:

“Temporary Traffic Control Zone—an area of a highway where road user conditions are changed because of a work zone or incident by the use of temporary traffic control devices, flaggers, uniformed law enforcement officers, or other authorized personnel.”

Most Department employees refer to this term as “work zone traffic control,” which is the most common type of temporary traffic control.

This chapter provides internal policy for the Department relative to temporary traffic control, supplementing the following other documents in general order of importance:

1. Part 6 of FHWA’s *Manual on Uniform Traffic Control Devices (MUTCD)*, entitled “Temporary Traffic Control.”
2. Subchapter E of 67 Pa. Code, Chapter 212, entitled “Official Traffic Control Devices.”
3. Publication 213, entitled “Temporary Traffic Control Guidelines.”

#### Laws, Regulations, and Publications

- Approved Construction Materials – Bulletin 15 (Publication 35).
- Authorizing Appropriately Attired Persons to Direct, Control, or Regulate Traffic (67 Pa. Code, Chapter 101).
- Engineering and Traffic Studies (Title 67 Pa. Code, Chapter 212).
- Flagging Handbook (Publication 234).
- Handbook of Approved Signs (Publication 236).
- *Manual on Uniform Traffic Control Devices (MUTCD)*.
- Highway Specifications (Publication 408).
- Traffic Control, Pavement Markings and Signing Standards, TC-8600 & 8700 Series (Publication 111).
- The Vehicle Code (Title 75 Pa. C.S.).
- Temporary Traffic Control Guidelines (Publication 213).

#### Definitions

The following words and terms, when used in this chapter, have the following meanings, unless the context clearly indicates otherwise:

*ADT – Average daily traffic* – The total volume of traffic during a number of whole days, more than 1 day and less than 1 year, divided by the number of days in that period.

*Active work zone* – The portion of a work zone where construction, maintenance or utility workers are on the roadway or on the shoulder of the highway, and workers are adjacent to an active travel lane. Workers

are not considered adjacent to an open travel lane if they are protected by a traffic barrier and no ingress or egress to the work zone exists through an opening in the traffic barrier.

Advisory speed – The recommended speed for vehicles operating on a section of highway based on the highway design, operating characteristics and conditions. When posted, the speed is displayed as a warning sign; that is, either a black-on-yellow or a black-on-orange sign.

Delineator – A retroreflective device mounted on the road surface or at the side of the roadway in a series to indicate the alignment of the roadway, especially at night or in adverse weather.

Department – The Department of Transportation of the Commonwealth.

Divided highway – A highway divided into two or more roadways and so constructed as to impede vehicular traffic between the roadways by providing an intervening space, physical barrier or clearly indicated dividing section.

Expressway – A divided arterial highway for through traffic with partial control of access and generally with grade separations at major intersections.

Freeways – are fully-controlled, limited access arterial highways, as per AASHTO Geometric Design of Highways & Streets (Green Book), Chapter 8.

Modes of Transportation – motor vehicles (including buses and trucks), transit, bicycles or pedestrians.

MUTCD – The current edition of the Manual on Uniform Traffic Control Devices, as adopted by the Federal Highway Administration (FHWA), and available on the FHWA website. Specifically, Part 6 addresses temporary traffic control.

Night, nighttime – The time from 1/2 hour after sunset to 1/2 hour before sunrise.

Normal speed limit – The regulatory speed limit or the 85th percentile speed that existed before temporary traffic control was established, for example, prior to the beginning of a work zone.

Public Information Plan (PIP) – a plan that informs the public of the impacts on traffic and the general area during or prior to construction.

Roadway – That portion of a highway improved, designed or ordinarily used for vehicular travel, exclusive of the sidewalk, berm or shoulder. If a highway includes two or more separate roadways, the term refers to each roadway separately but not to all roadways collectively.

Shadow vehicle – A vehicle positioned in advance of a work area or work vehicle to provide advance information to approaching drivers or protection for the workers or work vehicle.

Significant Projects – is defined as one that, alone or in combination with other concurrent projects nearby, is anticipated to cause sustained work zone impacts that are greater than what is considered tolerable based on State policy and/or engineering judgment.

State highway – A highway or bridge on the system of highways and bridges over which the Department has assumed or has been legislatively given jurisdiction.

Traffic Control Plan (TCP) – a supplemental plan currently required for all projects that addresses traffic flow and control through the work zone which must conform to the MUTCD and Publication 213.

Transportation Management Area (TMA) - an area designated by the Secretary of Transportation, having an urbanized area population of over 200,000, or upon special request from the Governor and the MPO designated for the area.

*Transportation Management Plan (TMP)* – lays out a set of coordinated strategies and describes how these strategies will be used to manage the impacts of a project during construction. It includes the TCP, TOP and PIP.

*Transportation Operations Plan (TOP)* – a plan that includes Demand Management Strategies, Corridor\Network Management Strategies, Work Zone Safety Management Strategies and Traffic\Incident Management and Enforcement Strategies.

*Temporary traffic control (TTC)* – An area of a highway where road user conditions are changed because of a work zone or incident by use of temporary traffic-control devices, flaggers, police officers or other authorized personnel.

*TTC plan* – A plan for maintaining traffic through or around a work zone.

*Work zone* – The area of a highway where construction, maintenance or utility work activities are being conducted, and in which traffic-control devices are required in accordance with this chapter.

## 6.2 Safety

### Safety First

Safety in work zones is the Department's highest priority. Therefore, discuss protection of the traveling public and the workers at all meetings with construction, maintenance, and permit/utility personnel.

All traffic control devices used in a work zone shall be clean and in good condition, and all signs must be legible. On any operations in the right of way, do not permit employees to work without proper flagging training as required in the *MUTCD and Publication 213*.

Moreover, in accordance with 67 Pa. Code §212.412 (relating to flagger signaling devices), the red flag may only be used as follows:

“A red flag shall only be used to control traffic in emergencies when a STOP/SLOW Paddle (W21-10) is not available or at intersections when a flagger is used within the intersection.”

Before assigning any new employees as a flagger, including summer help, it is mandatory that they first complete a flagger-training course.

### Pennsylvania State Police (PSP) Cooperation

The Pennsylvania State Police administration has indicated they will cooperate with the Department and provide police assistance for Department construction and maintenance operations on high-volume, high-speed highways within the limits of their manpower.

Give as much advance notice as possible (at least 2 weeks) to the State Police when requests are made for their assistance. It is equally important to notify the State Police of any changes in schedules if police assistance has been requested for specific operations. More information on police assistance is available in **Section 6.15** of this publication.

### Work on Limited Access Highways

The Department has advised AFSCME that in consideration of employee safety, it is the Department's intention to avoid assigning employees to limited access highways during periods when the Department anticipates unusually high traffic volumes.

Specifically, the Department will attempt to avoid working on all four-lane limited access highways on Fridays and the day before the holidays listed in Article 10 of the Master Agreement. In addition, this policy may be applied at other times and on other highways when specific local circumstances create an increased risk to employee safety. However, this general policy shall not prohibit work during emergencies or for work necessary to minimize hazards.

## 6.3 Work Zone Safety and Mobility

### Work Zone Safety and Mobility Policy (WZSM)

The Department is responsible for designing and maintaining work zones that limit the impact to motorists, while maintaining safety for highway workers and the traveling public.

#### Policy Scope

This policy applies to all projects that receive Federal and/or State funds and the following conditions apply:

- Project is located on any of these fully-controlled, limited access highways: interstate, PA Turnpike, or freeway (interstate look-a-like), and
- Project occupies a location for more than 3 days with either intermittent or continuous lane closures.

These conditions meet the “sustained work zone impacts” intent referenced in FHWA’s Work Zone Safety & Mobility Final Rule (23 CFR 630 Subpart J). While the Final Rule centers around interstate projects within the boundaries of a Transportation Management Area (TMA), this policy simplifies the process and encompasses all interstate/freeway projects regardless of being within a TMA or not.

Also, any project meeting the above conditions, along with additional travel times greater than 20 minutes for two consecutive hours, is deemed as a “Significant Project” and must meet further criteria as defined later in this policy.

#### Policy Objectives

The intent of this policy is to provide safe work zones that minimize delay for the traveling public and reduce community impacts while maintaining fiscal responsibility. This policy also is intended to bring the Department into compliance with FHWA’s Work Zone Safety and Mobility Final Rule (23 CFR 630 Subpart J).

The goals of this policy are to:

- Establish a systematic approach for improving work zone safety and mobility that will include the consideration of transportation management and congestion mitigation from the project planning stage throughout the life of the project.
- Expand work zone management beyond typical traffic safety and control within the project footprint to address corridor, network, and regional issues including day-to-day operations and the effective dissemination of public information.

#### Responsible Organizations

The Bureau of Maintenance and Operations (BOMO) and the Bureau of Design (BOD) are responsible for administering this policy for PennDOT. This policy is cross-cutting with all organizations involved in the planning, design, and construction of highway projects. Organizations responsible for implementing this policy include:

- Bureau of Design
- District Offices
- Bureau of Construction and Materials
- Bureau of Maintenance & Operations
- Center for Program Development and Management

### **Program Management**

BOMO will monitor the effectiveness of this work zone policy through Independent Oversight Program (IOP) process reviews, an assessment of work zone performance measures, and coordination with District Traffic Engineers.

BOMO will serve as the lead Bureau for the PennDOT Work Zone Safety and Mobility Committee which will include membership from all Central Office Engineering Bureaus, District representation, and the FHWA. The Committee shall be responsible for reviewing the effectiveness of this policy and making changes as necessary.

### **WZSM Implementation**

This section provides direction for implementing the requirements of PennDOT's Work Zone Safety and Mobility policy.

### **Objectives & Goals**

PennDOT's Work Zone Safety and Mobility policy includes six broad objectives:

- Develop and implement systematic procedures to assess work zone impacts during planning and project development, and effectively manage safety and mobility during project implementation.
- Mitigate traffic and mobility impacts for the project area and for the surrounding network.
- Use field observations, available work zone crash data, and operational information to mitigate work zone impacts for specific projects during implementation. Continually pursue improvement of work zone safety and mobility by analyzing work zone crash and operational data from multiple projects to improve processes and procedures.
- Train personnel involved in the development, design, implementation, operation, inspection, and enforcement of work zone related transportation management and traffic control in a manner appropriate to the job decisions each individual is required to make. Update the training periodically to reflect changing industry practices, processes, procedures, and technologies.
- Perform FHWA/PennDOT Independent Oversight Review of work zones to evaluate the effectiveness of this policy and work zone management on projects.
- Provide guidance in the development and implementation of Transportation Management Plans (TMP) on "Significant Projects".

PennDOT's Work Zone Safety and Mobility Policy includes three goals:

- Strive to keep work zone-related additional travel delays under 20 minutes when compared to the base condition.

- 10% annual reduction in work zone-related fatalities & crashes (current year vs. last 5-year running average).
- Strive to implement appropriate level TMP elements on all projects listed in Section 6.3, page 6-4, regardless of whether a formal TMP submission is required.

**Determination of Significant Projects**

All highway construction projects defined in the Section **Policy Scope** on page 6-4 shall be considered as Significant Projects unless a work zone analysis shows that added travel delays do not exceed 20 minutes for 2 consecutive hours.

Refer to **Exhibit 6-1**, **Exhibit 6-2** and **Exhibit 6-3** for more information.



Exhibit 6-1 Determination of Significant Projects - Flow Chart

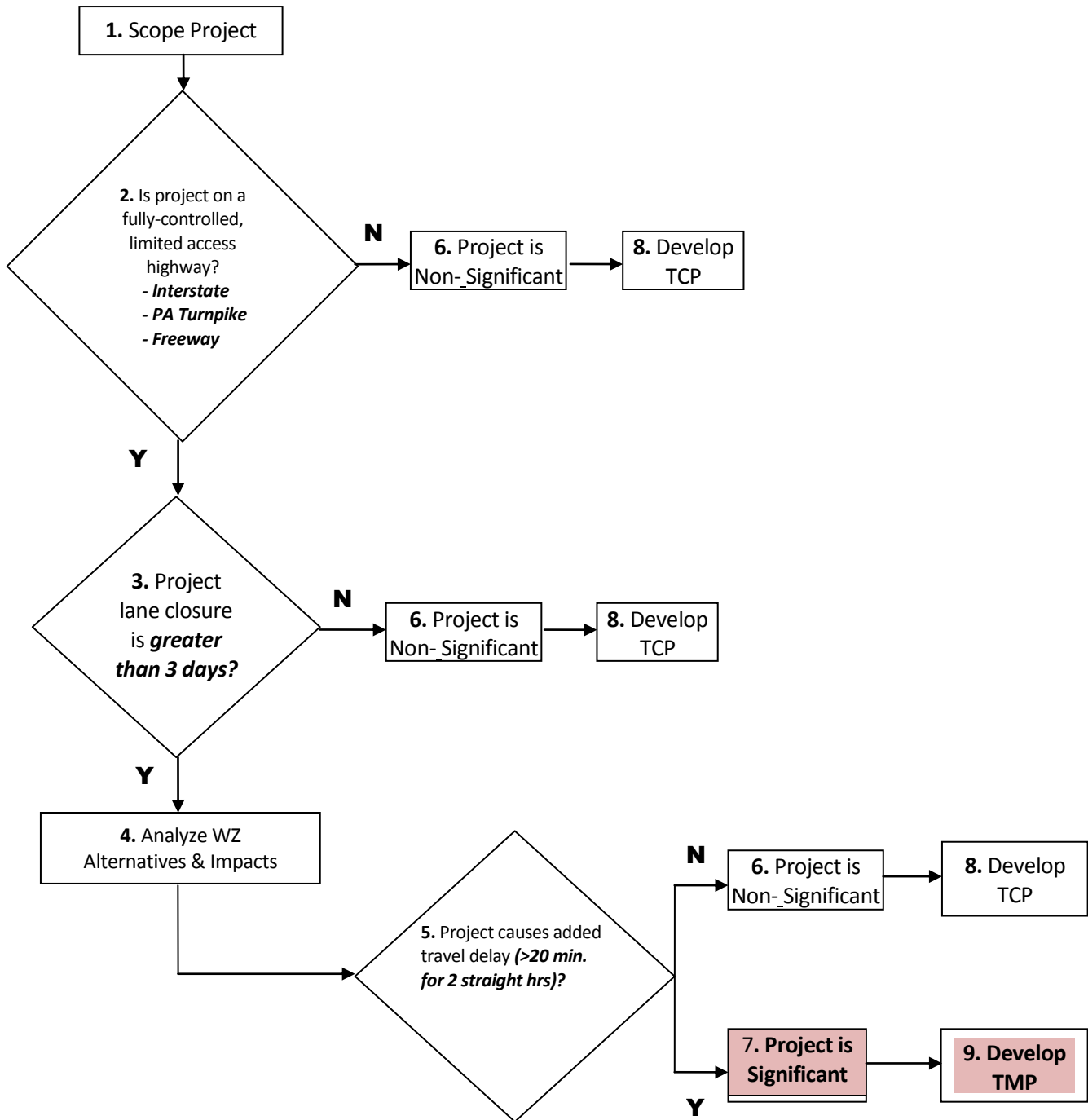

**Exhibit 6-2 Determination of Significant Projects - Flow Chart Step Descriptions**

Step	Process Title	Comments
1	Scope Project	Refer to Design Manual (DM) 1A, Chapter 5
2	Project Location	Is the project located on an interstate (including the PA Turnpike) or a freeway with fully-controlled, limited access?
3	Project lane Closures	Will the project have either intermittent or continuous lane closures (including detours) for more than 3 days?
4	WZ Alternatives Analysis & Impacts	<p><u>WZ Alternative Analysis</u> - identify <b>potential, practical (viable)</b> WZ alternative setups which fit the nature of the project and will minimize traffic impacts to motorists (could be 1 or more).</p> <ul style="list-style-type: none"> <li>Conduct WZ impacts analysis for these viable WZ alternatives as indicated below.</li> </ul> <p><u>WZ Impacts</u> - use Delay Analysis Workbook (DAWB), QuickZone, Synchro, HCS or other computer modeling programs.</p> <ul style="list-style-type: none"> <li>Note: prior analysis done for a recent similar project (<math>\leq 3</math> yrs old) may be used to estimate impacts in lieu of new model development, if project characteristics are similar (WZ setups, location, traffic volumes, grades, access, etc.); if this prior analysis &amp; impacts meets acceptable delays, there is no need for additional impact analysis.</li> </ul>
5	Traffic Delay Thresholds	<p>Acceptable Project Delay Impacts (Project is Non-Significant)</p> <ul style="list-style-type: none"> <li>Additional (project-related) travel time through the project area (includes detours) is <math>\leq 20</math> minutes.</li> </ul> <p>Unacceptable Project Delay Impacts (Project is Significant)</p> <ul style="list-style-type: none"> <li>Additional (project-related) travel time through the project area (includes detours) is <math>&gt; 20</math> minutes for time periods of 2 or more consecutive hours.</li> </ul> <p><i>Note: Added travel time shall be determined as per Step 4 (under WZ Impacts).</i></p>
6	Non-Significant Project	<p>Project does not meet policy parameters for being a Significant project</p> <ul style="list-style-type: none"> <li><u>For selected WZ approach</u>, request approval as a Non-Significant project. <b>(See Exhibit 6-3).</b> <ul style="list-style-type: none"> <li>Traffic delay analysis and preliminary project mitigation strategies (for the selected WZ approach) must be submitted &amp; approved as part of <b>the Non-Significant</b> determination process.</li> </ul> </li> </ul>
7	Significant Project	<p>Project meets policy parameters for being a Significant Project</p> <ul style="list-style-type: none"> <li><u>For selected WZ approach</u>, request approval as a Significant Project. <b>(See Exhibit 6-3).</b> <ul style="list-style-type: none"> <li>Work zone alternative analysis and preliminary project mitigation strategies (for the selected WZ approach) must be submitted &amp; approved as part of the Significant Project determination process.</li> </ul> </li> </ul>

Step	Process Title	Comments
8	Develop TCP	<p>Must develop and complete a Traffic Control Plan (TCP) for the approved WZ approach.</p> <ul style="list-style-type: none"> <li>• While a formal TMP submission isn't required, appropriate-level TMP elements need considered on these Non-Significant Projects as well.</li> <li>• Consider the development of an appropriate level TMP for the project, even though not required by policy.</li> </ul>
9	Develop TMP	<p>Must develop and complete a Transportation Management Plan (TMP) for the approved WZ approach.</p> <ul style="list-style-type: none"> <li>• Includes a Traffic Control Plan (TCP), Transportation Operations Plan (TOP) and Public Information Plan (PIP).</li> </ul>

**Exhibit 6-3 Determination of Significant Project – Submission Approval Process**

Approval Process	PennDOT Oversight (PennDOT has approval authority)	Federal Oversight (FHWA has approval authority)
Non-Significant Project Determination	<p><b>Step 6</b></p> <ul style="list-style-type: none"> <li>• <b>District Executive must approve</b> the traffic delay analysis &amp; prelim. Project mitigation strategies.</li> <li>• BOD receives a copy of the DE approval along with the delay analysis.</li> </ul>	<p><b>Step 6</b></p> <ul style="list-style-type: none"> <li>• BOD must review/concur with the traffic delay analysis &amp; prelim. Project mitigation strategies.</li> <li>• <b>FHWA must approve.</b></li> </ul>
Significant Project Determination	<p><b>Step 7</b></p> <ul style="list-style-type: none"> <li>• District Executive must review/concur with the work zone alternatives analysis &amp; prelim. project mitigation strategies.</li> <li>• <b>BOD must approve.</b></li> </ul>	<p><b>Step 7</b></p> <ul style="list-style-type: none"> <li>• BOD must review/concur with the work zone alternatives analysis &amp; prelim. project mitigation strategies</li> <li>• <b>FHWA must approve.</b></li> </ul>

**Note: Significant Projects approval submissions should include the following types of information:**

- List of alternative TCPs considered.
- Reasons for selection of preferred TCP and why thresholds can't be met.
- Documentation for submitted TCP.
  - Results of computer modeling.
  - Impacts on transportation system.
  - Impacts on community.
  - Estimated costs.
  - Any municipal official input.
- Other mitigation strategies (may be qualitatively assessed such as public information elements because delay savings could be difficult to determine).

**Applying WZSM in Project Development Process**

Engineering District offices shall address transportation management and congestion mitigation issues in all phases of project delivery from the project planning stage throughout the life of the project to improve work zone safety and mobility, refer to [Exhibit 6-4](#).

**Exhibit 6-4 WZSM in Project Development Process - Key Items**

Project Development Stage	Key Items Due
Planning	<ul style="list-style-type: none"> <li>• Potentially Significant Projects shall be identified as early in the project development process as possible so that work zone impacts may be fully evaluated, appropriate funding allocated and overall network &amp; region-wide impacts considered.</li> <li>• Districts shall work with MPOs and RPOs in the programming of projects to consider minimization of road user impacts and appropriate sequencing of projects. The cumulative impacts of multiple projects in the region’s TIP shall be considered.</li> </ul>
Scoping Field View (SFV)	<p>Preliminary considerations shall be given to potential work zone alternatives &amp; impacts and to what degree those considerations may influence the evaluation and selection of a build alternative. Additional studies and information needs shall be identified that will assist in determining whether the project is significant. Determine the status of the project as:</p> <ul style="list-style-type: none"> <li>• Non-Significant</li> <li>• Significant</li> <li>• To be determined (TBD)</li> </ul>
Preliminary Engineering	<ul style="list-style-type: none"> <li>• An analysis of work zone alternatives &amp; impacts is required prior to Design Field View, this analysis shall be conducted using prior analysis or prior documented delays for another project, QuickZone, Highway Capacity Manual/Software (HCS), Synchro, <a href="#">Delay Analysis Workbook (May 2008 Final).xls</a> or other pre-approved modeling methods.</li> </ul>
Prior to Design Field View (DFV)	<p>Make final determination of the project as:</p> <ul style="list-style-type: none"> <li>• Non-Significant</li> <li>• Significant</li> </ul> <p>Note: Approval of either the delay analysis or work zone alternatives analysis must occur prior to the DFV. Attach final approvals to ECMS project development checklist.</p>
Design Field View (DFV) Submission	<ul style="list-style-type: none"> <li>• Non-Significant Projects – provide a DFV level TCP.</li> <li>• Significant Projects – provide a draft TMP, including DFV level TCP</li> </ul>
Final Design Office Meeting (FDOM) Submission	<ul style="list-style-type: none"> <li>• Non-Significant Projects – provide a Final TCP.</li> <li>• Significant Projects – provide a Final TMP, including a Final TCP.</li> </ul>

Plans, Specifications, and Estimates (PS&E)	<ul style="list-style-type: none"> <li>• At the time the PS&amp;E is submitted to Central Office, the TMP must be attached to the Project Development Checklist in ECMS. The PS&amp;E shall include appropriate provisions for implementing the TMP. This may include:                         <ul style="list-style-type: none"> <li>○ Allowable working hours, transportation operation requirements, public information requirements, pay items, performance data collection items, special provisions, etc.</li> </ul> </li> <li>• The contract special provisions in each Significant Projects shall specify that a Work Zone Traffic Control Supervisor (or similar designation) be provided by the Contractor. This person has the primary responsibility and sufficient authority for implementing the TMP and other safety and mobility aspects of the project.</li> </ul>
Construction	<ul style="list-style-type: none"> <li>• PennDOT must designate a person trained in the fundamentals of this policy at the project level. This person will usually be the PennDOT or consultant Inspector-in-Charge.</li> <li>• Contractor must designate a Work Zone Traffic Control Supervisor (or similar designation); this person has the primary responsibility and sufficient authority for implementing the TMP and other safety and mobility aspects of the project.</li> </ul>
Conduct Performance Assessment & Process Reviews	<ul style="list-style-type: none"> <li>• Work Zone Independent Oversight Program.</li> <li>• Produce WZ Annual Report.</li> <li>• Assess performance of work zones by analyzing crash &amp; operational data.</li> <li>• Use the performance assessment to improve WZ processes &amp; procedures.</li> </ul>

**Applying WZSM in the Design-Build Process**

For projects defined in the Section **Policy Scope** on page 6-4, the Department must prepare sufficient documentation regarding anticipated temporary traffic control and project phasing so that the design-build team can develop final plans and specifications for the project. In order to carry out the requirements of the work zone safety and mobility policy on design-build projects, the Department must complete the work zone alternatives analysis (including analysis of delay impacts) prior to design field view and/or advertisement (**complete steps 1 thru 7 in Exhibit 6-2**).

The Department must provide the design-build team with enough details to allow the team to fully develop the required elements of the TMP for the project. Therefore, information such as number of lanes required, when lane closures are permitted, detour requirements, expected project completion date, and other key parameters shall be provided to the design-build team. The Department shall also identify specific contract bid items relating to maintenance and protection of traffic that the design-build team should include in the contract.

If allowed by the contract, when developing the PS&E the contractor may propose changes to the Department’s selected work zone approach; however, the contractor must analyze work zone impacts expected from their proposed alternative and receive approval from PennDOT (and FHWA as appropriate) before any changes are authorized.

PennDOT’s procedures for implementing design-build projects are found in Publication 448, Innovative Bidding Toolkit.

**Performance Measures**

Central Office will select and evaluate a group of projects that may consist of “Significant Projects” and “Non-Significant Projects”. The evaluation will measure the effectiveness of the approved work zone alternatives for each selected project. The evaluation will focus on two main areas: 1) additional project-related travel time through the project area, and 2) work zone-related fatalities & crashes.

**Additional Travel Time/Delays (Mobility):**

The objective is to evaluate additional project-related travel time (delays) through the project area, including baseline data prior to the construction being implemented. The Department’s 511PA Travel Information System (511PA) and Road Condition Reporting System (RCRS) will be used to capture the needed data and information.

- The 511PA System operates 24/7 on selected major highways. The baseline data generated for this evaluation is currently being collected and archived through 511PA. This will allow the evaluation process to incorporate information from established time periods before, during, and after construction. Any work zone project within the 511PA coverage could potentially be selected and evaluated for effectiveness.
- As projects are selected for this performance measure evaluation, Central Office will coordinate with the District Office (Traffic & Construction Unit staffs) to ensure that all traffic restrictions are documented accurately in the RCRS.
- The RCRS data indicating the actual times when the lane restrictions are placed and removed are very essential for this evaluation. Therefore, it is imperative that this information is accurately documented in RCRS by District Traffic and Construction Unit representatives.
- The data and information used to evaluate a project’s work zone safety and mobility performance will be retained electronically for future use by the Department on similar projects (scope, location, etc.).
- The evaluation findings will be shared with both FHWA and the District Offices.

**Work Zone-Related Fatalities & Crashes (Safety):**

Fatality and crash data will be collected at the project level and District level. The construction representative shall ensure that:

- A diary is kept in accordance with the Project Office Manual.
- The inspections and findings related to work zone reviews are documented.
- All crash reports are obtained and forwarded to the District Traffic Engineer.
- A complete file of inspections, crashes and correspondence related to work zones is maintained by the construction project manager. Verification of fatal and crash statistics will be cross-checked with the Department’s Crash Record System.
- This information will be available to FHWA and appropriate PennDOT personnel.

**WZSM Transportation Management Plan (TMP)**

A Transportation Management Plan (TMP) shall be developed for each Significant Project and submitted as per [Exhibit 6-4](#). A TMP lays out a set of coordinated strategies and describes how these strategies will be used to manage the approved work zone alternative of the project. The level of detail included in the TMP

will be appropriate for the size and complexity of the project. A sample TMP is discussed at the end of this section, and included in the [Chapter 6 Appendix](#) on page 6-61. A TMP shall contain the elements listed in [Exhibit 6-5](#). While a formal TMP submission isn't required for Non-Significant Projects, appropriate-level TMP elements need considered on these projects as well.

**Exhibit 6-5      TMP Elements**

Element	Requirement
1. Introduction	Cover page, table of contents, list of tables, list of abbreviations and symbols, and terminology.
2. Executive Summary	Overview of each of the TMP components.
3. Roles and Responsibilities	<ul style="list-style-type: none"> <li>• TMP (Work Zone) manager.</li> <li>• Stakeholder/review committee.</li> <li>• Approval contact(s).</li> <li>• TMP implementation task leaders (e.g., ADE Construction, Press Officer, Portfolio Manager, etc.).</li> </ul>
4. Project Description	Information such as: <ul style="list-style-type: none"> <li>• Project type.</li> <li>• Project background.</li> <li>• Project area/corridor.</li> <li>• Project goals and constraints.</li> <li>• Proposed construction phasing.</li> <li>• General schedule and timeline.</li> <li>• Related project information.</li> </ul>
5. Traffic Conditions	For the project area: <ul style="list-style-type: none"> <li>• Including data collection and modeling approach.</li> <li>• Existing roadway characteristics (history, roadway classification, number of lanes, geometrics, urban/suburban/rural).</li> <li>• Existing and historical traffic data (volumes, speed, capacity, volume/capacity, percent trucks, queue length, peak traffic hour).</li> <li>• Existing traffic operations (signal timing, traffic controls).</li> <li>• Local community and business concerns/issues.</li> <li>• Traffic growth rates (for future construction dates).</li> <li>• Prior documentation of work zone delays on similar projects.</li> </ul>

6. Work Zone Impact Assessment	<ul style="list-style-type: none"> <li>Description of only the approved WZ strategy, including the potential WZ impacts of this strategy. Note, do not reiterate the whole WZ alternatives analysis in the TMP!</li> </ul>
7. Work Zone Impact Management Strategies	For project, detour routes, corridor, region by construction phase, including TCP strategies, TOP strategies and PIP strategies. Findings and recommendations.
7a. Traffic Control Plan (TCP)	Always required for both Significant and Non-Significant Projects. <b>See Design Manual Part 3, Chapter 4.</b> A Traffic Control Plan addresses traffic flow and control through the work zone (required on all projects).
7b. Transportation Operations Plan (TOP)	The Section <a href="#">WZSM Transportation Management Plan (TMP)</a> on page <a href="#">6-12</a> addresses sustained operations and management of the work zone impact area (including impacts to adjacent roadways in the network and impacts to other traffic movements).
7c. Public Information Plan (PIP)	The Section <a href="#">WZSM Public Information Plan (PIP)</a> on page <a href="#">6-17</a> addresses communication with the public and concerned stakeholders.
8. TMP Performance	Strategies to monitor TMP performance.
9. Contingency Plans	Potential problems and corrective actions to be taken, standby equipment or personnel.
10. Break out of TMP costs	Itemized costs.

The typical responsibility for development of the Transportation Management Plan including the Traffic Control Plan (TCP), Traffic Operations Plan (TOP), and Public Information Plan (PIP) is as follows:

Project Design By	TMP Development Responsibility
Consultant	Consultant
Design-Build	Contractor *
In House	District

**\* Note: unless traffic control excluded as a design/build item.**

Contractors who propose an alternate TCP must submit a new or revised TMP including an impact analysis, TOP, and PIP.

### Sample Transportation Management Plan (TMP)

In the [Chapter 6 Appendix](#) on page [6-61](#) is a sample Transportation Management Plan (TMP) created for a project on a rural interstate highway with low traffic impacts. The level of detail included in the TMP for each project will be appropriate for the size and complexity of the project. The sample TMP was drafted using information that is readily available from other sources such as ECMS.



---

**WZSM Transportation Operations Plan (TOP)**

The Transportation Operations Plan (TOP) is a required part of the TMP on Significant Projects and is a description of the strategies that are being used to address safety and mobility. It shall be coordinated with the stakeholders (i.e., other DOTs, police, fire, emergency medical services, traffic control centers, transit, schools, etc.). The level of detail included in the TOP will be appropriate for the size and complexity of the project. A checklist of items that may be included in the TOP follows:

**Traffic Demand Mitigation Strategies**

- Transit service improvements
- Transit incentives
- Shuttle services
- Ridesharing/carpooling incentives
- Park-and-ride promotion
- HOV lanes
- Toll/congestion pricing
- Ramp metering
- Parking supply management
- Variable working hours
- Telecommuting

**Corridor/Network Management Strategies**

- Signal timing/coordination
- Temporary traffic signals
- Street/intersection improvements
- Bus turnouts
- Turn restrictions
- Parking restrictions
- Truck restrictions
- Separate truck lanes
- Reversible lanes
- Pennsylvania Late Merge
- Dynamic Late Merge
- Ramp Metering
- Suspension of ramp metering
- Ramp closures
- Street closures

- Incorporate Permanent ITS
- Railroad crossing controls
- Coordination with other construction sites
- Alternate routes

**Work Zone Safety Management Strategies**

- Work Zone speed limits
- Temporary traffic signals
- Temporary concrete barrier
- Movable barrier
- Attenuators
- Rumble strips
- Warning signs
- Automated Flagger Assistance Device
- Multidisciplinary taskforce
- QA reviews
- Dedicated traffic control supervisor
- Training
- Safety meetings
- Detour
- Alternate routes

**Traffic/Incident Management and Enforcement Strategies**

- Formal Incident Management Plan (include copy)
- ITS
- Transportation Management Center
- Aircraft
- Traffic Screens
- Call boxes
- Mile-post markers
- Service patrols
- Supplemental police assistance/enforcement
- Automated enforcement

### WZSM Public Information Plan (PIP)

The Public Information Plan is a required part of the TMP for Significant Projects. Public information is a cooperative effort with the Central Office Press Office (when necessary), the District Press Office, Community Relations Coordinator, Traffic Unit, Design Unit, and Construction Unit. The PIP shall be developed well in advance of the start date of the project, since much of the communications should be undertaken prior to start of construction. Therefore, initiation of the Public Information Plan shall begin with the scoping field view. The level of detail included in the PIP will be appropriate for the size and complexity of the project.

### Checklist for Public Information Plan

Each PIP should consist of the following elements:

1. Brief summary of project (situation analysis)
  - Project purpose and need
  - Project cost and funding source breakdown
  - Start Date
  - Completion date
  - Description of the Traffic Control Plan. Begin with conceptual plan and update as plan develops.
  - Closures and detours
    - Official detour
    - Time of day for lane drops and closures
2. List of affected stakeholders to be targeted
  - Municipalities, counties, townships, villages, MPOs/RPOs, recreational facilities, and special event sponsors
  - Local and state law enforcement
  - Emergency services
  - Affected business community
  - Schools
3. Communications plan and timeline for each part of the plan
  - Standard communications tools
  - Project-specific communications tools
  - Contact information for person responsible for each aspect
4. Milestones for updates
5. Means of evaluation of communications plan
  - In-progress
  - Post-construction

Some examples of communications tools are listed below:

- Press releases, media alerts, public service announcements
- Focus group/stakeholder meetings
- Brochures, maps
- Public involvement meetings
- Editorial board meetings
- Dedicated project web page (e.g. I-70 org)
- Changeable message board communications
- Community and group informational talks
- Local government and legislator meetings
- Dedicated phone number for information (District PIO line or other)
- Targeting tourist areas with maps and brochures (hotels, restaurants, chambers, visitor centers, etc.)
- Business letters/brochures/maps packets to major businesses affected (hospitals, colleges, large corporations)
- Business letters to any company along a ramp or route closing (Ex: SR 256 – businesses claimed they were not given enough warning)
- Dedicated am-band radio station with construction info on loop (Highway Advisory Radio – HAR)
- Billboards along affected routes
- Post “future detour” signs to allow motorists to become familiar with the route
- Regular updates to trucking companies and largest freight carriers in area

Please refer to Publication 295, Public Involvement Handbook, for further general guidance and tools that can be used in developing the PIP.

### WZSM Definitions

See [Definitions](#) on Page 6-1.

## 6.4 District Responsibilities

### District Traffic Unit

#### Field Reviews

1. In general, the District Traffic Units should have a District-wide program of inspecting work zone traffic control on construction projects, maintenance operations, and permit/utility work within the District. Nighttime inspections of work zone traffic control should be included in the program.
2. The inspection of work zone traffic control and the reporting of findings to the appropriate District unit should be a major item for the employee performing the maintenance and protection of traffic function.

**Crash Report Reviews**

1. The District Traffic Unit should review crash reports received from the Construction Unit and maintain a file of individual crash reports for each construction project. The “Construction Zone Vehicular Crash Report Form” is in Publication 2, “Project Office Manual”.
2. When a recurring crash problem arises on a project, the District Traffic Unit should inspect the work zone traffic control to see if any changes are necessary. If changes should be made, the District Traffic Unit should work with the Construction Unit to see that the changes are implemented as soon as possible. Any approved changes should be documented on the TCP, dated, and signed.

**Training**

The District Traffic Unit should, in cooperation with the District Training Coordinator, participate in the training of:

- District Construction Inspectors
- Maintenance Managers, Assistant Managers, Foremen, and all other District Maintenance employees that work on the highway
- Permit Personnel
- Survey Crews
- Bridge Inspection Teams

**Annual Report**

Each year, the Traffic Engineering and Operations Division will ask the District Traffic Units to provide District data for the Annual Report on Work Zone Traffic Control.

The report should include the following:

1. For each category (construction, maintenance, and permit/utility), provide a summary of any District Q/A reviews. Include the scores and the number of failures; the identified deficiencies and the frequency of occurrence; and what actions the District took to correct them.
2. Any new work zone policies or procedures implemented within the District. Include any District policy letters written on this subject, and the reasons for implementing these policies and procedures.
3. Any recommendations to revise Department standards, practices, policies and procedures.
4. District “best practices” that you would recommend on a statewide basis.
5. The positive or negative results of novel or innovative traffic control.
6. A listing and description of all training efforts that were conducted by the District and counties for Department or outside personnel. Use the following general format:

Date	Duration (hrs.)	Number Trained	Agency Trained	Audience	Topic/ Subject
2/2/07	2.5	24	PennDOT	Foremen	Flagging
6/21/07	4	10	Nat'l Fuel Company	Supervisors	Work Zone

7. Problems with permit/utility operations and related activities, and any recommendations for improvement.
8. ITS deployment in construction work zones. Include the location (project, county, SR, segment) and type of ITS (queue detection, motorist information/travel time and delay, variable speed limits, etc.).
9. Suggestions for needed research on either the State or National level.
10. Any other information that may be of interest to the other Engineering Districts, Counties, Central Office or FHWA.

**District Construction Unit**

The Construction Unit is directly responsible for the administration of Department construction projects including the implementation of the TCP, routine inspection of work zone traffic control setups and devices.

Through routine inspection of work zone traffic control setups and devices, field inspectors will use a standardized form (Maintenance and Protection of Traffic Inspection Checklist – CS-901 form) to record whether or not all temporary traffic control devices are either compliant or deficient as per the criteria in Publication 408, Section 901.3(v). The standardized form will also show the dates and approximate times when the contractor was notified of the deficiency and when the deficiencies were corrected. The form can be used for documentation to assess Work Zone Liquidated Damages (as described within Sections 901.3(t) and 105.01(b) of Publication 408). The standard form is available at the following location <ftp://ftp.dot.state.pa.us/public/PubsForms/Forms/CS-901.pdf>.

The Construction Unit is also responsible to collect crash data on construction projects since this information is a valuable aid in reducing future work area crashes. Therefore, the following procedures are established:

- a) The Construction Unit should send a letter to the State Police station or to local police advising them of each upcoming project and asking them to call the inspector-in-charge whenever a traffic crash has occurred within the specified limits of the construction project.
- b) When the State Police or local police call to notify the inspector-in-charge of the occurrence of a construction zone crash, the inspector should complete a copy of the “Construction Zone Vehicular Crash Report Form” which is available in Publication 2, “Project Office Manual”. The use of this form should provide all pertinent information. The inspector-in-charge should also request a copy of the police report.
- c) The inspector-in-charge should provide a copy of the completed “Construction Zone Vehicular Accident Report Form” and any police reports to the Assistant District Executive-Construction and the District Traffic Unit.
- d) After receiving each accident report, the Project Engineer should inspect the work zone to determine if changes or revisions are necessary. However, the Project Engineer should not change

the TCP until they receive approvals from the District Traffic Unit. The Project Engineer should document and date all changes or revisions made because of a crash.

- e) Maintain all individual crash reports and project crash analysis in the project file.

## 6.5 Quality Assurance

### Independent Oversight Program (IOP) with FHWA

- a) To ensure Quality Management in producing superior products and services, the PennDOT/FHWA Stewardship and Oversight Agreement calls for an Independent Oversight Program (IOP) to perform selective reviews of PennDOT processes. As a result, a team including a representative from PennDOT's Central Office Work Zone Section, Construction Quality Review Section, and FHWA will jointly conduct work zone IOP reviews on construction projects, one-third of the Engineering Districts every other year. (Maintenance operations will not be a part of these reviews.)
- b) These reviews will include District policies, procedures, and field reviews of work zones. The team will use PennDOT's existing QA forms or a similar document for work zone traffic control field reviews. The team will give the District Work Zone Manager one week notice prior to the start of the IOP review. If possible, the Work Zone Manager or another representative from the District Traffic Unit should accompany the team during the review (a representative of the District's Construction Unit may also accompany the team).
- c) On the first day, the review team will meet with the Work Zone Manager to discuss the scope of the review and go over District policies. After completing the field reviews, the team will conduct a closeout conference with the Assistant District Executive for Construction or their representative to discuss the findings. A formal report will be written and submitted at a later date by FHWA.

### Other Quality Assurance Reviews

In addition to the quality assurance reviews conducted by the Central Office Review Team, additional QA reviews are as follows:

- Construction projects — Bureau of Construction and Materials, Quality Assurance Division.
- Maintenance projects — Bureau of Maintenance and Operations, Quality Assurance Review field personnel (part of the accreditation process).
- Permit/utility projects — District Maintenance Offices, Permit Section.

The Engineering and Maintenance Districts should also conduct work zone QA reviews on construction, maintenance, and permit/utility operations.

### Quality Assurance Review Form

The Quality Assurance Review form is a general comprehensive checklist used for construction projects, but may be used on any type of operation. The Quality Assurance Review form and database use by the Central Office Review Team are available at the following locations:

- Form – [P:\bhste\\_shared\workzones\QA Database\QA Blank Short Form.doc](P:\bhste_shared\workzones\QA Database\QA Blank Short Form.doc)
- Database – [P:\bhste\\_shared\workzones\QA Database\QA State Wide Database.mdb](P:\bhste_shared\workzones\QA Database\QA State Wide Database.mdb)

## 6.6 Traffic Signs

### General

#### Fluorescent Orange Sheeting Materials

Refer to Bulletin 15 for information on fluorescent sheeting. The website for the Bulletin is ([ftp://ftp.dot.state.pa.us/public/pdf/bocm\\_mtd\\_lab/publications/pub\\_35/bulletin\\_15.pdf](ftp://ftp.dot.state.pa.us/public/pdf/bocm_mtd_lab/publications/pub_35/bulletin_15.pdf)).

#### Breakaway and Yielding Sign Supports

Department guidelines for breakaway and yielding sign installations are contained in Publication 111. Approved Type B sign supports are listed in Publication 35.

In Publication 111, review the TC-8700 Series drawings which apply to the small sign supports normally used for post-mounted work zone signs.

#### Department Maintenance Operations

- a) All maintenance operations involving moving short-term operations on divided highways, one-way highways, or two or more lane approaches of undivided highways, where the operation moves intermittently or continuously at an average speed of more than 1 mph (88 feet/minute), shall consider establishing a reduced "Work Zone Speed Limit" in accordance with Chapter 212 and Publication 213.
- b) All maintenance operations on multi-lane, high-speed highways using work zone traffic control, in accordance with Publication 213, may install work zone speed limit signs reducing the work zone speed limit 10 mph. This reduced speed limit should not be installed for the entire length of the work area if work is confined to only a portion of the total area at any one time. The reduced speed limit should only cover the area approaching and the area through which work is actually in progress.
- c) When a maintenance operation implements a work zone speed limit, the first work zone speed limit sign must be installed approximately 500 to 1,000 feet in advance of the work area in order to give drivers time to slow down before entering the work area. The first work zone speed limit sign must be installed on the right side of the roadway (both sides of the roadway on multilane facilities), and if the reduced speed limit extends more than one-half mile, additional work zone speed limit signs must be installed. (The Vehicle Code mandates that speed limit signs for speed limits less than 55 mph be installed at intervals not greater than one-half mile.) For the reduced speed limit to be legal all conflicting speed limit signs must be covered and an "End Work Area" sign must be installed beyond the work area. In order to provide a greater target value to the work zone speed limit signs, orange flags may be installed with the signs in the same manner as with warning signs.

#### Drone Radar

Drone radar should be considered at the beginning of the confined lanes and at approximate 2-mile intervals. Drone radar may also be added to moving construction vehicles since this seems to be very effective.



## Act 229 Signs

On December 23, 2002, Act 229 modified the Vehicle Code to improve safety in work zones (including but not limited to adding §§1378, 4309 and 6123.1, and modifying §§102, 1373, 1535, 3326, 3365, 3368, 3372 and 6123). Initially, the Department developed very broad guidelines as intended by the legislation, but with the approval of the legislative architects, eventually reduced the scope to apply only for long-term, high-speed projects.

Specific elements of Act 229 include:

1. Installation of signs to have drivers turn on their headlights in “active work areas” (a legal opinion indicates that daytime running lights are acceptable).
2. Need for speed display signs on larger Interstate construction projects.
3. Department to withhold \$1,000 from contractors for each day that they are in non-compliance with contract safety provisions.
4. A 15-day suspension of operating privileges for drivers committing violations in an active work zone.
5. Stronger suspension of motor carrier vehicle registrations for safety problems.
6. Emphasize good management principles, i.e., keep work zones as short as practical, minimize lane restrictions, and remove traffic control devices as soon as possible.

Department regulations relative to Act 229 are in 67 Pa. Code §212.419 (relating to special controls in work zones), and a copy is included herein in the [Chapter 6 Appendix](#) on page [6-72](#).

## Temporary Business Signs in Work Zones

When a highway or street is under construction, or when a detour is established forcing motorists onto different routes, temporary business signs should be installed to guide motorists to the affected businesses. Do not automatically assume that the locations of the business, office complex, shopping center, or their entrances are intuitively obvious. The general rule is to sign for elderly drivers who are not familiar with the area.

- a) Criteria.
  1. Road closed with detour established.
  2. Install signs for major shopping centers, offices, industrial sites and general street locations (e.g., Locust Street businesses) with directional arrows in advance of locations where a left or right turn is required to direct drivers along the proper route to the location. Sign individual businesses if there is a possibility of a problem in locating them. A “ROAD OPEN TO \_\_\_\_\_” sign may also be necessary.
  3. Road closed but traversable.
  4. Install sign at the road closure saying “Road Open to \_\_\_\_\_,” using the name of the furthest office complex, shopping district, plaza or mall, street, or geographic location.
  5. Road under construction.
  6. If the access to a business is changed, moved, or not easily identified, then place a sign with the business name, as needed, and a directional arrow at the business entrance.
  7. Use other appropriate sign schemes to fit unique conditions.

b) Due to the numerous variables involved (type of business or office, number of businesses, length of words in the business name, number of locations, etc.), it is not possible to specify a single sign standard that would be correct for every signing situation, but the following general guidelines are offered.

1. Use black legend on an orange background. Do not install business logos.
2. Whenever possible, use 6-inch legend on 72-inch wide sign panels on multilane roadways and on all roadways where the assumed travel speed is 40 mph or higher.
3. Show the business sign layouts and locations on the Traffic Control Plan.

c) Cost/Installation

Sign costs and installation are to be included as part of the construction project, businesses are not to be charged. A separate pay item should be established on a square foot basis.

### Winter Shutdown

During the fall, construction projects that will be continuing into the next year begin shutting down for the winter. To maintain our work zone credibility, all signs (including work zone speed limit signs) and channelizing devices are to be removed or covered, except if the unfinished project poses a hazard to motorists.

### Portable Dynamic Message Signs

Dynamic message signs (DMSs) can be effective on high-speed highways by furnishing drivers with real time information of problems and unexpected conditions, and telling them the best course of action. DMSs can be particularly useful at highway construction and maintenance work sites that frequently present drivers with unexpected traffic or detour situations.

Their primary purpose in work zones should be to advise drivers of unexpected traffic and routing conditions; however, repeat drivers become accustomed to the situation and may not read the message. Therefore, consider changing the message slightly to help keep the drivers' attention.

When using DMSs, take care to be sure that the messages are correct and displayed at the proper time. Drivers will normally have a negative attitude about the sign if it:

- Displays information that is contrary to existing conditions
- Displays information that is not easily understood or read in ample time to make the appropriate maneuvers.
- Tells drivers something they already know.

When using multiple signs to convey information, maintain 1,000 feet between signs. The message must be short enough so that an approaching driver can read the entire message. The message must be displayed long enough so that the message is readable at the travel speed of the highway. Normally, a driver needs at least one second per short word (up to eight characters) and two seconds per unit. A 12-inch message is normally readable from approximately 450 feet and an 18-inch message from approximately 650 feet. Consider placement on both left and right side of roadway for freeways and interstates.

### Advance Notice of Pending Work

Districts should consider using portable dynamic message signs (DMS) or the ROAD WORK TO BEGIN NEXT WEEK (G20-1-2) signs to advise motorists of future lane closures on freeways, expressways, and other high-volume highways. Use W23-1 signs on structures. Use these signs during the week before a maintenance activity begins to alert motorists of the upcoming project. The G20-1-2 sign may be on a Type III barricade or a portable sign support.

If a DMS is used, Districts are encouraged to use them throughout the duration of the activity as a supplemental warning device.

## 6.7 Pavement Markings and Delineation

### General

In accordance with 67 Pa. Code §212.407 (relating to markings for temporary traffic control), when lane line and centerline pavement markings on more than 250 linear feet of highway are covered or destroyed by construction, maintenance, utility, permit, or other work, the lines must be replaced before terminating work each day. The replacement markings may be standard pavement markings or temporary markings as included in Section 901.3(k) of Publication 408 (Work Area Pavement Markings) or in Section 6F.78 of the *MUTCD* (regarding temporary pavement markings).

### Compliance by Engineering Districts

- a) Replace centerlines and lane lines that were covered or destroyed as a result of the work operation with standard pavement marking patterns or pavement marking patterns meeting the requirements shown in the TC-8600 Standard prior to terminating work each day, except that:
  - Markings are not required if the surface texture of the roadway prohibits the installation of markings (consider no pavement marking signs). In this case, install pavement markings as soon as practical.
  - Consider temporary edge lines for high-speed, high ADT locations.
- b) Replace edge lines when the roadway is scheduled for final painting. Schedule school zone markings, railroad markings, stop lines, and any other markings required along the roadway as soon as possible after installing the edge lines.
- c) In order to comply with the new FHWA requirements for “short-term” pavement markings in work zones, each Engineering District should require the contractor to install all required pavement markings, including “short-term” and/or standard pavement marking patterns on all construction projects including Purchase Order Contracts.
- d) For the installation of required pavement markings on Department Force projects, the Engineering and/or Maintenance District may select one or more of the following methods or may select another method not listed below:
  1. Schedule the work in each county so that the required “short-term” and permanent pavement markings required in the TC-8600 Standard may be installed with the District’s large truck-mounted paint machines and/or small paint machines.
  2. Use approved temporary pavement marking tape for all required “short-term” pavement markings, or install standard pavement markings using approved cold plastic or other

approved durable materials. These options are especially viable if a county only does short sections of motor paving or skin patching.

3. Purchase a small truck-mounted paint machine (pick-up truck size) with a two-color system that can paint a double line, paint on the left and right side at the same time, use heated paint for rapid drying, and dispense beads onto the painted line. Rotate the truck throughout the District by having the counties schedule all of their resurfacing, motor paving, skin patching, and seal coating projects during the time they will have the truck-mounted paint machine. The Engineering District could assign personnel to this truck at their discretion, and could possibly use the equipment to help complete their small paint machine work.
4. The District or County could investigate the possibility of using contract painting.

### **Pavement Markings in Work Zones**

This should clarify several issues associated with the Department's policy on pavement markings used in work zones.

- a) Refer to Publication 408, Sections 901.3(k) and 962.
- b) It is permissible to use any approved temporary non-removable pavement marking tape in lieu of paint.

### **Delineation of Temporary Concrete Median Barriers**

To improve visibility of the barrier, Districts shall provide delineation of the barrier and a temporary edge line.

Conform to the TC-8604 Standards, except that barrier-mounted delineation may be installed at 20-foot spacing within transitions and curves.

Edge lines should be any of the following:

1. Install temporary pavement marking tape or paint on the roadway at a distance of 6 inches or more from the base of the barrier.
2. Apply an edge line (paint and glass beads, or temporary pavement marking tape) on the lower sloping surface of the barrier instead of on the road surface. Before applying the line, the barrier must be thoroughly cleaned by high-pressure water blasting. Moreover, because traffic does not wash the line by running on it, add a special provision to require the contractor to clean the edge line with high-pressure water as directed by the Department.
3. Attach temporary RPMs to the road surface at a minimum distance of 6 inches from the base of the barrier, and at a 40-foot spacing within transitions and curves, and at a 80-foot spacing on tangent sections.

The advantage of the last two types of "edge lines" is that these methods eliminate the need to eradicate the edge line, thereby reducing costs and eliminating eradication scars.

### **Temporary Shadow Lines**

All "shadow lines" shall maintain a minimum retroreflectivity of 125 mcd/m<sup>2</sup>/lux.

Some Districts have installed temporary pavement markings using half the normal application thickness for paint and glass beads.

These 7- or 8-mil thick temporary “shadow lines” generally allows the final durable marking to mechanically bond with concrete or asphalt road surfaces, thereby eliminating the need for costly surface preparation or pavement marking removal. Conversely, when using a full thickness (12 or 15 mils) temporary line, the final durable markings will not bond properly with the roadway surface and removal of the temporary lines is required.

Shadow lines installed prior to the installation of final durable markings must meet a minimum retroreflectivity of 125 mcd/m<sup>2</sup>/lux. The procedure is as follows:

1. Allow the contractor to apply a thinner temporary line that still provides the required minimum retroreflectivity for the duration of the construction phase and may not require eradication before the final markings are applied.
2. The contractor will conduct and document initial and weekly retroreflectivity measurements of the temporary lines to guarantee that the minimum retroreflectivity requirements are being met to ensure that FHWA will participate in the funding of the pavement marking items. If they are below the minimum requirements, the contractor is responsible to repaint to bring them up to required levels.
3. The contractor is responsible for corrective action should the permanent markings fail to adhere to the temporary markings and/or not meet the required retroreflectivity for a period of 6 months following placement.

## 6.8 Traffic Signals

### Traffic Control Signals

Refer to Publication 213 for typical application drawings and appendix for temporary signal requirements, application, and permit.

## 6.9 Barriers, Drums and Fences

### Temporary Concrete Barrier Types

This section provides policy and guidance for using appropriate temporary concrete barriers as part of the work zone setup. If temporary concrete barriers are used, it is important to follow the following guidelines.

The temporary concrete barriers available for use are as follows:

- a) NCHRP 350 or ASSHTO *Manual for Assessing Safety Hardware* (MASH) approved barriers:
  1. Use the PennDOT standard F-Shape concrete median barrier in accordance with the current RC-Standards.
  2. Other approved NCHRP 350 or MASH barriers may be used in work zones as appropriate provided they are crash tested and approved by the FHWA and PennDOT.
- b) All new temporary concrete barriers purchased by the Department or contractors must be NCHRP 350 or MASH approved.

See the Section [Enhanced Worker Protection](#) on page [6-38](#) for other guidance on usage.

## Drums

Under normal conditions, all channelizing devices listed in Section 901 of Publication 35 are considered equally effective in guiding motorists through the work area and around obstacles. If the Districts direct the use of drums (or the use of some other specific type of channelizing device), it should be specified in the special provision. In addition, a clear and sufficient reason for specifying the specific type of channelizing device should be documented in writing and kept in the project file.

## Reflective Plastic Safety Fence

Reflective plastic safety fence currently does not require a Certificate of Approval for use in work areas. This fence comes in several colors; however, only orange may be used in construction areas within the Commonwealth.

## Non-Conforming Traffic Control Devices

The use of non-conforming devices requires permission to experiment from the FHWA. This may be obtained by submitting a Request for Permission to Experiment in accordance with the MUTCD. The Bureau of Maintenance and Operations (BOMO) will coordinate these requests.

## Certification of Compliance – Materials and Products

Contractors must use Form CS-201, Source of Supply-Traffic Items (available in ECMS) to summarize the specific types of traffic control devices used on a project.

## 6.10 Arrow Panels and Warning Lights

### Arrow Panels

#### Display

- a) Approved arrow panels, listed in Publication 35, Section 901, are required, as a minimum, to display each of the following messages:
  1. Left flashing arrow.
  2. Right flashing arrow.
  3. Simultaneous left and right flashing arrows (flashing double arrow).
  4. A caution mode consisting of four or more lamps arranged in a rectangular pattern, or horizontal pattern of four or more lamps in a straight line or “bar” that will not indicate a direction.
- b) Some arrow panels will also display a left or right sequential arrow or sequential stem mode. The use of the sequential arrow and sequential stem message modes should not be used for the following reasons:
  1. An FHWA sponsored research study found that drivers clearly prefer the flashing arrow and sequential chevron modes, and these modes were generally superior to the sequential arrow and sequential stem modes in promoting lane changing and driver understanding.
  2. The sequential arrow and stem must go through four pulses as opposed to two pulses for the flashing arrow.

3. The arrowhead in the sequential stem mode only appears during the third pulse.
- c) Only use the flashing arrow mode for a lane closure on multilane roadways. The caution mode may be used for shoulder work or for temporarily closing one lane of a two-lane roadway.

### Dimming

The Department's specification for arrow panels requires that all arrow panels have an automatic dimming circuit actuated by a photocell at a light level of approximately 5 foot-candles to provide a minimum of 50 percent dimming from the rated lamp voltage. If this dimming does not take place, arrow panels are much too bright during hours of darkness. Periodically inspect all Department-owned arrow panels to verify that the photocell and dimming circuit are operating properly. Also, make periodic checks of all arrow panels used on construction projects to determine if the proper dimming takes place during hours of darkness. If problems occur, notify the contractor and require that the necessary repairs be made.

### Placement

Arrow panels should generally be located as shown in the typical applications in Publication 213; however, this location should be field adjusted to optimize visibility of the device. Each District should require all Department users of arrow panels to become familiar with Section 6F.56 of the *MUTCD* and all of the drawings relating to arrow panels in Publication 213. Project Managers on construction projects should review all arrow panels to determine if arrow panels are properly located.

### Warning Lights

#### Application of Flashing Warning Lights, Types A and B

- a) Flashing warning lights may be used to call drivers' attention to signs, obstructions, or potential hazards.
- b) Flashing warning lights may be used to mark obstructions or potential hazards. They are not permitted to be used for delineation since a series of flashers would tend to obscure the desired vehicle path. Flashing warning lights are not permitted to be used in a series unless the spacing between successive flashers is at least 250 feet.
- c) Two-way Type A lights are not permitted to be used where they would be visible and confusing to drivers in other directions of travel.
- d) Type A and B lights shall be mounted on signs in accordance with the *MUTCD*. When used, the lights shall have a minimum mounting height of 30 inches to the bottom of the lens, and they shall be mounted at or above the midpoint of the sign face without obscuring any part of the sign face. When a Type A or B light is mounted on a STOP (R1-1) sign, the color of the light shall be red.

#### Application of Steady Burn Lights, Type C

- a) Type C lights may be used to delineate the proper vehicle travel path through a work zone. They may be mounted on barricades, drums, vertical panels, barriers, or other supports. See [Exhibit 6-6](#).
- b) Type C lights may be used when a series of lights is required.
- c) Two-way Type C lights are not to be used where they would be visible and confusing to drivers traveling in the opposite direction to that of which the lights are meant to serve.

Exhibit 6-6 Use of Type C Lights Through Work Zone

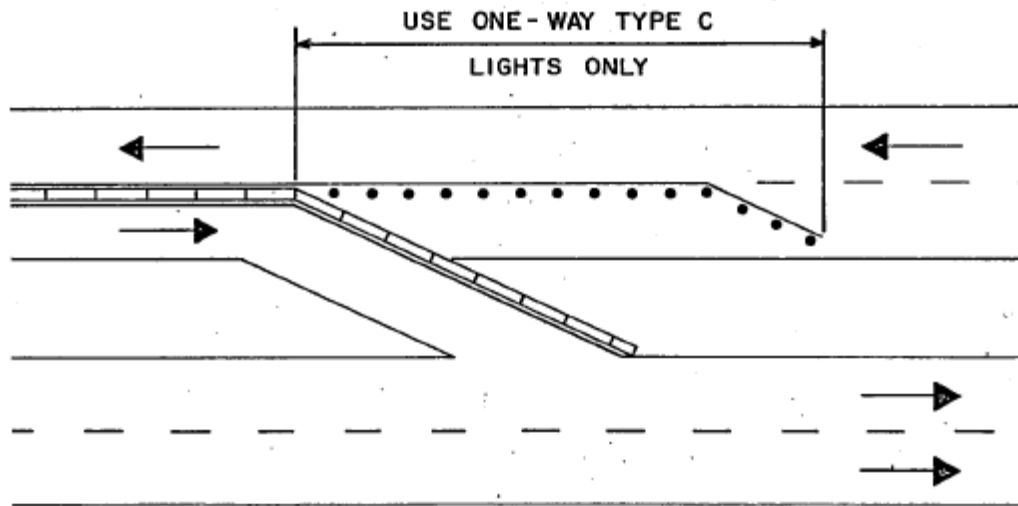

**Flashing Warning Lights on Type III Barricades**

- a) When using a flashing warning light in conjunction with a barricade, TC 8716 requires the Type B light assembly to be attached to the sign, but the battery case must rest on the pavement surface and be fastened to a vertical leg. The distance between the top of the battery case and the pavement surface shall not exceed 20 inches.

**6.11 Shadow Vehicles and Impact Attenuators**

**Shadow Vehicle(s) Required**

General Pennsylvania Statewide Policy (from Publication 213). This applies to all entities (included, but not limited to contractors, utilities, municipalities, etc.) performing roadwork in Pennsylvania. As shown in the PATA drawings of Publication 213, shadow vehicles are required with a Truck Mounted Attenuator (TMA) on all freeways and expressways, but are optional on other facilities as noted in the specific PATA drawings.

Specific Policy for PennDOT Maintenance. Use shadow vehicle(s) in the following short-term maintenance work areas:

- a) On freeways and expressways. Use a shadow vehicle for all full-lane or partial-lane closures and for all work on the shoulder. If the shoulder is not wide enough to safely park the shadow vehicle, then the adjacent lane should be closed.
- b) On other roadways. The use of a shadow vehicle is optional as stated in Publication 213.

**Occupancy of Shadow Vehicles**

- a) When protecting a stationary or stop-and-go operation where the operation will be stopped for an estimated 5 minutes or more, turn the ignition off, set the emergency brake, put the transmission in reverse, and turn the front wheels to the right. However, when the shadow vehicle is in the extreme left lane or left shoulder where a minimum 30-foot wide median exists, then turn the front wheels to the left.



Moreover, the shadow vehicle shall be unoccupied. The operator of the shadow vehicle shall not remain in the vicinity of the stationary shadow vehicle but shall assist the work crew or function as a watcher as assigned by the foreman.

- b) When protecting a continuous moving or stop-and-go operation where the operations will be stopped for less than 5 minutes, the driver of the shadow vehicle shall be the only occupant in the vehicle.

**Posting of Shadow Vehicle(s)**

- a) In general, all shadow vehicles that are not behind other work area protection devices should be visible from behind for a distance, in feet, of ten times the legal speed limit.
- b) When only one shadow vehicle is used, it shall be located behind the work area at an approximate distance of 100 to 250 feet.
- c) When two shadow vehicles are used, except for stationary short-term operations in a “two-way, left-turn lane, (i.e., except for PATA 15 in Publication 213), the first shadow vehicle shall be located as in (b) above and the second shadow vehicle shall be located completely on the shoulder and a minimum distance upstream from the first shadow vehicle as follows:

- 1. All freeways and expressways: 1,000 feet.

- 2. All other highways:

25 mph	250 feet
30 mph	300 feet
35 mph	350 feet
40 mph	400 feet
45 mph	450 feet
50 mph	500 feet
55 mph	550 feet

- d) When two shadow vehicles are required on short-term stationary operations in a “center-two-way-left-turn-lane” (PATA 15 in Publication 213), one shadow vehicle shall be located on each side of the work area at an approximate distance of 100 to 250 feet. (NOTE: If wheels are turned on the shadow vehicles in this scenario, the wheels should be turned to the right.)
- e) All shadow vehicles shall be positioned so that the back of the vehicle is facing oncoming traffic.

**Size, Weight, and Equipment for Shadow Vehicles**

When used with a truck-mounted attenuator (TMA), the size and weight of the vehicle should be in conformance with the TMA manufacturer’s specifications.

**Impact Attenuator System Design**

- a) Publication 35 lists approved attenuator systems.
- b) The individual design of attenuators shall be in accordance with the information in the Design Manual, Part 2, and with the manufacturer’s catalogs and recommendations.

- c) The nose of all impact attenuators used in construction projects shall have delineation in accordance with RC-57M Standard drawings. If using sand barrels for attenuation, use the layouts as displayed in the [Chapter 6 Appendix](#) on page 6-74.

## 6.12 Workers' Attire

### Required Attire

#### MUTCD Section 6D.03

- All workers within the right-of-way exposed either to traffic, or to work vehicles and construction equipment within the TTC zone shall wear high-visibility safety apparel.
- *Worker* - a person on foot whose duties place him or her within the right-of-way of a street, highway, or pathway, such as street, highway, or pathway construction and maintenance forces, survey crews, utility crews, responders to incidents within the street, highway, or pathway right-of-way, and law enforcement personnel when directing traffic, investigating crashes, and handling lane closures, obstructed roadways, and disasters within the right-of-way of a street, highway, or pathway.
- Responders to incidents and law enforcement personnel may wear a "Public Safety Vest" within the highway right-of-way

Emergency and incident responders personnel may wear high visibility safety apparel that meets the performance requirements of the ANSI/ISEA 207-2006 publication 6 entitled "American National Standard for High-Visibility Public Safety Vests" or equivalent revisions.

High-visibility safety apparel that is intended to provide conspicuity during both daytime and nighttime usage, and that meets the Performance Class 2 or 3 requirements of the ANSI/ISEA 107-2004 publication entitled "American National Standard for High-Visibility Safety Apparel and Headwear" or equivalent revisions.

#### Department Employees

- a) All Employees shall follow the current version of the Department's Safety Policy Manual (Publication 445).

### Ordering High Visibility Garments

- a) High visibility pants and leggings are available through the PIBH. These garments are made with the same lightweight (2.3 oz) material as used in the vests. There are two horizontal retroreflective stripes on each pant leg or legging. Use of these garments will increase visibility of the wearer both day and night due to the continual movement of an employee's legs while walking/working.
- b) High visibility leggings were developed as an option due to comfort concerns. The leggings slip on the lower leg between the knee and ankle. High visibility pants are loose fitting and should be slipped over the employee's regular pants. In no case should these garments be substituted as regular pants the employees wear to work on a daily basis.
- c) Questions regarding high visibility clothing should be forwarded to the Employee Safety Division.

The above information is also included in Publication 445.

### Reflective Tape on Hard Hats

Department employees may place one-inch wide strips of silver-colored reflective tape on their hard hats since this may improve the visibility of workers during hours of darkness. This is also referenced in Publication 445.

## 6.13 Specialized Operations

### Counter Installation

#### General

This is the Safety and Work Zone Traffic Control Policy for the installation, maintenance, repair, or removal of traffic counting equipment for the purpose of recording traffic volumes, classification, and weight. While this policy encompasses most situations encountered during the installation, maintenance, repair, or removal of traffic counting equipment and is intended to highlight and clarify key safety and work zone issues, it is ultimately the responsibility of those engaged in this activity to comply with the policy set forth in the appropriate regulations and publications.

This policy applies to all Department personnel, Metropolitan Planning Organizations (MPOs), Regional Planning Organizations (RPO), contracted vendors and others engaged in the installation, maintenance, repair, or removal of traffic counting equipment on highways within the Commonwealth.

#### Vehicle

The vehicle(s) used during the installation, maintenance, repair, or removal of traffic counting equipment shall be equipped with either a flashing or revolving yellow strobe light or a bar of lights. The light or bar of lights shall be at a location on the vehicle where it is visible by approaching traffic from all directions (see 67 Pa. Code, Chapter 173, "Flashing or Revolving Lights on Emergency and Authorized Vehicles").

#### Personal Protection Equipment and Attire

All Employees shall follow the current version of the Department's Safety Policy Manual (Publication 445).

#### Work Zone Safety and Signing

Most activities performed during the installation and removal of portable traffic counters, and the installation, maintenance, or repair of permanent traffic counting facilities are short-term operations. Therefore, employees shall comply with Publication 213.

- a) Portable Counter Installation/Removal. Since the installation and removal of portable traffic counters normally takes less than 60 minutes, if applicable, refer to notes on the figures in Publication 213 to eliminate the signs and channelizing devices. The vehicle and traffic counting personnel shall be seen by approaching traffic for a distance, in feet, equal to ten times the posted speed limit. In addition, if the counting equipment cannot be safely installed due to a narrow shoulder, insufficient sight distance, heavy traffic volumes, or any other unsafe condition, use a flagger or a uniformed police officer to assist the traffic-counter personnel. If this assistance is not available, do not attempt to set the counter. Notify the immediate supervisor.
- b) Permanent Traffic Counting Facility Installation/Maintenance/Repair. Permanent traffic counter facilities may include, but are not limited to, Automatic Traffic Recorder (ATR), Continuous Automatic Vehicle Classifier (CAVC), or Weigh-in-Motion (WIM) sites. Use figures from Publication 213 to establish work zone traffic control during the installation, maintenance, or repair of

permanent traffic counting equipment and site components located adjacent to the roadway. Any operation that blocks a portion of the travel lane must comply with Department of Transportation Regulation, 67 Pa. Code, Chapter 212, "Official Traffic Control Devices."

- c) Signing. When warning signs are required, consider using a COUNTER INSTALLATION AHEAD (W21-15) sign instead of the ROAD WORK AHEAD (W20-1) sign.

### Additional Safety Precautions

The work performed by personnel during the installation, maintenance, repair, or removal of traffic counting equipment demands a heightened sense of alertness due to exposure to passing motorists. It is for these reasons that everyone is required to adhere to this policy and observe all possible safety precautions to prevent injury to one's self and to prevent hazardous conditions for the motoring public.

- a) Carefully plan the location of traffic counters — use routes that restrict numerous directional changes. A tangent section of highway is best for setting traffic counters. This allows for additional sight distance and helps to ensure the longevity of road tube by avoiding hard steering or braking traffic.
- b) Pull the support vehicle(s) onto the shoulder and turn on the four-way flashers, flashing, or revolving yellow strobe light or light bar, and headlights to give additional warning to approaching motorists.
- c) Wear personal protective equipment, including a hard hat, safety goggles/glasses, gloves, and a high visibility safety vest as required.
- d) Allow enough time to travel between counter locations. Look for a stable (but not too hard) surface to strike nails or spikes into and be careful to strike the center of the nail head or spike to avoid ricochet. Carefully secure the "dead end" of the road tube far enough away from the path of travel to reduce the possibility of injury by a passing vehicle.
- e) Wait until all cars in a row have passed and there is no sound of approaching traffic. Allow enough time to set counters safely and be sure to have enough "slack" in hand before starting across the highway. Tie off and secure the road tube to avoid having the road tube and nails pulled up by traffic.
- f) Avoid setting traffic counters in areas of tall grass where ticks and other flying insects may be harboring. Wear a good pair of hiking shoes, long sleeve shirt, and durable jeans that protect the legs.
- g) Drive defensively. Other drivers are often impatient as you turn or slow down to set up the counters. Use turn signals, mirrors, and avoid backing up whenever possible. Be aware that the typical van creates blind spots to the rear and to the side.
- h) If an accident or injury should occur, immediately report it to the supervisor.
- i) Do not attempt to set a counter in an obviously dangerous area — look for a safer location. If this is not possible, do not attempt to set the counter, but inform the supervisor of the problem.

### PennDOT Traffic Counter Training

All persons that will be engaged in installing and removing portable traffic counters shall view PennDOT's Traffic Counter Training video, which includes safety and installation/removal best practices. The PennDOT Traffic Counter Training video is available on the Bureau of Planning and Research's internet "Traffic Partners Page" at: <http://www.dot.state.pa.us/Internet/bureaus/pdPlanRes.nsf/infoBPRvideochoice>.

Copies of PennDOT's Traffic Counter Training video are also available on compact disc from the Bureau of Planning and Research by calling 717-787-5796.

## Backing Up or Driving in a Counter-Flow Direction

### Legal Opinion

§15.3(b)(1)(ii) of 67 Pa. Code, Chapter 15, "Authorized Vehicles and Special Operating Privileges," authorizes maintenance vehicles to back up on limited access highways and to drive in a counter-flow direction. Moreover, the Office of Chief Counsel supports this position in the following legal opinion:

*"It is our opinion, and you are hereby advised, that your interpretation is correct, and the vehicles you describe (Department maintenance vehicles) would, in performing the necessary maintenance activities, be exempted from Section 3702. Section 6107 of the Vehicle Code (75 PA C.S. Section 6107) provides that the Department may designate any vehicle as authorized upon a finding that the vehicle is used in the performance of public service or government functions, and that duly authorized vehicles are exempted from certain provisions of the Vehicle Code as should be specified in regulations promulgated by the Department. These regulations were duly promulgated and are applicable to the activity discussed."*

## Mobile and Stationary Maintenance Operations

Based on recommendations from the Work Zone Traffic Control Safety Task Force, the following figures for Department force apply to short-term, mobile, or stationary operations, and comply with the *MUTCD*.

- a) The PATA 11A and 11C drawings of Publication 213 generally apply to the following operations, and other similar operations for roadways with an ADT of 1,500 or less:
  - Shoulder grading
  - Shoulder stabilization
  - Shoulder cutting
  - Mechanized patching
  - Surface treatment
  - Sub-base repair
  - Skin patching
  - Scratch coat
- b) The PATA 11D drawing of Publication 213 applies to pipe replacement.

## Mowing Operations

- a) The "MOWING NEXT \_\_\_ MI" (W21-14) sign is optional for either contract or Department mowing operations. However, Districts are encouraged to: (1) use the "whip type antenna" with the fluorescent orange flag on all mowing equipment; and (2) paint the roll bar framework on Department mowing equipment a bright orange. See the figures in Publication 213 for additional information.
- b) The requirements of PennDOT Publication 213 will still apply and must be followed for mowing operations. These guidelines allow for the use of a shadow vehicle. Consider the use of a shadow

vehicle when the mowing operation is on the travel portion of the highway and the sight distance (in feet) to the work vehicle (mowing equipment) from behind is less than ten times the speed limit (in miles per hour).

### Department Surveying Operations

Highway surveying operations that block any portions of a travel lane shall comply with the following guidelines. The Department's Survey Crews are subject to the requirements of Chapter 212, Publication 213, and the *MUTCD*. The SURVEY CREW (W21-6) sign should be used in lieu of the ROAD WORK AHEAD (W20-1) sign for surveying operations.

## 6.14 Traffic Control Plan (TCP) Design Considerations

### General

- a) Refer to Section 6.3 for the Work Zone Safety and Mobility policy for specific requirements and procedures on the determination of "Significant Projects" and the development of Transportation Management Plans (TMP) for projects classified as "Significant." The Traffic Control Plan (TCP) will be included by reference within the TMP when a TMP is developed for a specific project. Additional guidelines intended to supplement Section 6.3 is included in this Section.
- b) Consider the maintenance and protection of traffic on construction projects during the pre-design and design phases of the project. It is the District's responsibility to consider appropriate traffic control with the aim to avoid as much disruption and inconvenience to the motorists as is practical while providing adequate safety to motorists and construction workers. Therefore, designers should coordinate this effort with the District Construction and District Traffic Units.
- c) The designer is primarily to consider achieving maximum traffic control through the project and then to develop a design accordingly. Consider road user costs in the maintenance and protection of traffic schemes. In many instances, the type of design may not change, but the method or scheduling of construction may prove significant in the traffic control plan and have an effect on the community.
- d) Where the impacts on the community would be significant, proper coordination with the community and civic leaders are necessary. Their concerns and input must be a part of the evaluation of the maintenance and protection of traffic schemes. Additional guidance on this is provided in Section 6.3 (Work Zone Safety and Mobility).
- e) An evaluation of maintenance and protection of traffic should be included in all phases of design development.

### Work Zone Safety Design Considerations

#### All Highways

The following guidelines apply to all highways (including freeways; expressways; two-lane, two-way highways; arterials; and streets).

- a) Portable dynamic message signs (DMS) combined with active radar can be effective in reducing speeds through work zones. When the radar detects a speeding vehicle, the sign will display a message to inform the driver that he/she is speeding. Districts are encouraged to use one of the following word messages instead of a numeric speed display:

“YOU ARE SPEEDING // SLOW DOWN”

“TOO FAST // SLOW DOWN”

Place the sign(s) at the beginning of the reduced speed area or in advance of other active work activities.

- b) Determine the maximum length of the queue (see [Projecting Hourly Traffic Volumes](#) on page [6-48](#)). Approximately one mile upstream of this point (depending upon the speed limit); use a DMS to provide the estimated distance to the queue. Repeat “BE PREPARED TO STOP” (W3-4) signs at 1-mile intervals to the lane closure or reduction.
- c) To be of any value, signs must be in good condition, convey a clear, concise message, and be placed appropriately for current conditions. Anything less creates disrespect and causes the driver to question the validity of the signs. As a result, the driver may ignore messages that are critical to safety. Regularly review work zone signs for relevance. Signs that are irrelevant or misleading will cause driver confusion and damage our credibility. Immediately remove or cover irrelevant or misleading signs.
- d) Whenever possible, construction vehicles should be restricted from entering or exiting the work area from travel lanes.
- e) Use Glare Screen, 50-inch minimum temporary concrete barrier, as the standard for separating traffic through crossovers and in two-way operations. If the higher barrier would create a sight distance problem, use the 32-inch high barrier.
- f) Whenever traffic is restricted to a narrow travel lane without good shoulders, wheels of large vehicles tend to track beyond the paved area creating pavement edge drop-offs. Therefore, plans should provide for shoulder widening and reconstruction before confining traffic to narrow travel lanes.

### Freeways and Expressways

- a) On major freeway construction projects, develop a formal incident management plan as part of the design phase of the project. If one already exists, update it if necessary. It is important to involve local community representatives, emergency response units, and local police agencies along with the Department in the preparation of the incident management plan, so that everyone understands their responsibilities. See [Section 6.3](#) for further requirements and guidance on the development of incident management plans as part of the Transportation Operations Plan (TOP) and TMP for “Significant Projects.”
- b) When closing the right lane through an interchange area, reduce the spacing between the channelizing devices at the exit ramp to highlight the exit path. In addition, to make the exit sign more visible on long-term operations, use a green-and-white EXIT sign to provide contrast with the orange channelizing devices as illustrated in [Exhibit 6-7](#). (A 48"x48" black-on-orange EXIT sign, i.e., W25-4, may continue to be used for short-term operations.)
- c) Consider installing pole-mounted “cobra head” type luminaries on freeway crossovers. Avoid floodlights since they only illuminate a small area with a bright light that may cause drivers to lose their night sight adaptation. Cobra head streetlights illuminate a larger area and are not as distracting to the driver.
- d) Provide emergency pull-off areas at nominal one-half-mile intervals, adjusted to meet field conditions. Specify standard dimensions for the pull-off areas per [Exhibit 6-8](#). Also require the area

to be paved since gravel pull-offs are more difficult to maintain and provide poor traction for acceleration and deceleration. To highlight the area, install flexible delineator posts or other channelizing devices at 25 to 40 foot intervals.

It is recommended that Emergency Pull-Off” signs be used instead of “Emergency Parking Area” signs which have been used in some Districts, since “parking” gives the connotation that the area can be used for causal stoppages.

- e) Highway Advisory Radio (HAR) can be an effective method of giving motorists up-to-date information. The project office should have a cellular phone hook-up to change the message as necessary. Remotely controlled flashing lights, and the “URGENT MESSAGE WHEN FLASHING” (G60-1A) sign are also effective. Special information regarding FCC licenses is as follows:
- The Radio System Section in the Bureau of Maintenance and Operations (BOMO) manages all HAR call signs and radio station licenses for PennDOT. They will also register these signs with FCC, but the Engineering District Office must retain the original FCC license.
  - During construction, the contractor would normally complete the tasks associated with securing the FCC license for the HAR. Once the HAR is operational, the contractor turns the license over to the District who must maintain it. At that point, the District should forward a copy of the FCC license to the Radio System Section so that they can register the new HAR call signs with the FCC for a Taxpayer Identification Number (TIN).
  - If a District has not already done so, they should forward a copy of all FCC licenses to the Radio System Section. Additionally, please forward copies of new FCC licenses within 30 days after receipt.
  - The FCC only recognizes a few contacts within any agency for centralized coordination, so this is an activity that the contractor or District cannot complete. The FCC requires that each FCC license have a TIN assigned to it. Failure to do so will cause the FCC to suspend the FCC license until a TIN is obtained.
- f) Use the Work Zone Alert and Information Radio, commonly called the “Wizard,” especially when there are a high percentage of commercial vehicles. When used, prerecord up to three messages on the “Wizard” in the office before taking it to the field.
- g) Consider handing out brochures at truck stops. The Bureau of Maintenance and Operations will provide the District Community Relations Coordinator with materials.
- h) Continue the practice of providing enhanced work zone police enforcement, including the practice of stationing an officer in a marked police car with its lights flashing, upstream of any queue buildup.
- i) Consider installing the modified rumble strip pattern upstream of the lane closure or reduction (see [Exhibit 6-9](#)).
- j) On major projects, the contractor (or subcontractor) should assign an employee the full-time job of patrolling the work zone and looking for “knock downs,” damaged, missing, confusing, or irrelevant traffic control devices.

### Enhanced Worker Protection

Consider the use of temporary concrete barriers to protect workers in all freeway and multi-lane work zones when all of the following apply:



- The speed limit is 45 mph or greater.
- When workers would be present within one lane width from a live travel lane.
- The closure applies 24 hours per day for more than 2 weeks.

For operations that meet the above requirements where it is not feasible to provide portable concrete barriers, shadow vehicles as defined in Section 6.11 of this document should be specified at individual work sites to protect workers.

#### **Bicyclist and Pedestrian Accommodation**

- a) In the areas where bicycle or pedestrian use exists, traffic control plans (TCPs) should include provisions to accommodate bicyclists and pedestrians. The TCP may consist of a modified Publication 213 drawing that reflects these special provisions.
- b) Protect pedestrians from work vehicles, equipment, and operations. Some circumstances may require establishing a detour.
- c) Do not expose bicycle and pedestrian pathways to unsafe conditions, such as unprotected excavations, open utility access, overhanging equipment, or other similar conditions.

Exhibit 6-7 Alternate Lane Closure near an Exit Ramp

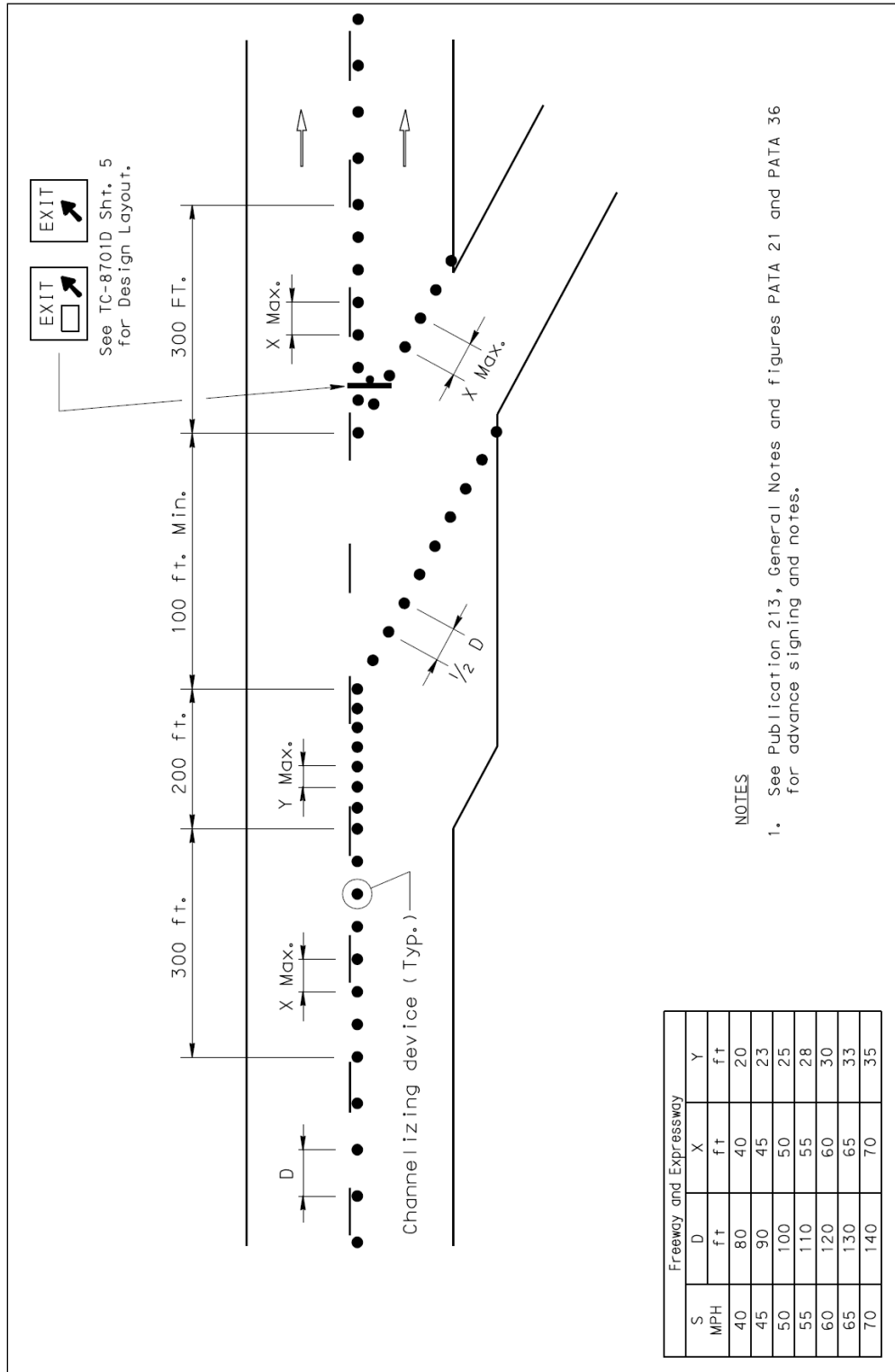

Exhibit 6-8 Emergency Pull-Off

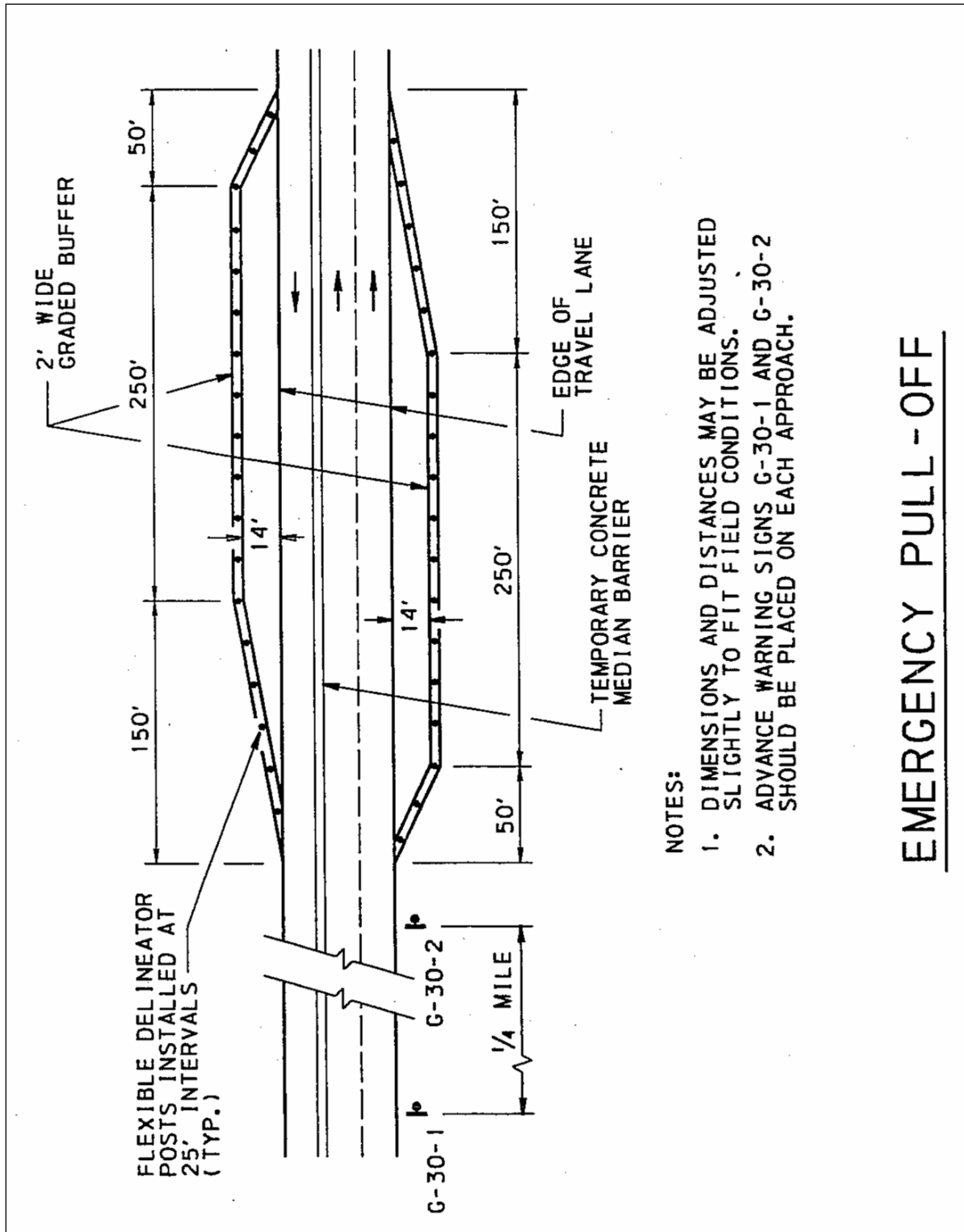
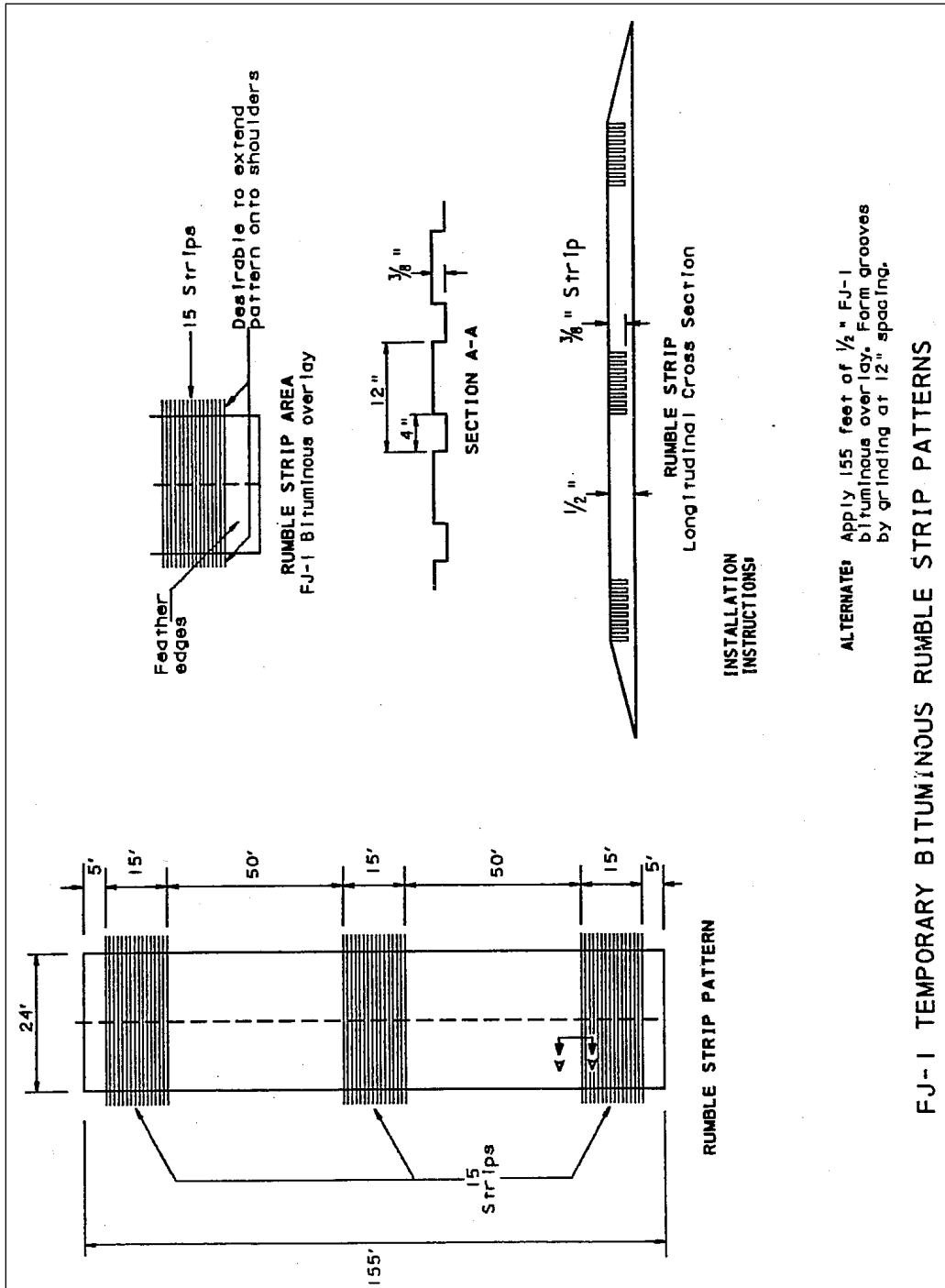

Exhibit 6-9 Temporary Bituminous Rumble Strips



ALTERNATE: Apply 155 feet of 1/2" FJ-1 bituminous overlay. Form grooves by grinding at 12" spacing.

INSTALLATION INSTRUCTIONS

FJ-1 TEMPORARY BITUMINOUS RUMBLE STRIP PATTERNS

**Reporting Management and Oversight Costs**

Act 229 of 2002 requires that “an amount totaling at least one half of 1% of the total dollar amount of projects let annually by the Department of Transportation shall be allocated for the purposes of management and oversight of work zones in order to enhance work zone safety.” Therefore, the Department must track the following costs and annually report them to the transportation committees:

1. State Police Overtime Safety Assistance. BOMO will track this cost; therefore, no action is required on the part of the Engineering Districts.
2. Design of Work Zone Traffic Control. Use the Cost Function “82427” (i.e., “WORK ZONE TRAFFIC CONTROL”) for in-house design of all WZTC items for all Programs. (Note, based on reviews of a cross-section of consultant design expenditures, on a statewide basis BOMO will use a very conservative estimate of 4 percent of all contract design expenditures.)
3. Review of the Design of Work Zone Traffic Control. Use the Cost Function “82457” (i.e., “WORK ZONE TRAFFIC CONTROL”) for this effort for all Programs.
4. Construction Inspection of Work Zone Traffic Control. Use the Cost Function “89967” (i.e., “WORK ZONE TRAFFIC CONTROL”) for this effort for all Programs
5. Local Police Safety Assistance. District should tabulate this cost on a project-by-project basis, as applicable.
6. Cost of Advanced Work Zone Technologies. Districts should tabulate construction line expenditures for queue detection systems, variable speed limits, ramp-metering, technology-assisted enforcement, camera surveillance through the work area, etc., as applicable.
7. Work Zone Training. Districts should tabulate personnel and training costs for design, construction, and traffic personnel.

Of the seven different costs, Districts should provide the annual costs for Items 5, 6, and 7 by July 31 of each year for the fiscal year that ended in the previous month. To help coordinate these expenditures, all Districts are to use the database located at the “Mgmt./Oversight Cost” tab located at [P:\bhste\\_shared\workzones\WZ Annual Reports\WZTC Database \(Annual Report\).mdb](P:\bhste_shared\workzones\WZ Annual Reports\WZTC Database (Annual Report).mdb) (see Exhibit 6-10).

**Exhibit 6-10 Costs to Enhance Work Zone Safety**

The screenshot shows a Microsoft Access Data Form titled "District QA Reviews". At the top, there are fields for "Record Number" (66), "Calendar Year" (2006), and "District" (10-0). Below these are several tabs: "QA INFO", "WZ Crash Info", "Mgmt./Oversight Cost", "Best Practices", "WZ Training", "Measures/Technology", "Policy/Procedures", "ITS in Work Zones", and "BHSTE". A blue box says "Click on Tabs below".

Under the "Mgmt./Oversight Cost" tab, there is a section for "District QA Reviews" with a table showing "Total", "Avg. Score", and "Failures". The values are 0, 0.00, and 0 (0.00%) respectively.

Below this is a section for "Most Common Deficiencies" with a table with two columns: "Deficiencies" and "Comments". The table has 9 rows, with the first row containing "N/A" in both columns. A blue vertical bar on the right side of the table is labeled "BHSTE Use ONLY".

---

## Work Zone Congestion Reduction

### General

- a) Refer to the section **WZSM Implementation** on page 6-5 to determine if a project is a “Significant Project,” and to the section **WZSM Transportation Management Plan (TMP)** on page 6-12 for the development of Transportation Management Plans (TMP) for “Significant Projects.”
- b) It is desirable to incorporate congestion mitigation measures in all construction projects (I4R, 3R, Bridge, Preventive Maintenance, etc.). The goal is to minimize delays to motorists as much as practical.
- c) Consider the following three principles in the design of projects to minimize construction delays:
  1. Avoid recurrent congestion (Level of Service E) if possible by maintaining all travel lanes or by specifying the work hours for times when congestion will be minimal. When this is not possible, recurrent congestion should be minimized by using innovative contracting procedure incentive/disincentive clauses such as the “A+Bx concept” and/or the lane rental methods.
  2. Delay times (stoppage) due to construction operations (normally encountered on resurfacing of two-lane highway projects) should be minimized to no more than 5 minutes, if practical.
  3. Minimize delay problems associated with incidents in the work zone by proper planning and, where practical, develop an incident management plan.
- d) Refer to the section **WZSM Transportation Management Plan (TMP)** on page 6-12 for the Work Zone Safety and Mobility Policy for specific requirements and procedures on the development of Transportation Management Plans (TMP), for “Significant Projects,” and proper development and application of TMP provisions to mitigate work zone congestion issues. It is desirable to identify and address congestion issues as early as possible in the project development process. Also, scrutinize and adjust maintenance operations on freeways and other high-volume arterials to avoid congestion.
- e) To address congestion, Districts should put together teams consisting of one or more representatives of Traffic, Design, Maintenance, and Construction to address the above situations.
- f) Examples of congestion and delay mitigation provisions to consider are as follows:
  1. On freeways and expressways, first consideration should be to maintain all travel lanes, if practical, particularly if a capacity analysis indicates significant congestion associated with lane reductions will occur during several consecutive hours. (Generally assume 1,200 to 1,600 passenger car equivalents per hour, per lane, but the actual value should be refined based on local conditions.)
  2. Restrict work hours to nighttime, weekend, or other off-peak hours. The use of accelerated cure concrete can help ensure the quick reopening of lanes. Also consider special provisions restricting operations that take out a lane temporarily (e.g., setting barriers in off-peak periods).
  3. Letting of projects so that as much work as possible can be accomplished before or after the “Memorial Day to Labor Day” period.
  4. Tighter CPM schedules to force overtime and get work off the road quicker.

5. Using incentive/disincentive clauses such as, the “A+Bx concept,” “lane rental,” and other innovative contract procedures.
6. When appropriate, use provisions in 3R and preventative maintenance projects, particularly on two-lane, rural highways to minimize the length of stopped delay time due to construction operations.
7. Coordination of projects so that corridors with a high volume of through traffic do not have several construction projects underway at the same time. This is very important if there will be substantial delays at each project.
8. Prior to construction, establish incident management plans for all freeway and expressway projects involving the Department, police, contractors, and emergency responders to minimize the length and impact of incidents. Districts should also review alternate routes for the preplanned detour routes in the event that the alternate route is not available when needed due to an incident or routine maintenance.

### Improved Traffic Flow

- a) Consider maintaining all lanes of traffic, by shoulder widening or some other means, to remove traffic completely from the work area. Although material costs may be higher, the removal of traffic may simplify the construction of the project and reduce unit prices and the maintenance and protection of traffic.
- b) For concrete patching operations on freeways and multi-lane highways which have a speed limit of 45 mph or greater, adhere to the following:
  1. Use high, early strength concrete for pavement repairs whenever traffic flow will be impaired by a long-term lane closure. Include special provisions that minimize the closure time.
  2. On high volume facilities (25,000 ADT or greater), establish construction sequencing to close the lane after the evening peak period and reopen it prior to the morning peak period. Schedule work so that excavations can be replaced prior to reopening the roadway, or use temporary material in the excavated patch area to reopen the lanes during daylight hours. Allow exceptions on a case-by-case basis, based on the justification.
- c) Use innovative contracting to reduce the duration of the work zone (e.g., night work, A+Bx, lane rental, and incentive/disincentive) on a minimum of 80 percent of all projects where State Police protection is requested due to anticipated traffic queues.
- d) The length of lane closures should be as short as possible. Whenever possible, use a short “rolling work zone.” On limited access highways, the maximum length of lane closures should be 3 to 5 miles with at least 2 miles between adjacent work areas unless documentation shows that a longer length minimizes road user costs, or substantially shortens the overall duration of a lane closure. Permit exceptions only on a case-by-case basis.
- e) Design freeway projects for a work zone speed limit of not more than 10 mph below the normal speed limit. To accomplish this, long transitions, good sight distance, and excellent delineation are essential. To assist motorists on wet nights, use temporary RPMs or “wet reflective” temporary pavement marking tape throughout the project unless drums or vertical panels are used along the travel lanes to provide a high level of nighttime delineation.

- f) Give attention to speed zone restrictions to ensure that the restriction only applies to the area of need. For example, if the speed limit is to improve safety for workers, confine the restriction to the active work area and not throughout the limit of work or during those times when workers are not present. Therefore, it will be necessary to both cover and uncover speed limit signs, or to include special provisions in the contract to require remotely-activated speed limit signs.

#### **Late Merge Concept**

- a) The “late merge” concept uses a unique traffic control setup on freeway construction projects when it is necessary to close a travel lane. Instead of encouraging motorists a mile or more before the lane closure to form a single lane, this setup encourages motorists to use both travel lanes up to the merge point.
- b) Potential benefits of the “late merge” concept include the following:
  - 1. Queued vehicles can stack in two lanes thus making the length of any queue shorter. This may eliminate backups through nearby interchanges, thereby reducing delays for entering and exiting traffic.
  - 2. Studies performed by a consultant and the University of Nebraska suggest that the capacity of a lane reduction may be up to 15 percent greater with the late merge concept, as opposed to using the conventional traffic control. If this is universally true, the “late merge” should reduce any queues to less than 50 percent of the queue length in a normal lane closure.
  - 3. The potential to reduce road rage caused by some motorists passing the queue and butting in line. This allows motorists to drive at a more relaxed and uniform speed.
- c) **Exhibit 6-11** is a suggested traffic control plan for the “late merge” concept.

NOTE: Field experience in Pennsylvania has showed mixed results with the late merge concept across the state. In some cases it has worked well and in others it has not. There does not seem to be any apparent pattern as to the success of implementing the late merge concept. It has been tried in both urban & rural settings as well as different geographical regions of the state. Districts are still encouraged to consider this approach wherever the throughput capacity may be an issue, while at the same time taking into account past experience as to where the late merge concept has worked and where it has not. Experience has shown that the late merge concept is not as beneficial in areas with typical free flow conditions.



Exhibit 6-11 Late Merge

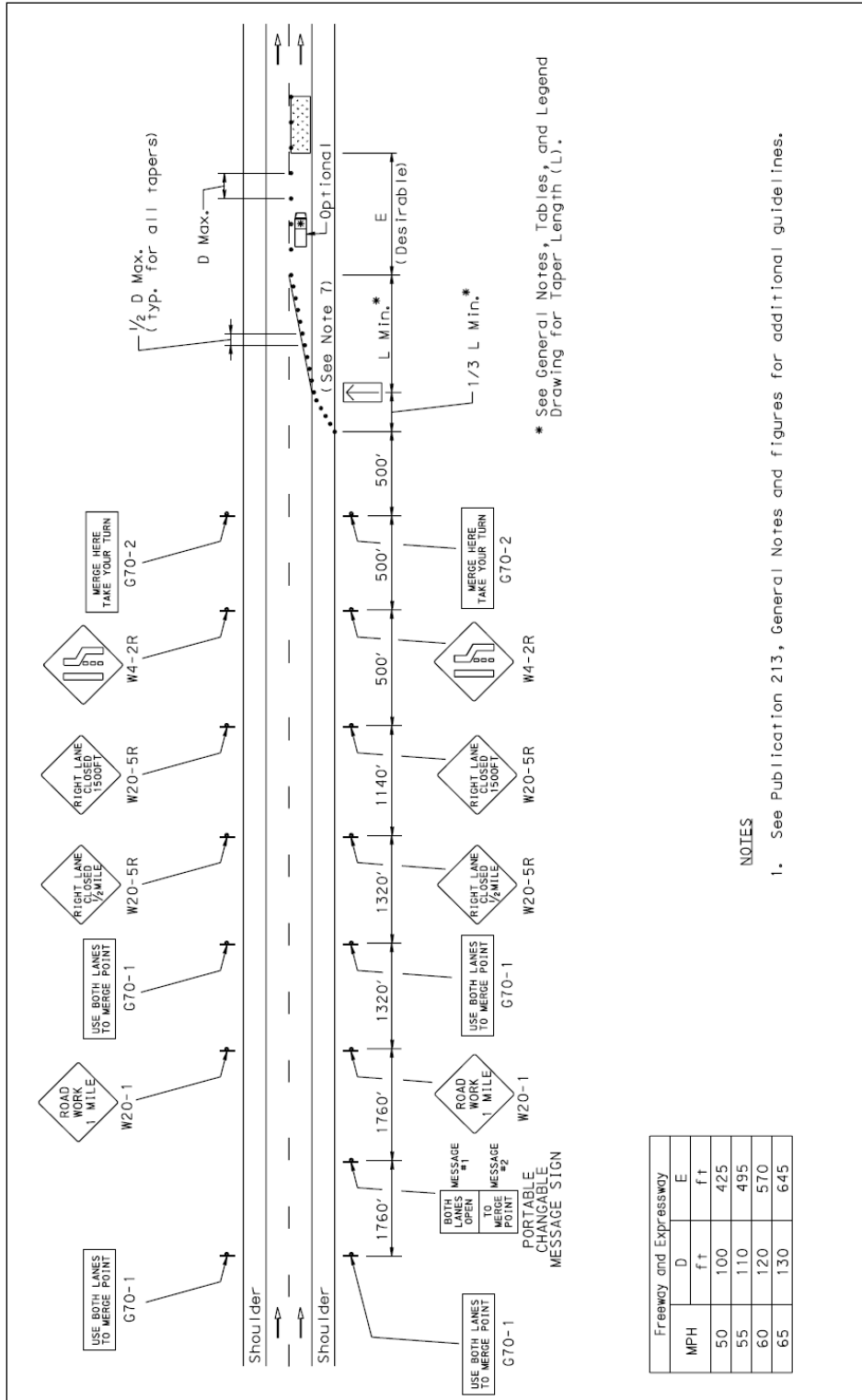

---

**Projecting Hourly Traffic Volumes**

- a) Refer to Section 6.3 for the Work Zone Safety and Mobility Policy for specific definitions, requirements, and procedures to determine “Significant Projects” status.
- b) To plan for major construction projects, it is essential that the designer knows the projected hourly traffic volumes during construction. When they know the projected volumes and capacities, the designer can more accurately determine if incentives, disincentives, lane rental, or other innovative contracting methods are required.
- c) Therefore, the following guidelines apply to all future construction projects involving lane closures during peak traffic conditions on expressways and freeways, as well as other major highways.
  1. Whenever possible, obtain hourly traffic classification counts during the prior year. Take traffic counts in each direction during the most critical month of the proposed construction project (see the tables in the website at <http://www.dot.state.pa.us/Internet/Bureaus/pdPlanRes.nsf/PlanningAndResearchHomePage?OpenFrameset>; click on “Transportation Planning Division” and then click on “Traffic Information”). If possible, obtain continuous classification counts for a Saturday and Sunday. If manual counts are necessary, include the period from 6 a.m. to 10 p.m. on a Friday, and other critical periods during the week based on the existence of nearby shopping or recreational facilities, amusement parks, etc.
  2. Use the county growth factors unless more site-specific information is available.
  3. Estimate the maximum percentage of traffic that will divert to other roadways during the peak hour. Take into consideration the availability of alternate routes and planned route-diversion techniques. Normally, the maximum route diversion is about 5 to 10 percent.
- d) By using the results of the traffic counts and analysis, Districts will have a good idea if problems will exist during construction. If the District anticipates recurring severe backlogs, the District should seek methods to reduce the problems, (e.g., incentives, disincentives, route diversion techniques, etc.).
- e) Method #1
  1. Convert the projected hourly traffic volume into passenger-car equivalents, using the techniques in the Highway Capacity Manual to show clearly where the projected demand exceeds capacity (see the tables on the website at <http://www.dot.state.pa.us/Internet/Bureaus/pdPlanRes.nsf/PlanningAndResearchHomePage?OpenFrameset>; click on “Transportation Planning Division” and then click on “Traffic Information”).
  2. For most work zones, assume capacity to be 1,200 pcphpl. The District may use a projected capacity of up to 1,600 pcphpl if employing the “use both lanes to merge point” technique and based on local conditions. If the length of the work zone is more than 5 miles long, or the travel lane(s) is narrow, the capacity may be less.
  3. Based on the projected passenger-car equivalents, determine when the projected demand (including previously queued vehicles) will exceed capacity.
- f) Method #2

Use FHWA’s QuickZone work zone delay estimation tool, which is a Microsoft Excel-based program that generates estimated anticipated delays and queue lengths at approaches to work zones. The

---

program is located at [P:\bhste\\_shared\QUICKZONE](#). However, when using QuickZone, it is important to comply with the following suggestions:

1. Limit the use of QuickZone to freeways and expressways.
2. Traffic volume data should come from traffic counts taken prior to the development of the Traffic Control Plan during the same time of year that the project will be underway. Weekend and holidays should be included.
3. Avoid using QuickZone program default values. RMS data counts may be applicable.
4. Using the knowledge of highways and habits of drivers in the area, select an appropriate work zone capacity for your District (within the range of 1,200 to 1,600 passenger-car equivalents per hour).

## Detours

### Establishing Detours

As currently written, Pennsylvania Statutes Annotated Title 36, "Highways and Bridges," Section 670-423, always mandates the establishment of a detour whenever a State highway is closed. It also mandates signs at every intersection, which by definition would include intersections with alleys. Therefore, all road closures, regardless of ADT, shall have an established detour signed in accordance with Publication 213.

### Construction Detours

- a) [Exhibit 6-12](#) is a legal opinion dated May 19, 1993 concerning detours on local roads. Briefly, it states that Pennsylvania highway law gives the Department the duty to designate, layout, and maintain detours. Therefore, it is not necessary to have an agreement with the local municipality. The Department is obligated however, to repair the detour to a condition at least equal to its pre-detour condition. Further, Districts may make minor repairs to a local road prior to the establishment of the detour to make it safe and passable. It is appropriate for the Department to expend money for this purpose. The repair work is normally included in the contract and performed by the contractor.
- b) Maintaining good relations between the Department and local officials is important. As stated in [Exhibit 6-12](#) first paragraph the Department does not need agreement to use a local road for a detour. It is highly recommended that the District obtain the concurrence of the municipality when establishing a detour on their facilities (See [Chapter 6 Appendix](#) on page [6-61](#) example). If they are strongly opposed to the detour, use good judgment to determine whether to seek an alternate route. In any event, the District must keep local authorities fully informed.
- c) When establishing a detour for motor vehicles, provisions are also required for bicyclists and pedestrians. For example, signs and markings to indicated that the bikeway/walkway is closed and detour directional signing. If the detour is longer than 0.5 mile for pedestrians or 2 miles for bicyclists, consider placing distance measurements at both ends of the detour route (when appropriate, use distances in blocks for pedestrians).

**Exhibit 6-12 Detours on Local Roads**

From my review of the proposed detour use agreement, the Department has selected a township road as detour and will agree to not only bring the road into its pre-detour condition, but to make certain additional improvements to the township road. Please be advised that we do not need an agreement with the township in order to use the township road as a detour. § 423 of the State Highway Law (, Act of June 1, 1945, P.L. 1242, as amended, 36 P.S. §670-423, imposes upon the Department the duty to designate and layout detours and to maintain such in a safe and passable condition. § 423 of the act also statutorily obligates the department to repair the detour to a condition at least equal to its pre-detour condition. Thus, an agreement with the township to establish these responsibilities is not necessary or recommended.

An agreement is only necessary if the detour would involve a private road. § 423 of the Act specified that “whenever necessary in the creation of the detour, the department may enter into agreement with the owners of private lands, privileges over private property for the period when the main highway shall be closed to traffic.” (emphasis added). It goes without saying that the township road being considered for detour use is not a private road.

With respect to the additional improvements requested by the township, it has been the Department’s policy in the past to require reimbursement of all costs associated with the additional improvements. However, if these improvements are necessary to bring the detour in safe and passable condition, then it is appropriate for the Department to incur these costs.

Please advise the township that we will not be executing the proposed detour use agreement.

Sincerely,

Audrey F. Miner  
Assistant Chief Counsel

May 19, 1993

**Detours vs. Maintaining Through Traffic**General

FHWA has provided information relative to detouring traffic or maintaining traffic through the construction zone. FHWA guidelines consider a policy of first weighing the advantages and disadvantages of “closing to traffic” versus “maintaining through traffic.”

The guidelines require an analysis of overall contract and public costs, as well as safety aspects, before making a decision. On some projects, you may easily dismiss the “closing to traffic” alternative, while on other projects; it may be the best alternative.

Some factors to consider in analyzing and deciding whether to close a particular project to traffic are in [Exhibit 6-13](#). The pros and cons of closing a roadway for the duration of construction is examined in detail

in the Work Zone Safety and Mobility Policy. Specifically, refer to Section 6.3 for specific requirements and procedures on the development of Transportation Management Plans (TMP), for “Significant Projects,” and proper development and application of TMP provisions, such as full road closures, targeted at mitigating work zone safety and congestion issues. However, in evaluating the type of maintenance and protection of traffic, the designer should use the PUB 213.

**Exhibit 6-13 Detouring Traffic vs. Closing the Road**

	Positive Factors	Negative Factors
Cost	Lower contract costs possible due to more efficient working conditions and reduced traffic control costs possible in many cases.	Possible increase in cost to the public including vehicles and transit systems and business loss along the closed section. Some businesses may be forced to close down. Advertising for closures and detours may be a substantial cost. Cost (strengthen or repair) for use of detours associated with heavy truck traffic.
Time	Contract production rates should increase due to lack of traffic interference. This should be reflected in the contract time allowed and the contract should contain provisions such as incentive/disincentive to assure this advantage.	Detour time to the public may be intolerable in some cases. Length and/or congestion of the detour may make the closing infeasible, inconvenient, or politically unacceptable. Reduction of emergency services may be a heavy elimination factor.
Energy	Contractor energy costs should be reduced as traffic conflicts are eliminated.	Traveling public may expend more energy in traveling the indirect route of a detour. This may more than offset savings in energy by the contractor. Closing a road to “through traffic” is not generally effective if local traffic must be maintained. If “through traffic” can use the project with less inconvenience than the detour, it normally will do so eliminating or reducing contractor savings.
Safety and Traffic Volumes (see Subchapter 6.3 for more information)	Contractor personnel crashes with vehicular traffic will be reduced. Vehicle crashes with the construction environment will be practically eliminated. Little or no impact to the highway user on low volume roads	On high volume routes, detouring may increase congestion and crashes on alternate routes. May cause mass transit system disruption or failure. May delay or eliminate emergency services.
General		Should unforeseen difficulties arise, it will not be easy to reverse the plans of closing a road after award of a contract. Local governments may not permit traffic to be detoured onto their system from another system for various reasons. Some reasons are noise and air pollution, congestion, school student safety, and reduced emergency services.

### Bridge Construction

Because of negative comments from the public, business community, and the media when closing bridges during major rehabilitation or replacement, the Department reviewed the maintenance and protection of traffic on bridge construction projects. The review indicated that even though project cost was the major reason for specifying detours, other items such as ADT/truck traffic, impact on local economy and emergency services, environmental impact, and ease of getting the needed right-of-way for a temporary crossing should be considered prior to specifying detours. Therefore, Districts need to evaluate options for maintenance of traffic for bridge projects during the preliminary studies and/or environmental studies stage, and perform adequate public coordination to minimize adverse impacts.

Additional guidelines for the maintenance and protection of traffic were developed. The guidelines indicate that generally the selection of maintenance and protection of traffic should be based on the following hierarchy of options:

1. Detour
2. Half-Width Construction
3. New Bridge Adjoining the Existing Bridge
4. Temporary Crossing/Bridge and Approaches

Consider the following for each of the four options:

1. Detour: Consider a detour if any of the following apply:
  - Emergency conditions require closing of the bridge.
  - Moderate and tolerable impact on the local economy, emergency services, school bus routes, etc.
  - The route is other than a high volume and detour length is less than approximately ten miles (local conditions may dictate a different length).
  - The detour does not generate any major controversy.
  - A temporary crossing would cause significant environmental impacts (need for extensive archaeological studies, wetland, 4(f) items, etc.) and/or right-of-way clearance problems.
  - At major river crossings where the new bridge has to be at the existing location and half-width construction is not possible.
  - The cost of improving and/or maintaining the designated detour is less than the cost of the half-width construction or temporary crossing options.
2. Half-Width Construction: Consider this option if:
  - It is compatible with the scope of work and method of construction.
  - Half-width construction is a viable option and traffic signals can control one-lane traffic on the bridge.
3. New Bridge Adjoining the Existing Bridge: Consider this option when the new alignment at least maintains or improves the existing highway geometry and the extension of work limits does not significantly increase the cost of the project.
4. Temporary Crossing/Bridge and Approaches: Generally, this is the most costly alternative; and can be used if:

- The new bridge must be located on the same alignment as the existing bridge and half-width construction is not possible, and
- Detouring is not a viable option.

If selecting a detour on a project that can be completed within one construction season, adjust the project letting date so that the detour will not be required over the winter months. If necessary, specify double shifts or a tight construction schedule with a heavy penalty for delays if the impact on the traveling public and/or affected economic community is severe.

If a temporary crossing/bridge is selected:

1. FHWA must be consulted and approve its use if Federal funds are involved. (“Temporary Bridge Structure” will be added to the list of “Design Items Requiring FHWA Consultation and Approval” in the attachment to the CA document.)
2. A reevaluation of environmental effects will be necessary only if a detour was addressed in the original environmental evaluation process and wetlands, archaeological, or historically sensitive areas are involved. (This is based on the premise that using a temporary bridge in lieu of a detour will have a positive environmental effect.) In addition, DEP and Fish Commission concurrence/approval, if required, will be obtained prior to constructing such temporary bridges.
3. To reduce the cost of a temporary crossing, Districts should consider storing and supplying to contractors used beams and open steel decks removed from existing bridges for such temporary bridge construction.
4. The District should consider specifying, in the proposal, that the superstructure (beams, deck, etc.) elements, when provided by the contractor, will become the property of the Department after construction, in order to build up a stock for future temporary bridges.
5. The form D-4232 (authorization) for construction must include a separate line entry for “Temporary Bridge.” Use regular type code and add “Temporary Bridge” in parenthesis.
6. When the D-4232 for Final Design is prepared, if it is known that a temporary bridge will be used, the “Remarks” section will include a reference to the temporary bridge.
7. If, after the D-4232 for construction has been approved by the FHWA, it is determined that a temporary bridge will be used, an amended D-4232 (including the temporary bridge line entry) will be submitted with appropriate back up data. Obtain federal authorization prior to initiating construction of the temporary bridge.

### Overwidth Vehicles

If the construction project is on a designated network highway or an approved access route that permits the operation of 102-inch wide vehicles, the maintenance and protection of traffic plan should include the continued operation of those vehicles during construction.

If the roadway or lane widths are restricted, consideration should be given to the installation of a sign indicating “VEHICLES OVER (\_\_\_) FT. WIDE PROHIBITED” (R14-16-1). If lane widths are restricted because of construction, coordinate with the District permit office.

## 6.15 State Police Assistance

### Memorandum of Understanding (MOU)

The safety of highway workers and the traveling public is a top priority with both the Department and the Pennsylvania State Police (PSP). Because of a high number of freeway fatalities, in 1994 the Department initiated a cooperative program where PSP troopers were used to alert motorists of traffic queues on freeway projects. The original name for this cooperative effort was the 'Pennsylvania State Police Work Zone Supplemental Safety Enhancement Program,' but this publication uses the term 'PSP Assistance.'

The concept is to position a trooper in a marked patrol car with activated lights on the shoulder of the roadway, and to have the trooper maintain a location about 1/4 to 1/2 mile in advance of the queue to 'wake up' any inattentive drivers. When the troopers use overtime, the Department reimburses the PSP in accordance with a Memorandum of Understanding (MOU) between the two agencies (the current MOU is at [P:\bhste\\_shared\workzones\PSP](P:\bhste_shared\workzones\PSP)).

The program was originally limited to expressways and freeways, but the Memorandum of Understanding (MOU) now allows more flexibility, including application on two-lane, two-way roadways. However, in the Post-9/11 Era, there are additional burdens placed on the PSP and other enforcement agencies. Therefore, there has been some concern over the number of troopers requested for construction projects and maintenance activities, especially on two-lane, two-way highways.

Therefore, Engineering Districts should review their requests for PSP Assistance on two-lane, two-way highways to determine if the number of programmed hours is excessive, or even if any PSP presence is warranted since a well-designed and maintained traffic control setup should provide excellent safety without the presence of a PSP trooper. Districts should also consider ITS technologies to improve safety in an effort to reduce the burden on the PSP. The MOU requires advance approval by both the Bureau of Patrol and the Bureau of Maintenance and Operations (BOMO).

### Budget

Initially, some of the PSP Assistance was at no cost to the Department because troopers used regular time. However, because of other labor needs, Districts should assume that overtime is required for all PSP assistance. In addition to labor charges, the Department reimburses PSP for the cost of the patrol vehicle.

The per hour cost for PSP assistance (includes the vehicle) can be found in the PSP database at [P:\bhste\\_shared\workzones\PSP\Add PSP Projects Here\PSP Database\PSP Assistance Database](P:\bhste_shared\workzones\PSP\Add PSP Projects Here\PSP Database\PSP Assistance Database).

Therefore, when developing a project, each District should budget for anticipated PSP Assistance using the hourly cost for each trooper from the database. Include this cost in the amount that goes for approval by the Program Management Committee (PMC). Districts should indicate the estimated cost for PSP Assistance on the Highway/Bridge phase costs/SPN information screen in the Multi-Modal Project Management System (MPMS). When preparing the request for the Federal Authorization (Form D-4232), include the amount estimated for PSP Assistance as a separate line item and include a comment in the State Remarks field that indicates "Line No. \_\_\_ includes \$\_\_\_ for PSP assistance."

Also, add the estimated amount for PSP Assistance to the Project Development Checklist screen in ECMS (this value must be consistent with the requested amount on the D-4232).



Note: PSP Assistance is not a bid item in the proposal and is not included in the Maintenance and Protection of Traffic items. However, to clarify both the Department and the contractor roles, include the "Pennsylvania State Police Construction Assistance" special provision.

**Administrative Procedures**

Establish the List of Eligible Projects

1. During project development, the Engineering District is to determine if the project warrants PSP Assistance in accordance with the current MOU. Generally, if the normal hourly traffic volume is more than 1,200 passenger cars or passenger-car equivalents, queuing will occur and the District should consider PSP assistance as necessary.)
2. For each warranted project, the Engineering District should estimate the required funding level using the PSP Database to determine the hourly rate for the PSP officer.
3. Each District is to designate a single work breakdown structure (WBS) code for the life of the project for PSP Assistance charges, even if the project crosses county lines.
4. Districts should add eligible projects to the statewide listing at P:\bhste\_shared\workzones\PSP\Add PSP Projects Here\PSP Database\Shortcut to PSP Assistance Database as early as possible, but always at least 3 weeks before PSP assistance is required. When adding new projects, Districts are to include the WBS and Fund codes.

Schedule and Track PSP Assistance

1. Project managers should advise the local PSP stations as far ahead as possible of the anticipated days and hours that assistance will be required. Project managers are also to maintain communication with PSP throughout the life of the project. Project managers should make it clear that contractors may not request PSP assistance.
2. On larger projects, project offices are encouraged to provide a cell phone to the PSP station for use by the troopers to improve communication with the project office.
3. A PSP trooper is to advise the project office of the number of officers that are on the project, their time of arrival and the time of their departure. If the project provides a cell phone for the PSP, the trooper should call at the times of arrival and departure. If the project does not provide a cell phone, the trooper may stop at the project office, have the dispatcher leave a telephone message, or provide the information by a mutually agreeable method. If the information is not provided, then a daily estimate of the number of hours is to be made. All project offices are to have an answering machine or an answering service that will allow PSP officers to leave messages during those times when the project office is not staffed. (In accordance with the MOU, PSP does not bill travel time to and from the project except for certain occasions.)

If the Department cancels scheduled PSP Assistance within a day of the proposed service, PSP will generally charge the project 3 hours for the call-out even though no service is provided.

4. Project offices should maintain a log in order to record the daily number of hours of assistance at the project office. Project offices are encouraged to use a spreadsheet such as the one at P:\bhste\_shared\workzones\PSP Spreadsheet Template.xls (please copy and save to another file name), which will automatically calculate costs and maintain a budget balance.

## PSP Requests Secondary Cost Element (SCE) from Integrated Enterprise System (IES)

5. Coding for expenditure commitment item, cost center, and funds will be supplied by the PennDOT Bureau of Fiscal Management (BFM).

## PSP Submits Preliminary List of Charges for PennDOT Review

1. PSP will prepare a detailed listing of project-by-project charges every month, and will send an electronic copy of the spreadsheet to the Bureau of Maintenance and Operations (BOMO).
2. BOMO will review the list and forward it to the Districts for verification of ECMS and WBS numbers. The District will respond back to BOMO within 10 working days.
3. When all items are verified, BOMO will notify PSP of any necessary changes, and/or give them authorization to submit the Pre-Note (invoice).

## PSP Comptroller's Office Sends Pre-Note to Transportation Comptroller's Office

1. PSP Comptroller's Office sends the Pre-Note to the Transportation Comptroller's Office.
2. Transportation Comptroller's Office seeks BOMO concurrence.
3. BOMO requests Bureau of Fiscal Management (BFM) to make funds available in payment account.
4. If PennDOT does not object within 14 calendar days, SAP automatically pays the invoice. If an objection is made, the "14-day clock" stops until all issues are resolved.
5. BOMO will perform the cost distribution. This will transfer expenditures from the initial payment account to the individual projects by the WBS codes and their corresponding cost centers and funds.

**Coordination**

The PSP Assistance program requires the cooperation of both the Department and the PSP. Any concern expressed by the PSP need to be addressed and the Department must take the necessary steps to ensure that the PSP Assistance program functions as it was intended. As a result, Districts need to comply with the following requirements:

1. Each Engineering District should establish a Program Coordinator to maintain the Approved Project List. This person should also be available as the contact for the PSP or Central Office in case any problems arise.
2. The Program Coordinator should make requests to add a project to the list at least 3 weeks prior to the initial proposed need (1 week is necessary to get the project on the Approved Project List, and PSP needs 2 weeks advance notice so that they can schedule their personnel.

The need for a 2-week advance notice is a major recurring issue that frustrates the Pennsylvania State Police. Therefore, all Districts must be cognizant of this requirement.

3. Department employees are the only persons authorized to call out the PSP. Authorized persons would generally be the Project Engineer or his/her designee for construction projects, and the County Maintenance Manager or Assistant for maintenance activities. However, these authorized persons cannot make any requests for PSP assistance unless the project is first on the Approved Project List.

4. Because of weather and construction scheduling, the authorized person should reconfirm their needs within the last 48 hours.

### **SAP Procedures**

To streamline the SAP process and reduce errors, the following procedures were developed:

- Use work breakdown structure (WBS) and Fund codes.
- For each new project that requires PSP Assistance, designate a single WBS code for PSP assistance.
- Request PSP officers to notify the project office when they arrive and when they leave so that the project office can track projected expenditures for PSP Assistance.
- When no one is in the project office, use an answering machine or answering service to record PSP calls.
- The project manager is to daily record the total hours of PSP Assistance.
- Provide a timely review and approval of the preliminary list of charges prior to the PSP submission of the Pre-Note.

### **Police Assistance in Adjacent States**

When performing highway work at or near our state borders, congestion and backups sometimes spill over into the neighboring state. In these cases, the Department wants to continue the practice of stationing an officer in a marked patrol car upstream of any traffic queues. Since PSP troopers cannot perform this service, Districts must use a police agency from the neighboring state.

To obtain police services in other state, follow these guidelines:

1. Make the initial contact with the police agency as early as possible, i.e., as soon as it is determined that backups will occur in the adjoining state. Initially, make a telephone call and follow up with a letter. Normally, the services requested should be limited to providing an officer in a marked patrol car with its emergency lights activated stationed upstream of the queue. The other state may provide enforcement, but a police presence to warn approaching motorists is the Department's top priority.
2. To obtain service from adjacent state patrols, use a separate pay item to establish a sum of money for the police assistance. Pay the work as a "Service by Others" in accordance with existing specifications governing the performance of extra work on a force account basis. Since each project is unique and requires this supplemental safety effort under different circumstances, it is not possible to provide a standard special provision; therefore, Districts need to develop a project-specific special provision.
3. To obtain services from the Maryland State Police, contact the Bureau of Maintenance and Operations (BOMO) since a MOU is currently in place.
4. Districts are encouraged to have a face-to-face meeting with representatives of other police agencies to discuss the project, iron out any difficulties in the call-out procedure, and to meet the officers who will be providing the service. If the other state is using local police, invite a member of the PSP to attend the meeting by contacting the Patrol Lieutenant from the station in which the construction project is located.

---

## Additional Guidelines for Maintenance Projects

### PSP Assistance

The following additional guidelines and information apply to PSP Assistance for maintenance projects.

1. If the need for PSP Assistance is anticipated for maintenance, the District Work Zone Manager in conjunction with the County Maintenance Manager is to provide a blanket state project number to the Bureau of Maintenance and Operations (BOMO). Complete this task at least 3 weeks before the first anticipated need.
2. BOMO will include the county maintenance activity as a “project” in the statewide listing of projects for State Police assistance. In this listing, BOMO will use a “dummy CMS number” consisting of the county code followed by three zeros (e.g., Allegheny County will always be “111000”) to distinguish these charge numbers from the CMS numbers used on construction projects.
3. At least 2 weeks in advance of the PSP Assistance, schedule it (date and hours) with the local commander. The County Maintenance District will be subsequently charged for all PSP overtime expenses in accordance with MOU (including an hourly rental rate for the patrol vehicles).
4. All requests for PSP assistance should be made to the appropriate PSP Troop Headquarters and come from either the County Maintenance Manager or one of the assistants. If making adjustments in the schedule, it is the county’s responsibility to keep the Troop Headquarters advised. The person requesting PSP assistance should also keep a record of each request, including the date and time, the route number, and the location. Therefore, it is very important that the County keep the Troop Headquarters informed in a timely manner.

If the County cancels scheduled PSP Assistance within a day of the proposed service, PSP will generally charge the County 3 hours for the call-out even though no service is provided.
--

5. The trooper should be in the patrol car with lights flashing. If queues are anticipated, the patrol vehicle should be on the shoulder about 1/4 to 1/2 mile in advance of the back of the queue similar to the application on construction projects.
6. IF queues do not exist the troopers will perform enforcement operations in the 2-mile section of highway immediately in advance of the work area or a traffic queue.
7. Because of other commitments, PSP will not always be able to assist PennDOT. In fact, PSP may call the trooper away from the project to take care of an emergency.
8. The use of troopers is to provide added safety and is not to eliminate any normal safety devices.

### Guidelines for Completing the “Information for Police Arrest Report”

Use the “Information for Police Arrest Report,” as included in the [Chapter 6 Appendix](#) on page 6-76, to assist police and report near misses in work zones. Please follow these guidelines when filling out this form.

1. Note as much information as possible – details are imperative.
2. List witnesses.
3. Call the police immediately after the incident.
4. Immediately after the incident, send a copy to the appropriate police jurisdiction.

5. Violations of §3102 (relating to obedience to authorized persons directing traffic) and §3326 (relating to duty of driver in construction and maintenance areas) of the Vehicle Code should also be reported to the police.

## 6.16 Chapter 6 Appendix

**Sample Transportation Management Plan**

**SAMPLE**

**Transportation Management Plan**

**PennDOT District \_-**

**Project # \_\_\_\_\_**

**SR\_\_\_\_\_Section\_\_**

**From Seg\_\_\_\_\_Offset\_\_\_\_\_ to Seg\_\_\_\_\_Offset\_\_\_\_\_**

**\_\_\_\_\_County**

SAMPLE

Transportation Management Plan

OUTLINE OF CONTENTS

1. INTRODUCTION, TABLE OF CONTENTS, LIST OF FIGURES
2. EXECUTIVE SUMMARY
3. ROLES AND RESPONSIBILITIES
4. PROJECT DESCRIPTION
5. TRAFFIC CONDITIONS (includes safety data)
6. WORK ZONE IMPACT ASSESSMENT
  - A. Long term lane closures
  - B. Night work with short-term lane closures
  - C. Full Interstate closure with detour
7. WORK ZONE IMPACTS MANAGEMENT STRATEGIES
  - A. Traffic Control Plan (TCP)
  - B. Transportation Operations Plan (TOP)
    - i. Traffic Control Supervisor
    - ii. Changeable Message Signs (CMS)
    - iii. Work Zone Speed Limits
    - iv. Lane Closure Requirements
    - v. Incident Management Plan
  - C. Public Information Plan (PIP)
8. TMP PERFORMANCE
9. CONTINGENCY PLANS
10. BREAKOUT OF TMP COSTS



---

**1. INTRODUCTION, TABLE OF CONTENTS, LIST OF FIGURES****2. EXECUTIVE SUMMARY**

This Transportation Management Plan (TMP) is being prepared in accordance with PennDOT Publication 46. The TMP lays out a set of coordinated transportation management strategies and describes how they will be used to manage the work zone impacts of a road project. Transportation management strategies for a work zone include temporary traffic control measures and devices, public information/outreach, and operational strategies such as travel demand management, signal retiming, and traffic incident management.

**3. ROLES AND RESPONSIBILITIES**

The Pennsylvania Department of Transportation (PennDOT) is responsible for the creation, implementation, and enforcement of this plan. The following individuals are responsible for specific activities to carry out the plan:

- Project Manager (design)—creates the plan and incorporates elements of the TMP into the plans, specifications, and estimate (PS&E)
- Inspector-in-Charge—monitors the day-to-day activities being carried out under the TMP and provides feedback to the District Traffic Unit
- District Press Officer—coordinates activities included in the Public Information Plan
- District Traffic Unit—reviews the activities of the TMP and compiles work zone performance data in conjunction with construction personnel/ contractor
- Contractor—performs specific activities provided by the provisions included in the contract in accordance with the TMP. These activities will typically be carried out by the Traffic Control Coordinator.

Any changes to the TMP must be approved, in writing, by the District Traffic Engineer.

**4. PROJECT DESCRIPTION**

The description and location of the project is as follows: \_\_\_\_\_ COUNTY: From Segment 0410 Offset 0400 NB to Segment 0444 Offset 0925 NB and Segment 0411 Offset 0600 SB to Segment 0445 Offset 1357 SB. The scope of the project is concrete patching at selected areas. There are approximately 15 patches at this location. Additionally, the existing guide rail end treatments will be upgraded to current standards. From Segment 0444 Offset 0925 NB to Segment 0504 Offset 2100 NB and Segment 0445 Offset 1357 SB to Segment 0511 Offset 1500 SB. The scope of the project is concrete patching and a bituminous overlay. Additionally, the existing guide rail will be upgraded to current standards; the shoulders will be upgraded; the existing median barrier will be replaced; drainage will be improved, and bridge approach slabs will be replaced. Also, the NB on-ramp at the Pennsylvania interchange will be reconstructed all as indicated on the approved drawings included in the bid package for STATE ROUTE \_\_\_\_\_, SECTION \_\_\_ in \_\_\_\_\_ COUNTY, \_\_\_\_\_ TOWNSHIP.

This section of roadway is a four-lane, rural, limited-access Interstate highway that is not within the boundary of Interstate Management Area. Work will be performed under lane closures.

The project is to be constructed over two construction seasons with a winter shutdown. The anticipated Notice to Proceed date is 12/25/2005, and the completion date is anticipated by 07/25/2007. There are no milestone dates for this project.

The proposed construction phasing can be found on the following page.

CONSTRUCTION ACTIVITIES

PRE-PHASE 1- BEDFORD COUNTY SHORT TERM

RIGHT LANE CLOSURE

- UPGRADE SHOULDERS AS INDICATED

PHASE 1 - BEDFORD COUNTY LEFT LANE CLOSURE

- DRAINAGE UPGRADES
- CONCRETE PAVEMENT PATCHING AND RELATED ITEMS.

PHASE 2 - BEDFORD COUNTY RIGHT LANE CLOSURE

- CONCRETE PAVEMENT PATCHING AND RELATED ITEMS.
- DRAINAGE UPGRADES

PHASE 3 - BLAIR COUNTY (BELLWOOD TO GRAZIERVILLE)

LEFT LANE CLOSURE

- CONCRETE PAVEMENT PATCHING AND RELATED ITEMS
- UPGRADE GUIDERAIL
- STRUCTURE REHABILITATION

PHASE 4 - BLAIR COUNTY (BELLWOOD TO GRAZIERVILLE)

RIGHT LANE CLOSURE

- CONCRETE PAVEMENT PATCHING AND RELATED ITEMS
- UPGRADE GUIDERAIL
- STRUCTURE REHABILITATION

PHASE 5 - BLAIR COUNTY (GRAZIERVILLE TO TYRONE)

LEFT LANE CLOSURE

- INSTALL PAVEMENT BASE DRAIN.
- UPGRADE SHOULDERS AS INDICATED

PHASE 6 - BLAIR COUNTY (GRAZIERVILLE TO TYRONE)

RIGHT LANE CLOSURE

- CONCRETE PAVEMENT PATCHING AND RELATED ITEMS.
- REPLACE BRIDGE APPROACH SLABS AND PAVEMENT RELIEF JOINTS AS INDICATED.
- INSTALL PAVEMENT BASE DRAIN.
- BITUMINOUS OVERLAY (EXCEPT WEARING COURSE) OF TRAVEL LANE AND SHOULDER.

PHASE 7 - BLAIR COUNTY (GRAZIERVILLE TO TYRONE)

LEFT LANE CLOSURE

- CONCRETE PAVEMENT PATCHING AND RELATED ITEMS.
- REPLACE BRIDGE APPROACH SLABS AND PAVEMENT RELIEF JOINTS AS INDICATED.
- STRUCTURE REHABILITATION
- INSTALL PAVEMENT BASE DRAIN.
- DRAINAGE UPGRADES
- UPGRADE MEDIAN CROSS-OVER
- BIT. OVERLAY (ALL COURSES) TRAVEL LANE AND SHOULDER
- REMOVE & REPLACE EXISTING CONCRETE MEDIAN BARRIER
- PLACE SHOULDER BACK-UP & UPGRADE GUIDERAIL

PHASE 7A - BLAIR COUNTY (GRAZIERVILLE TO TYRONE)

RIGHT LANE CLOSURE

- PLACE WEARING COURSE
- PLACE SHOULDER BACK-UP
- UPGRADE GUIDERAIL

PHASE 8 - BLAIR COUNTY (TYRONE TO BALD EAGLE)

LEFT LANE CLOSURE

- INSTALL PAVEMENT BASE DRAIN.
- UPGRADE SHOULDERS AS INDICATED

PHASE 9 - BLAIR COUNTY (TYRONE TO BALD EAGLE)

RIGHT LANE CLOSURE

- CONCRETE PAVEMENT PATCHING AND RELATED ITEMS.
- REPLACE BRIDGE APPROACH SLABS AND PAVEMENT RELIEF JOINTS AS INDICATED.
- INSTALL PAVEMENT BASE DRAIN.
- BITUMINOUS OVERLAY (EXCEPT WEARING COURSE) OF TRAVEL LANE AND SHOULDER.
- DIAMOND GRIND CONC. AS INDICATED AND PAVE SHLDRS.

**5. TRAFFIC CONDITIONS**

Existing roadway traffic data follows:

		<u>TRAFFIC DATA</u>	
HIGHWAY CLASSIFICATION	- RURAL INTERSTATE	CURRENT DATA	- 15,882 (2005)
DESIGN SPEED	- 70 M.P.H.	DESIGN YEAR A.D.T.	- 21,816 (2025)
PAVEMENT WIDTH	- 2 - 24 FT. LANES	D.H.V.	- 2618
SHOULDER WIDTH	- 4 FT. MEDIAN	D	- 65
	- 10 FT. OUTSIDE	T	- 19%

The local school district has requested that access be maintained at the \_\_\_\_ exit at all times from September 1 to June 1. Emergency service providers are located at the \_\_\_\_ exit. Other major traffic generators such as events, shopping, recreation, and tourism locations should be identified in this section.

**6. WORK ZONE IMPACT ASSESSMENT**

Multiple options for controlling traffic in the work zone were considered and analyzed:

- Long term lane closures
- Night work with short term lane closures
- Full Interstate closure

**A. Long-Term Lane Closures** – Long-term lane closures were selected because the added travel time is less than the threshold of 15 minutes as defined in Publication 46. A QuickZone analysis was conducted based on a capacity of 1500 vphpl. The table below provides a summary of the QuickZone results. The maximum queue length of 0.73 miles equates to an overall maximum delay of 9.16 minutes during the Sunday PM peak hour from 5:00 pm to 6:00 pm. This is consistent with delay experienced on similar, nearby projects on this State Route.

SR \_\_\_\_\_ **QuickZone**  
**2.0**                      **Project**      **Summary**

Period with highest delay in After Case

Phase	1 - Stage 1
Direction	Inbound
Day/Time	Sunday 17:00

	Max Queue (Miles)	Max Delay (min)	Total Project User Cost (\$)				Total
			Passenger Cars	Truck	Detour	Econ/Misc	
Baseline	0	0	\$0	\$0	\$0	\$0	\$0
After	0.73	9.16	\$1,881,639	\$611,616	\$0	\$0	\$2,493,255
Total	0.73	9.16	\$1,881,639	\$611,616	\$0	\$0	\$2,493,255

With the relatively low volumes and lack of major traffic generators on this SR, the anticipated traffic impacts are minor. The contractor will be required to maintain access through the work zone for emergency vehicles and school buses. With 19% trucks, the contractor must maintain adequate lane widths at all times and ensure all temporary barrier, signing, and channelizing devices are maintained to meet their needs. Truck percentages are typically higher during the nighttime hours.

- B. Night Work with Short-Term Lane Closures** – Costs associated with loss of productivity and higher risk due to safety implications did not appear to outweigh the benefit to the traveling public. Estimated project cost when night work was estimated to be \_\_% higher than when long-term lane closures were used.
- C. Full Interstate Closure with Detour** – This alternative was not selected or analyzed because there was not a suitable detour route.

**7. WORK ZONE IMPACTS MANAGEMENT STRATEGIES**

- A. Traffic Control Plan (TCP)** – This project will be managed in accordance with the TCP which may be found at [insert ECMS link here]. Construction phasing is described in the Project Description section of this TMP.
- B. Transportation Operations Plan (TOP)**

- 
- i. **Traffic Control Supervisor** - The contractor's project traffic control supervisor is required to be adequately trained in accordance with PennDOT requirements. The traffic control supervisor is responsible for the following:
- Coordinate all traffic control installations, pattern changes, and removals.
  - Inspect long-term traffic control devices and patterns each working day.
  - Inspect each short-term traffic control pattern that is set up.
  - Document the details of these inspections (items inspected, deficiencies discovered, and action taken to correct the deficiencies).
  - Program changeable message signs.
  - Notify immediately the District Traffic Management Center (TMC) of any highway incidents within the limits of the work zone.
  - Perform duties related to data collection, sharing, and performance monitoring.
- ii. **Changeable Message Signs (CMS)** - CMS will be used in the following manner:
- Notify motorists of the start dates of any detours, any major changes to the traffic control patterns, or any short-term road closures.
  - Provide messages specifically related to slowing traffic down or being prepared to stop during any short-term road closures or anticipated traffic queues
  - Provide messages for use during incident management.
- iii. **Work Zone Speed Limits** – This project will incorporate a reduced regulatory speed limit of 55 mph. Install and maintain reduced regulatory speed limit signs in work areas, as indicated on the Traffic Control Plan or accepted alternate plan. Temporarily remove or cover reduced regulatory speed limit signs, except when workers are present adjacent to a travel lane without a positive barrier separating vehicles and workers or when the Engineer determines one of the following conditions exist:
- Potential hazard exists on, or adjacent to, the roadway.
  - Physical restrictions exist; such as narrowed travel lanes, median crossovers, and lane shifts.
  - Reduced speeds are desirable to improve construction quality.
- The Engineer will notify the Contractor, in writing, when one or more of these conditions exist. The notification will include locations, speed limits and a schedule of time periods when the reduced regulatory speed limit is to be in effect.
- iv. **Lane Closure Requirements** - Lane closures will not be permitted on the following dates and times:
- 12 Noon on April 13, 2006 to 9 AM on April 17, 2006
  - 12 Noon on May 26, 2006 to 9 AM on May 30, 2006
  - 12 Noon on June 30, 2006 to 9 AM on July 5, 2006
  - 12 Noon on September 1, 2006 to 9 AM on September 5, 2006
  - 12 Noon on November 22, 2006 to 9 AM on November 27, 2006
  - 12 Noon on April 5, 2007 to 9 AM on April 9, 2007
  - 12 Noon on May 25, 2007 to 9 AM on May 29, 2007

- 12 Noon on July 3, 2007 to 9 AM on July 5, 2007
- No long-term lane closures on SR 0099 are permitted prior to March 1, 2006, or between November 30, 2006, and March 1, 2007.

Any traffic stoppages (emergencies excluded) or "rolling" road closures, regardless of their duration, must be approved by the District Traffic Unit.

Notification will be provided to the emergency services and school districts in the area and will be included in the contract by special provisions.

- v. **Incident Management Plan** – An incident management plan will be developed in accordance with the special provision in the contract. In this plan, a list of 24-hour emergency phone numbers (emergency services and organizations, contractor's representatives, Department representatives, County Maintenance Manager, etc.) will be provided. The incident management plan also requires that the contractor immediately notify the District Traffic Management Center for all lane closures and major incidents so that information may be provided to motorists and other stakeholders via district variable message signs, highway advisory radios, and the statewide road closure reporting and traveler information systems.

The contractor is required to submit an "Emergency Response Plan" at the pre-construction conference. The Emergency Response Plan should include, contact individuals for incidents that occur during non-working periods, alternate contact individuals, and maximum response time

Following an incident, the contractor will conduct an After Action Review with the Department and emergency services and organizations to evaluate the plan. The contractor will modify the plan as directed.

- C. **Public Information Plan (PIP)** – The contractor shall maintain ongoing communication with the Inspector-in-charge regarding phasing of operations that will impact traffic control and transportation operations in the project area. The contractor shall maintain lists of phone and fax numbers for school district, media outlets, emergency services, major businesses in the area, transit companies, nearby trucking firms, and other prominent traffic generators in the project vicinity. The contractor is responsible for notifying these groups of changes in the traffic control phasing at least 48 hours in advance of the phase change as directed by the Inspector-in-charge. The Inspector-in-charge shall coordinate with the District Press Officer to develop and issue press releases relating to traffic control and transportation operations on this project.

8. **TMP PERFORMANCE** – The performance of the transportation management plan will be regularly assessed from two standpoints:
- Monitoring the overall work zone performance

- Evaluating individual TMP strategies

Crash, travel time data, and queue length will be the primary sources information used to determine the overall effectiveness of the work zone traffic management strategies. Since this project was not characterized as “significant” with respect to PennDOT’s Work Zone Safety and Mobility Policy, travel delay monitoring is not an automatic requirement. However, BOMO determined that this project would be one in the sample of the “non-significant” project that would be monitored.

The contactor’s traffic control supervisor shall maintain a daily record of crashes, work zone incidents, and maximum daily queue lengths. This information shall be coordinated daily with PennDOT’s Inspector-in-charge. Feedback from the public through phone calls, in person, or in writing will also be captured.

The IIC will regularly inspect the manner in which traffic control installations, pattern changes, and removals are conducted and check to ensure that the portable changeable message signs are operational and being used appropriately. All this monitoring information will be documented in the project diary.

PennDOT’s IIC will share this information monthly with the District Traffic Engineer. The DTE will also arrange for periodic floating car runs through the project work limits to validate / corroborate work zone performance and to compare the actual queues and travel delays with those estimated as part of the project impact assessment.

The IIC, DTE, and TMC manager will participate in partnering meetings or conduct bi-monthly conference calls to discuss how well the TMP is performing and to verify that the PennDOT project manager, TMC manger, and public safety stakeholders have been receiving timely notifications of incidents as required by the incident management plan.

When the project is completed, the DTE (with cooperation from the contractor, IIC and ACE) will prepare a final evaluation report which will be forwarded to BOMO. *[Note that daily records of delay and queue lengths and the annual reports can be completed by the contractor or a consultant.]* The evaluation will summarize the overall project travel delay impacts. Crash data will also be summarized and inclusion of crashes into Crash Records System will be verified. The TMP implementation costs and how they compare to budgeted costs will be noted. The decision to control traffic primarily through long-term lane closures will be revisited. Local emergency service providers and the schools will be contacted for their feedback on any impacts the project had on their operations. Finally, lessons learned will be documented.

9. **CONTINGENCY PLANS** *[Only include for high-impact Significant Projects]* – This section would specify activities that should be undertaken to minimize traffic impacts when unexpected events such as crashes, inclement weather, unforeseen demand, etc., occur in the work zone.



The following should be included in the contingency plans (when in this section is included in the TMP):

- Trigger points that initiate contingency plan (fatal crashes, queues exceeding x miles, etc.)
- Contact names and 24-hour contact phone numbers of those in charge of the project or in charge of emergency response personnel that serves the project area (TMP manager, ACE, IIC, contractor, local police, and emergency response agency commanders, etc.)
- Decision tree with clearly defined lines of communication and authority. This section would also include coordination strategies between those involved.
- Specific duties of personnel during emergency lane closure operations
- Standby equipment (tow trucks, etc.) and list of personnel available on callout (for emergency response operations)

**10. BREAKOUT OF TMP COSTS**

Item	Description	Quantity	Unit	Unit Price	Total
0901-0001	MPT	1.00	LS	\$350,000	\$350,000
0901-0203	Arrow Panel	2.00	Each	\$4,000	\$8,000
0901-0205	CMS	2.00	Each	\$10,000	\$20,000
0901-0240	Additional Traffic Control Signs	300.00	SF	\$10.00	\$3,000.00
0901-0321	6" STANDARD PAVEMENT MARKINGS, PAINT & BEADS, YELLOW	75,298.000	LF	\$0.20	\$15,059.60
0901-0331	6" STANDARD PAVEMENT MARKINGS, PAINT & BEADS, WHITE	73,768.000	LF	\$0.20	\$14,753.60
0901-0334	24" STANDARD PAVEMENT MARKINGS, PAINT & BEADS, WHITE	320.000	LF	\$5.00	\$1,600.00
0901-0360	TEMPORARY NONPLOWABLE RAISED PAVEMENT MARKER, (ONE WAY W/B)	35.000	Each	\$12.00	\$420.00

**Act 229 Requirements in Chapter 212****§212.419. Special controls in work zones.**

(a) *General.* Special signing required in 75 Pa.C.S. §§[3326](#), [3365](#), [4309](#), [6123](#) and [6123.1](#) will be in addition to the traffic-control devices required by the *MUTCD* and shall be installed in accordance with this section.

(b) *Application.* Signing under this section is discretionary in the following work zones:

- (1) Short duration work, where the operation will be completed in less than 1 hour.
- (2) Mobile operations, where the work moves intermittently or continuously.
- (3) Stationary work where the daily duration of the construction, maintenance or utility operation is less than 12 hours and all traffic-control devices are removed from the highway at the completion of the daily operation, including all advance warning signs.
- (4) Work along highways other than expressways or freeways where the normal speed limit is 45 miles per hour or less.
- (5) Work in response to emergency work or conditions such as a major storm.

(c) *Work Zone – Turn on Headlights Sign (R22-1).* The Work Zone--Turn on Headlights Sign (R22-1) shall be erected as the first sign on each primary approach to the work zone, generally at a distance of 250 to 1,000 feet prior to the first warning sign. On high-speed roadways including all expressways and freeways, the larger advance distances should be used. If work begins at or near a border to this Commonwealth, the R22-1 signs should be installed within this Commonwealth.

(d) *Active Work Zone When Flashing Sign (W21-19).* The Active Work Zone When Flashing Sign (W21-19) shall be erected as close as practical to the beginning of the active work zone.

- (1) The sign should not be erected within a transition or at a location where workers are put at risk when they may need to turn the light on and off.
- (2) When a construction, maintenance or utility project has more than one active work zone and the active work zones are separated by a distance of more than 1 mile, signs for each active work zone shall be erected.
- (3) The W21-19 signs shall be installed on temporary sign posts or on Type III barricades, and a white Type B high-intensity flashing light must be attached to the upper portion of each W21-19 sign. The light shall be activated only when workers are present, and deactivated when workers are not anticipated during the next 60 minutes.

(e) *End Active Work Zone Sign (W21-20)*. The End Active Work Zone Sign (W21-20) shall be erected immediately at the end of each active work zone, except this sign is not necessary if either the End Road Work Sign (G20-2a) or the End Work Area Sign (G20-3) is installed at the end of the active work zone.

(f) *Work zones on expressways or freeways*. When the work zone is on an expressway or freeway, appropriate signs and lights identified in subsections (c), (d) and (e) at on-ramp approaches to the work zone shall be installed.

(g) *Portable dynamic message sign*. A portable dynamic message sign (DMS) may be used in lieu of the R22-1, W21-19 or W21-20 signs.

(h) *Speed display sign*. In Interstate highway work zones with a project cost exceeding \$300,000, a speed display sign shall be installed on each mainline approach to the work zone to inform motorists of their speed.

(1) The speed display sign must display the motorist's speed in miles per hour in numerals at least 18 inches in height.

(2) As an alternative, a portable dynamic message sign (DMS) may be equipped with radar and programmed to display vehicles speeds.

(3) DMSs may also flash appropriate messages such as "YOU ARE SPEEDING" or "SLOW DOWN." The signs shall be placed 1/2 to 1 mile in advance of the physical work zone.

Sand Barrel Layouts

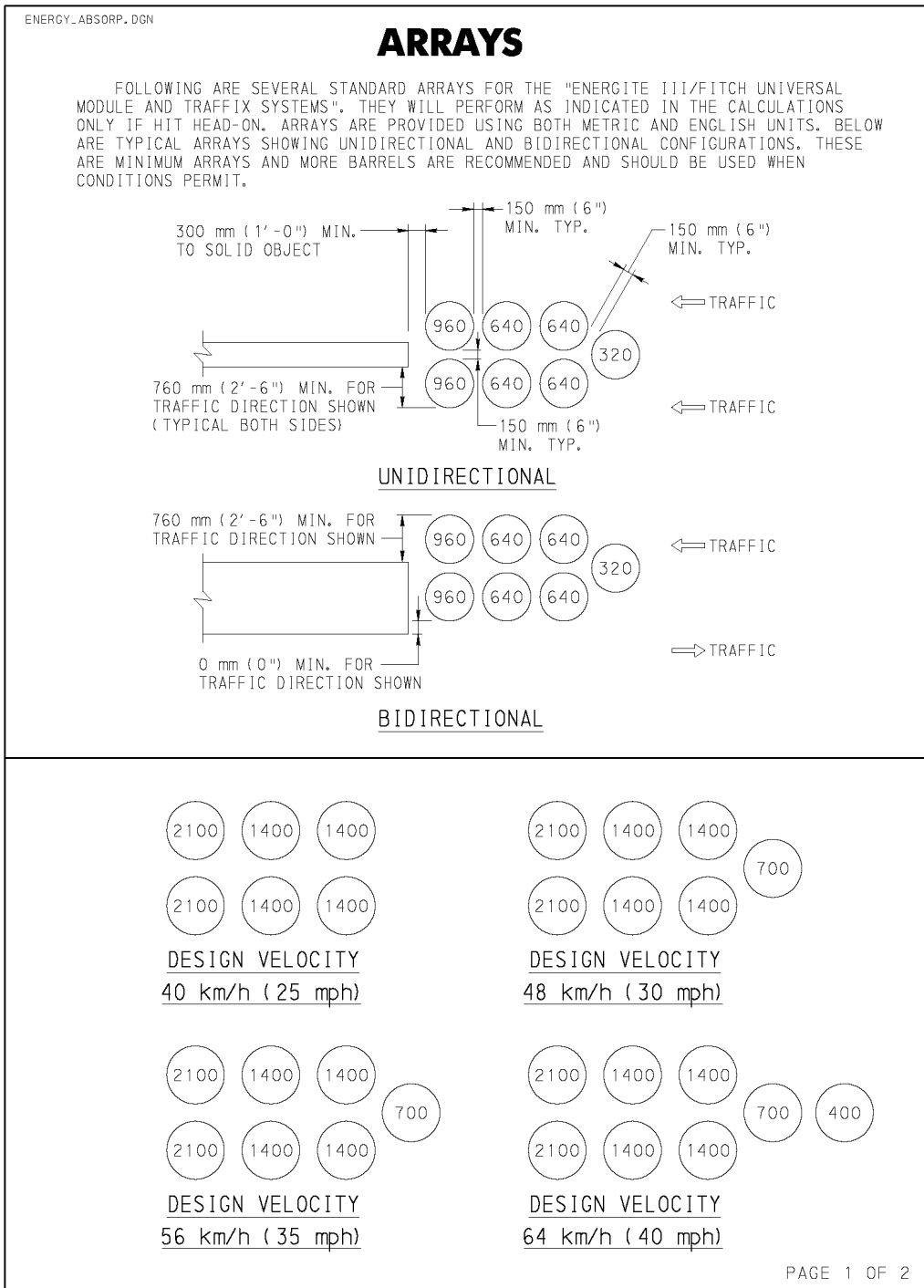

ENERGY\_ABSORP. DGN

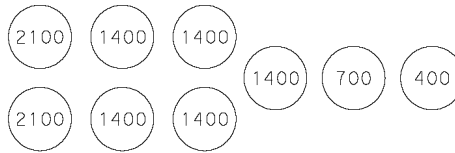

DESIGN VELOCITY  
72 km/h ( 45 mph)

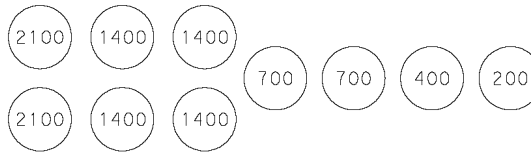

DESIGN VELOCITY  
80 km/h ( 50 mph)

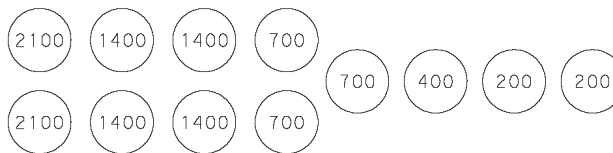

DESIGN VELOCITY  
88 km/h ( 55 mph)

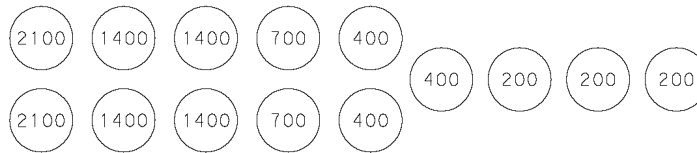

DESIGN VELOCITY  
96 km/h ( 60 mph)

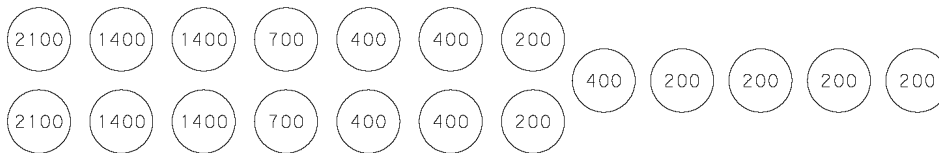

DESIGN VELOCITY  
113 km/h ( 70 mph)

**Guidelines for Required Police Arrest Form**

HS-2 (1-07)



**Guidelines For Required Information For Police Arrest**  
(Check All Boxes That Apply)

**Location of Incident:**  
 County: \_\_\_\_\_ Township/Boro.: \_\_\_\_\_ Local Name: \_\_\_\_\_  
 S.R.: \_\_\_\_\_ Seg/Off: \_\_\_\_\_ Milepost: \_\_\_\_\_

**Description of Vehicle:**  
 Car     Truck     Tractor Trailer     Motor Home     Motorcycle     Other: \_\_\_\_\_  
 Truck Co. Name (if applicable) \_\_\_\_\_  
 Color: \_\_\_\_\_ Make: \_\_\_\_\_ Model: \_\_\_\_\_  
 Plate # (Vehicle/Trailer): \_\_\_\_\_ / \_\_\_\_\_ State: \_\_\_\_\_ Other Markings: \_\_\_\_\_

**Driver:**     Male     Female    Age: \_\_\_\_\_ Hair Color: \_\_\_\_\_ Clothing: \_\_\_\_\_  
 Number/Description of Occupants: \_\_\_\_\_

**Travel Direction:**     North     South     East     West

**Descriptive Statement of Incident:** (Include: Who, What, When, Where, Why, and How)  
 \_\_\_\_\_  
 \_\_\_\_\_  
 \_\_\_\_\_

Date: \_\_\_\_\_ Time: \_\_\_\_\_ AM \_\_\_\_\_ PM    Weather: \_\_\_\_\_

Can any witnesses identify the driver?     Yes     No

**Description of Work Zone:**  
 \_\_\_\_\_  
 \_\_\_\_\_  
 \_\_\_\_\_

Warning signs in place?     Yes     No    **Flagger?**     Yes     No    **Operation Type?**     Moving     Stationary

Regulatory Posted Speed? \_\_\_\_\_ MPH

	NAME	ADDRESS	TELEPHONE NUMBER
WITNESSES			

**Reported By:** \_\_\_\_\_ **Date:** \_\_\_\_\_ **Reported to Police:**     Yes     No

If Yes: **Police Barracks:** \_\_\_\_\_ **Officer's Name:** \_\_\_\_\_

**Example Detour Letter**

Engineering District 8-0  
2140 Herr Street  
Harrisburg, PA 17103-1699  
May 25, 20\_\_

Dover Township  
SR 4014-003 Project  
Detour for SR 4014 (Harmony Grove Road)

Betty A. Shoemaker, Manager  
Dover Township  
2480 West Canal Road  
Dover, PA 17315

Dear Ms. Shoemaker:

The Department is preparing a construction project on Harmony Grove Road (SR 4014). A portion of roadway will be totally reconstructed, therefore a detour is required while the road is closed.

The Department is proposing to use Blackberry Road (T-819) as a detour route to move motorists around the road closure. We have attached a Memorandum of Understanding along with the detour route that we are planning to use during construction.

Please review and sign the Memorandum of Understanding and return it to our office as soon as possible.

If you have any questions or require additional information, please feel free to contact \_\_\_\_\_ in our Traffic Unit at \_\_\_\_\_.

Sincerely,

\_\_\_\_\_  
District Executive

Example Detour Agreement

Pennsylvania Department of Transportation  
Engineering District 8-0

Municipal Roadway Detour

On this \_\_\_\_\_ day of \_\_\_\_\_ 20\_\_ the Commonwealth of Pennsylvania, Department of Transportation and Dover Township of York County have entered into an understanding whereby the Department of Transportation may utilize a municipally owned roadway(s) for the purpose of establishing a detour. The roadway(s) are described below.

- ◆ *Blackberry Road (T-819) from PA 74 to Harmony Grove Road (SR 4014).*

The duration and time for the enactment of this detour is anticipated as: (12 weeks)

The Department of Transportation will provide the following services for establishment of the detour as shown on the attached plan.

- ◆ *Place and maintain all detour signing.*
- ◆ *Restripe of double yellow pavement markings on Blackberry Road (T-819) before detouring traffic.*

Upon removal of the detour, the roadway condition will be equal to the condition at the time of the placement of the detour.

Municipal Official	Title	Date
--------------------	-------	------

County Manager	Date
----------------	------

Approved by: _____	_____
District Executive	Date



## CHAPTER 7 - SCHOOL AREAS

### 7.1 General

#### Need for Standards

The best way to achieve safe and effective traffic control to protect school students is through the uniform application of realistic policies, and standards developed through engineering judgment. Therefore, whenever possible, the Department should always follow the *MUTCD*.

Signs and pavement markings should also conform to those policies established in Chapters 2 and 3 of this manual. All school warning signs shall use retroreflective sheeting, either yellow or fluorescent yellow-green, but local authorities should be encouraged to avoid mixing the two colors whenever possible.

#### Laws, Regulations and Other Publications

*Hazardous Walking Routes (67 Pa. Code Chapter 447)*. Regulations issued under the authority of the Public School Code of 1949 (24 P.S. §§13-1362 and 25-2541) to help determine where student-walking routes are hazardous, which in turn affects the amount of reimbursement that school districts receive for busing school students. This regulation is available at <http://www.pacode.com/secure/data/067/chapter447/chap447toc.html>.

*Manual on Uniform Traffic Control Devices (MUTCD)*. Part 7 is titled, "Traffic Control for School Areas", and is available at [http://mutcd.fhwa.dot.gov/pdfs/2009/pdf\\_index.htm](http://mutcd.fhwa.dot.gov/pdfs/2009/pdf_index.htm).

*Pennsylvania Drivers Manual*. This manual provides guidance for drivers, and is available at <http://www.dmv.com/pa/pennsylvania/driver-handbook>.

*School Trip Safety Program Guidelines*, 1984 Edition (ITE).

*Traffic Control – Pavement Markings and Signing Standards (PennDOT Pub. 111)*. Standard drawings specifying the types, dimensions, locations and lighting of signs on expressways and freeways, and the legend spacing and sign supports for signs on all highways. Available at <ftp://ftp.dot.state.pa.us/public/PubsForms/Publications/PUB%20111M.pdf>

*Vehicle Code (75 Pa.C.S.)*. The Pennsylvania Vehicle Code is law that typically defines actions required by drivers and the Department. Specifically, [§3365\(b\)](#) discusses the establishment of the 15 mph school zone speed limit. In addition, [§3345\(a\)](#) discusses the driver's responsibility when approaching a school bus.

#### Definitions

The following words and terms, when used in this chapter, have the following meanings, unless the context clearly indicates otherwise:

*Divided highway* – A highway divided into two or more roadways and so constructed as to impede vehicular traffic between the roadways by providing an intervening space, physical barrier or clearly indicated dividing section. Each roadway of a divided highway is a "separate roadway" as used in [75 Pa.C.S. §3345\(g\)](#).

*Elementary students* – School students in kindergarten or grades one through six.

*Hazardous* – An unsafe condition caused by potential incompatibility between vehicles and school students, while the students are walking between their home and their school or school bus stop.

School zone – A portion of a highway that at least partially abuts a school property or extends beyond the school property line that is used by students to walk to or from school or to or from a school bus pick-up or drop-off location at a school.

Secondary students – School students in grades 7 through 12.

Separate roadway – One of the roadways of a “divided highway.”

Shoulder – The portion of the highway contiguous to the roadway used for accommodation of stopped or parked vehicles, for emergency use or for lateral support of base and surface courses.

Sidewalk – That portion of a street or highway or other public right-of-way that is reserved exclusively for pedestrian travel and is normally protected by a minimum average 4-inch high, non-mountable curb, or is not immediately adjacent to the roadway. A sidewalk should have a minimum width of 2 feet; a gravel, brick, stone or paved surface; and be available for use during normal weather conditions.

Student-walking route – The system of streets, shoulders, sidewalks and crosswalks used by school students when walking between their homes and their school or school bus stop, officially designated by the school district or, where no official route has been designated, used by school students because of the unavailability of a reasonable alternate route.

## 7.2 School Zone Speed Limits

### Criteria

The criteria to determine if a 15-mph school zone speed limit is applicable is in 67 Pa. Code §212.501 (see [Chapter 7 Appendix](#) on page 7-7).

**PLEASE NOTE:**

1. In accordance with §212.501(a), a 15-mph school zone speed limit is only applicable when at least one student walks to school.
2. The Department must approve all school zones, including the location and hours of operation of the speed limits on both State highways and on local roads, except as noted in §212.501(a)(2).

### Signing Requirements

Posting requirements are included in §212.501(b).

## 7.3 Student-Walking Routes

### Legislative Requirement

The Public School Code of 1949 (24 P.S.) requires the Department to take into account all relevant safety factors for student-walking routes when certifying whether or not walking constitutes a hazard to the students. § 25-2541(c) of the Code is included as [Exhibit 7-1](#).

### Department Regulations and Interpretations.

The regulations for Hazardous Walking Routes (Chapter 447 of Title 67, Pennsylvania Code) establish criteria for determining if student-walking routes are or are not hazardous for the students (see [Chapter 7](#)

**Appendix** on page 7-9). In addition to the regulations, the following interpretations provide guidance in evaluating the requests:

- a) When requested by the school district, the Department will evaluate a student-walking route regardless if a student is walking from home to school or to a school bus stop, or if the student is being transported by either a private or a school district conveyance.
- b) Crossing at a signalized intersection may be declared hazardous for an elementary school student if all of the following apply:
  1. The signal installation does not include an exclusive pedestrian walk phase.
  2. An adult crossing guard is not permanently assigned to the signalized intersection during the school year.
  3. Sight distance, traffic volumes, or roadway widths make it difficult for an elementary student to cross safely.
- c) Crossing at a signalized intersection may be declared hazardous for all school students if an adult crossing guard is not permanently assigned to the signalized intersection during the school year and one or more of the following is satisfied:
  1. The complexity of the operation or design of the signal system is such that:
    - signal indications do not readily provide a visible indication for the school student desiring to cross the intersection; or
    - a multi-phase signal operation exists and it may not be apparent what traffic is being given a green indication.
  2. A 4.5-foot tall student using a crosswalk within the intersection may not be visible at a point that allows an approaching driver turning across the crosswalk to come to a safe stop.
  3. The number of approach lanes and/or the complexity of the geometries of the intersection makes it difficult for a secondary school student to traverse the intersection or to reach a safe refuge.

### Field Study and Evaluation

The Department will determine if a student-walking route is hazardous when a written request is received from the school district. If a request is received from anyone other than the school district, the Engineering District will return the request with a letter explaining the Department's policy for evaluating student-walking routes. The District should also copy the school district, and include a copy of the original request. This will bring the potentially hazardous situation to the attention of the school district and serve as an official notification from the Department.

It is the responsibility of the school district to complete one or more Study and Data Sheets (see **Chapter 7 Appendix** on page 7-14) for each street or highway within the student-walking route. If the Department receives a request from a school district without the Study and Data Sheets, the request should be acknowledged by letter, asking the school district to provide the completed sheets. (The Department will provide a copy of Chapter 447 and one or more copies of the Study and Data Sheets.)

After receipt of the completed forms, the District Traffic Unit will evaluate the information on the Study and Data Sheets to determine if the student-walking route is or is not hazardous for the students. At the District

Traffic Unit's discretion, they may field verify any of the information. The District Traffic Unit shall conduct a study to determine if the student-walking route is or is not hazardous.

If the Engineering District cannot issue a certification within 2 weeks, the District Traffic Unit should acknowledge the School District's request and advise them when they should anticipate the certification.

**Certification**

Justification for Hazardous Certification

The District Traffic Unit will prepare the certification (see [Chapter 7 Appendix](#) on page 7-20) for a basic format). If the student-walking route (as defined on the Study and Data Sheets) is hazardous, the certification form shall cite the section(s) of Chapter 447 or the appropriate sections of this policy which was used to declare the route hazardous. For example:

*The results of the investigation indicate that sidewalks do not exist, the shoulders are less than 4 feet wide, the roadway width is less than 20 feet wide and one or more trucks with three or more axles were observed using the roadway during the time the elementary students are enroute to or from school. Therefore, in accordance with the provisions of §447.4(b)(1)(i), this route is declared hazardous for elementary students.*

Partial Hazardous Certification

If one or more portions of a designated walking route is determined to be hazardous and the balance is determined to be non-hazardous, certify the student-walking route accordingly. For example, a certification form could indicate:

*The results of the investigation indicate that the section of Street "X" between " \_\_\_\_\_ " and " \_\_\_\_\_ " does not have sidewalks, the shoulders are less than 4 feet wide, the roadway width is less than 20 feet wide and one or more trucks with three or more axles were observed using the roadway during the time the elementary students are enroute to or from school. Therefore, in accordance with the provisions of §447.4(b)(1)(i), this section of Street "X" is declared hazardous for elementary students. The remaining sections of Street "X" between " \_\_\_\_\_ " and " \_\_\_\_\_ " are non-hazardous.*

Approval of the Certification

The District Executive should sign the certification and forward copies to the school district and to the following address:

Pennsylvania Department of Education  
 Bureau of Budget and Fiscal Management  
 Division of Subsidy Data and Administration  
 333 Market Street, 4th Floor  
 Harrisburg, PA 17126-0333

**Exhibit 7-1      Payments on Account of Pupil Transportation (24 P.S. §25-2541(c))**

(c) *Payments for pupil transportation on account of the school year 1979-1980 and every school year thereafter shall be made only in the following cases:*

(1) *To all school districts for the transportation to and from school of elementary school pupils, including kindergarten pupils, residing one and one-half (1½) miles or more by the nearest public highway from the school in which the pupils are enrolled and to which transportation is authorized under section 1361 of this act or residing in areas where the road or traffic conditions are such that walking constitutes a hazard to the safety of the child **when so certified by the Department of Transportation**. The Department of Transportation shall take into account the presence of sidewalks along the highway, but such presence or lack thereof shall not be controlling and the department shall consider all relevant safety factors in making its determination as to whether or not walking constitutes a hazard to pupils. Such elementary school pupils shall include nonresident children who are placed in the home of a resident, or who are residents of an orphanage, or home or children's home or other institution for the care and training of orphans or other children.*

(2) *To all school districts for the transportation to and from school of secondary school pupils residing two (2) miles or more by the nearest public highway from the school in which the pupils are enrolled and to which transportation is authorized under section 1361 of this act or residing in areas where the road or traffic conditions are such that walking constitutes a hazard to the safety of the child **when so certified by the Department of Transportation**. The Department of Transportation shall take into account the presence of sidewalks along the highway, but such presence or lack thereof shall not be controlling and the department shall consider all relevant safety factors in making its determination as to whether or not walking constitutes a hazard to pupils. Such secondary school pupils shall include nonresident children who are placed in the home of a resident, or who are inmates of an orphan asylum or home or children's home or other institution for the care and training of orphans or other children.*

(3) *To all school districts for pupils transported to and from approved consolidated schools or approved joint consolidated schools living one and one-half (1½) miles or more from the school of attendance or residing in areas where the road or traffic conditions are such that walking constitutes a hazard to the safety of the child **when so certified by the Department of Transportation**. The Department of Transportation shall take into account the presence of sidewalks along the highway. but such presence or lack thereof shall not be controlling and the department shall consider all relevant safety factors in making its determination as to whether or not walking constitutes a hazard to pupils.*

*Consolidated schools or joint consolidated schools shall so long as they are approved as to organization, control, location, equipment, courses of study, qualifications of teachers, methods of instruction, condition of admission, expenditures of money, methods and means of transportation and the contracts providing therefore, constitute approved consolidated schools or approved joint consolidated schools.*

(4) *To all school districts for the transportation of exceptional children regularly enrolled in special classes approved by the Department of Education or enrolled in a regular class in which approved educational provisions are made for them.*

(5) *To all school districts for pupils transported to and from area technical schools.*

## 7.4 Chapter 7 Appendix

**67 Pa. Code §212.501 - School Zone Speed Limits**

Sec.

212.501. [School zone speed limits.](#)

**§212.501. School zone speed limits.**

(a) *Establishment.* A 15 miles per hour school zone speed limit may be established in a school zone during the normal hours that walking students are arriving at or leaving school, under 75 Pa.C.S. §3365(b) (relating to special speed limitations).

(1) To establish a school zone, local authorities shall be responsible to prepare and submit a drawing showing the locations where students walk along or across roadways that are adjacent to school property, the hours that students are going to or from school and the proposed limits for the school zone to the Department for approval.

(2) The Department is responsible for approving the establishment of all school zones, including the locations and hours of operation, except local authorities shall be responsible for approving school zones at the following locations:

(i) On local highways when the municipality has received municipal traffic engineering certification under Chapter 205 (relating to municipal traffic engineering certification).

(ii) On State-designated highways when the municipality has entered into an agreement with the Department thereby transferring to the local authorities the authority to install traffic-control devices without specific Department approval.

(iii) On highways in cities of the first and second class, except not on expressways.

(3) The duration of a 15 miles per hour school zone speed limit should be only long enough to include the time that walking students routinely arrive at or leave school.

(b) *Posting.* A school zone speed limit shall be posted on official traffic-control devices as follows:

(1) At the beginning of the school zone speed limit, one of the following signs or groups of signs shall be posted either on the right side of the roadway or over the roadway:

(i) A Speed Limit Sign (R2-1) with the appropriate school zone speed limit, with a School Panel (S4-3) mounted above the Speed Limit Sign (R2-1) and a When Flashing Sign (S4-4) mounted below the Speed Limit Sign (R2-1), with two flashing speed limit sign beacons.

(ii) A Speed Limit Sign (R2-1) with the appropriate school zone speed limit, with a School Panel (S4-3) mounted above the Speed Limit Sign (R2-1) and a Restricted Hours Panel (R10-20A) mounted below the Speed Limit Sign (R2-1).

(iii) A School Speed Limit When Flashing Sign with a blank-out “15” and flashers as illustrated in the *Traffic Signal Design Handbook* (Department Publication 149).

(2) An End School Zone Sign (S5-2) shall be posted on the right side of the roadway to define the end of the school zone speed limit.

(3) The limits of a school zone may extend beyond the school property lines to improve the sight distance or to encompass a school crosswalk, except that the length of the zone may not be greater than 1,600 feet.



**67 Pa. Code Chapter 447 - Hazardous Walking Routes**

Sec.

- 447.1. [Purpose.](#)
- 447.2. [Definitions.](#)
- 447.3. [General policy.](#)
- 447.4. [Criteria.](#)

**Authority**

The provisions of this Chapter 447 issued under sections 506 and 2001 of The Administrative Code of 1929 (71 P. S. §§186 and 511); and sections 1362 and 2541 of the Public School Code of 1949 (24 P. S. §§13-1362 and 25-2541), unless otherwise noted.

**Source**

The provisions of this Chapter 447 adopted August 1, 1980, effective August 2, 1980, 10 Pa.B. 3191, unless otherwise noted.

**§447.1. Purpose.**

This chapter establishes guidelines for determining if a designated school student walking route along a public highway is hazardous, as the defined term is used in sections 1362 and 2541 of the Public School Code of 1949 (24 P. S. §13-1362 and §25-2541).

**Source**

The provisions of this §447.1 adopted August 1, 1980, effective August 2, 1980, 10 Pa.B. 3191; amended August 7, 1981, effective August 8, 1981, 11 Pa.B. 2777.

**§447.2. Definitions.**

The following words and terms, when used in this chapter, have the following meanings, unless the context clearly indicates otherwise:

*Elementary students*—School students in kindergarten or grades one through six.

*Hazardous*—An unsafe condition caused by potential incompatibility between vehicles and school students, while the students are walking between their home and their school or school bus stop.

*Safe-running speed*—The official speed limit as posted by signs or, in the absence of a posted speed limit, the average speed as determined by making a minimum of five test runs in each direction and periodically recording the operating speed at different locations while driving at a

speed which is reasonable and prudent considering the spacing of intersections, roadside development and sight distance.

*Secondary students*—School students in grades 7 through 12.

*Shoulder*—The portion of the highway contiguous to the roadway used for accommodation of stopped or parked vehicles, for emergency use or for lateral support of base and surface courses.

*Sidewalk*—That portion of a street or highway or other public right-of-way which is reserved exclusively for pedestrian travel and is normally protected by a minimum average 4-inch high, nonmountable curb, or is not immediately adjacent to the roadway. A sidewalk should have a minimum width of 2 feet; a gravel, brick, stone or paved surface; and be available for use during normal weather conditions.

*Student walking route*—The system of streets, shoulders, sidewalks and crosswalks used by school students when walking between their home and their school or school bus stop, officially designated by the school district or, where no official route has been designated, used by school students because of the unavailability of a reasonable alternate route.

#### Source

The provisions of this §447.2 adopted August 1, 1980, effective August 2, 1980, 10 Pa.B. 3191; amended August 7, 1981, effective August 8, 1981, 11 Pa.B. 2777.

#### **§447.3. General policy.**

(a) A request for review of student walking routes should be referred to the appropriate engineering district as listed in Appendix A [NOTE: Appendix A is not included in Publication 46]. Personnel of the engineering district will make the necessary study upon receipt of a written request from a school district and the district engineer will certify whether the route is or is not hazardous. The certification will be forwarded to the school district and to the Department of Education.

(b) The Vehicle Code sets forth certain rights and duties for pedestrians and vehicular traffic. These rights and duties have been considered in the development of these guidelines. Accordingly, if a hazard exists solely because of failure of drivers or school students to obey the provisions of the Vehicle Code, the student walking route may be declared hazardous; however, the basis for the hazardous walking route determination shall be so noted on the certification and the problem brought to the attention of the municipality.

(c) Road and traffic conditions shall be evaluated before any highway or section of highway is declared hazardous. The presence or absence of side walks shall be a factor in the evaluation but may not be the controlling factor. The criteria for road and traffic conditions may apply only to student walking routes, as defined in this chapter.

(d) This chapter may not be construed to require school buses to stop at every dwelling in the event that a student walking route or a portion thereof is declared hazardous, since such a policy would increase the probability of bus-related accidents. A student may be required to walk up to 500 feet on a roadway designated as a hazardous walking route when the route is designated as hazardous in accordance with §447.4(b) (relating to criteria).

(e) If changes occur in the condition of a walking route that was previously inspected, a reevaluation of the route may be requested.

**Source**

The provisions of this §447.3 adopted August 1, 1980, effective August 2, 1980, 10 Pa.B. 3191; amended August 7, 1981, effective August 8, 1981, 11 Pa.B. 2777.

**§447.4. Criteria.**

(a) A student walking route shall be considered hazardous if any one of the following three conditions exist:

(1) Two or more pedestrian-related accidents have occurred during the last 3 years while the pedestrians were walking along the student walking route during hours students are normally going to or from school.

(2) It is necessary for a student to cross a roadway; either daily or intermittently, at a location where vehicular traffic is not controlled by either traffic control signals or a stop sign, or where students are not protected by an adult crossing guard; provided vehicular traffic on roadway is in excess of the values given in the table below for any 15-minute period during which students are enroute to or from school:

**TABLE I**

<i>Roadway Width (ft)*</i>	<i>For Elementary Students Number of Vehicles</i>	<i>For Secondary Students Number of Vehicles</i>
20 or less	155	175
24	130	150
30	100	120
36	80	100
48	40	60

\* If the roadway is divided by a raised median which is at least 8 feet wide and has nonmountable curbs, the roadway should be considered as two separate roadways.

(3) It is necessary for students to cross a railroad-highway grade crossing which has two or more tracks and the following three qualifications are met:

(i) Trains normally — not necessarily with regularity — use the crossing at the time the students cross the tracks going to or from school.

(ii) The crossing is not protected by a flashing light signal or a crossing guard.

(iii) The speed of the trains and the available sight distance are such that students walking at a speed of 3.5 feet per second cannot safely cross the tracks.

(b) A student walking route shall be considered hazardous if a sidewalk does not exist and either paragraph (1) or (2) applies:

(1) The shoulders are less than 4 feet wide and for either:

(i) Elementary students, the roadway surface is less than 20 feet wide and one or more trucks with three or more axles, not including garbage trucks or other types of trucks making house-to-house stops, normally use the roadway during the time the elementary students are enroute to or from school.

(ii) Streets and highways with an average traffic volume of at least ten vehicles per hour during the time students are walking, a 3.5-foot tall elementary school student or a 4.5-foot tall secondary student is not visible by approaching drivers from at least the following minimum distances:

**TABLE II**

<i>Safe-running Speed</i>	<i>Minimum Distance (ft.)</i>
30 or less	200
35	240
40	275
45	315
50	350
55	410

(2) The normal vehicular traffic volume during any 15-minute period that students are enroute to or from school exceeds the following values for the appropriate safe-running speed range:

(i) Safe-running speed is 35 mph or less:

<i>Shoulder Width</i>	<i>For Elementary Students</i>	<i>Number of Vehicles For Secondary Students Only</i>
less than 4 ft.	30	45
4 ft. – 6 ft.	60	100

(ii) Safe-running speed is over 35 mph:

<i>Shoulder Width</i>	<i>For Elementary Students</i>	<i>Number of Vehicles For Secondary Students Only</i>
less than 4 ft.	20	30
4 ft. – 6 ft.	40	65

**Source**

The provisions of this §447.4 adopted August 1, 1980, effective August 2, 1980, 10 Pa.B. 3191; amended August 7, 1981, effective August 8, 1981, 11 Pa.B. 2777.

**Cross References**

This section cited in 67 Pa. Code §447.3 (relating to general policy).

**Student-Walking Route - Study and Data Sheet**

County \_\_\_\_\_ Municipality \_\_\_\_\_

School District Name \_\_\_\_\_ IU \_\_\_\_\_

Address: \_\_\_\_\_

\_\_\_\_\_ Zip Code \_\_\_\_\_

**FOR PURPOSES OF THIS REVIEW, THE FOLLOWING DEFINITIONS APPLY:**

**Elementary students** – School students in kindergarten or grades one through six.

**Hazardous** – An unsafe condition caused by potential incompatibility between vehicles and school students, while the students are walking between their home and their school or school bus stop.

**Safe-running speed** – The official speed limit as posted by signs or, in the absence of a posted speed limit, the average speed as determined by making a minimum of five test runs in each direction and periodically recording the operating speed at different locations while driving at a speed which is reasonable and prudent considering the spacing of intersections, roadside development and sight distance.

**Secondary students** – School students in grades 7 through 12.

**Shoulder** – The portion of the highway contiguous to the roadway used for accommodation of stopped or parked vehicles, for emergency use or for lateral support of base and surface courses.

**Sidewalk** – That portion of a street or highway or other public right-of-way that is reserved exclusively for pedestrian travel and is normally protected by a minimum average 4-inch high, non-mountable curb, or is not immediately adjacent to the roadway. A sidewalk should have a minimum width of 2 feet; a gravel, brick, stone or paved surface; and be available for use during normal weather conditions.

**Student-walking route** – The system of streets, shoulders, sidewalks and crosswalks used by school students when walking between their homes and their school or school bus stop, officially designated by the school district or, where no official route has been designated, used by school students because of the unavailability of a reasonable alternate route.

**PLEASE NOTE:** A map or detailed sketch of the area must accompany this study and data sheet, highlighting the school student-walking route. This map or detailed sketch should be large enough to include nearby streets and roadways, and should show the location of all adult crossing guards. Also, provide any additional supporting data.

1. Location of school student-walking route: \_\_\_\_\_  
\_\_\_\_\_  
\_\_\_\_\_

2. Local street name, Township Road No., or State Route No. \_\_\_\_\_  
\_\_\_\_\_

Beginning location \_\_\_\_\_

Ending location \_\_\_\_\_

Approximate length \_\_\_\_\_

Any general comments regarding the location: \_\_\_\_\_

3. Typical roadway width is \_\_\_\_\_ feet. Shoulder width is \_\_\_\_\_ feet.

4. Are sidewalks present? \_\_\_\_\_ Are shoulders present? \_\_\_\_\_

5. Is this a request for a re-evaluation of a previously inspected route? \_\_\_\_\_ If  
yes, when was it last reviewed and what was the finding? \_\_\_\_\_  
\_\_\_\_\_

6. During what time periods are students using the subject route?

Elementary Students

Secondary Students

(a) Morning \_\_\_\_\_ to \_\_\_\_\_

(a) Morning \_\_\_\_\_ to \_\_\_\_\_

(b) Mid-day \_\_\_\_\_ to \_\_\_\_\_

(b) Mid-day \_\_\_\_\_ to \_\_\_\_\_

(c) Afternoon \_\_\_\_\_ to \_\_\_\_\_ (c) Afternoon \_\_\_\_\_ to \_\_\_\_\_

7. Which 15-minute time period has the greatest vehicular traffic volume while:

(a) Elementary students are enroute?

\_\_\_\_\_ to \_\_\_\_\_ 15-minute volume: \_\_\_\_\_

(b) Secondary students are enroute?

\_\_\_\_\_ to \_\_\_\_\_ 15-minute volume: \_\_\_\_\_

8. How many pedestrian-related accidents occurred in the study area in the last 36 months during the hours students are normally going to or from school? \_\_\_\_\_

*(If any pedestrian accidents occurred, please attach a copy of each police accident report and indicate the location of the accident on the accompanying map. The walking route between two or more accident locations is hazardous.)*

9. Does the student-walking route cross the roadway at any location where vehicular traffic is not controlled by either a STOP sign or traffic-control signal, or an adult crossing guard?

\_\_\_\_\_ If yes, what is the roadway width? \_\_\_\_\_ and, is the crossing by:

(a) Elementary students? \_\_\_\_\_ Secondary students? \_\_\_\_\_

(b) Number of vehicles using the road during a 15-minute period while students would ordinarily be attempting to cross the road? \_\_\_\_\_

*(If the number of vehicles exceeds the appropriate values in Table 1 in §447.4(a)(2) of the regulations, the crossing is hazardous.)*

10. Does the student-walking route cross a highway-rail grade crossing that has two or more tracks? \_\_\_\_\_ If yes,

(a) Do trains normally use the crossing during the time students are going to or from school? \_\_\_\_\_



(b) Is the crossing unprotected? \_\_\_\_\_ Question (b) is answered "no" when:

- A flashing light signal (i.e., two alternately flashing red light units) is installed at the crossing, or
- A "flagger is employed by the railroad company to stop highway vehicles and pedestrians, is present whenever a train moves over the crossing.

(c) Is the speed of the trains and the available sight distance such that students walking at a speed a normal pace of approximately 3.5 feet per second cannot safely cross the tracks? \_\_\_\_\_

*(If the answers to all four questions are "yes," crossing the rail-highway grade crossing is hazardous.)*

11. Is the roadway less than 20 feet wide and without either sidewalks or minimum 4-foot wide shoulders at any location? \_\_\_\_\_ If yes, how many trucks with three or more axles (excluding garbage trucks or other types of trucks making house-to-house stops) normally use the roadway during the time elementary students are enroute? \_\_\_\_\_

*(If the first answer is "yes," and one or more trucks normally uses the roadway during this time, the section of highway or street on which the trucks travel is hazardous.)*

12. What is the safe running speed (see the definition on Page 7C-1)? \_\_\_\_\_ mph.

13. Do at least 10 vehicles use the roadway during the hours students are going to or from school, and is the roadway without either sidewalks or minimum 4-foot wide shoulders at any location? \_\_\_\_\_ If yes, are there any sections of the roadway where the visibility of the student(s) is a problem for approaching drivers? \_\_\_\_\_ If yes, how far away can drivers see the shortest student? \_\_\_\_\_ feet.

*(If the distance is less than the appropriate value in Table II in §447.4(b)(ii) of the regulation, the section of street or highway on which the sight distance deficiency exists is hazardous.)*

14. If the roadway has no sidewalks, how wide are the shoulders? \_\_\_\_\_ feet During any 15-minute period that students are enroute to or from school, how many vehicles normally travel on the roadway? \_\_\_\_\_

*(If the number of vehicles exceeds the values in §447.4(b)(2) for the appropriate speed, the route is hazardous for elementary and secondary students.)*

15. Do elementary students have to cross at a signalized intersection that does not have an exclusive pedestrian walk phase or an adult crossing guard? \_\_\_\_\_ If yes, is sight distance, traffic volumes, or roadway widths such that it may be difficult for an elementary student to cross the intersection safely? \_\_\_\_\_

*(If both answers are "yes" the route is hazardous for elementary students.)*

16. Do secondary students who use the student-walking route have to cross a signalized intersection which is not routinely protected by an adult crossing guard? \_\_\_\_\_ If yes, is one or more of the following is satisfied? \_\_\_\_\_

- Students cannot readily see visible signal indications when desiring to cross the intersection.
- The signal is a multi-phase operation where it may not be apparent what traffic has a green indication.
- A 4.5-foot tall student using a crosswalk within the intersection may not be visible at a point that will allow an approaching driver turning through the crosswalk time to come to a safe stop.
- The complexity of the geometrics of the intersection makes it difficult for a secondary school student to traverse the intersection or reach a safe refuge.

*(If both answers are "yes" the route is hazardous for secondary students.)*

17. Can the school bus stop or the student-walking route be relocated to avoid a hazardous certification? \_\_\_\_\_  
 \_\_\_\_\_

18. Are there any other extenuating circumstances that you believe would qualify this route as being hazardous? \_\_\_\_\_

\_\_\_\_\_

\_\_\_\_\_

\_\_\_\_\_

PERSON RESPONSIBLE FOR COMPLETING THIS FORM:

I hereby certify that I personally examined this student-walking route and, to the best of my knowledge, the information I have supplied on this Study and Data Sheet is true and correct.

Name \_\_\_\_\_

Signature \_\_\_\_\_ Date \_\_\_\_\_ Title \_\_\_\_\_

\_\_\_\_\_ Telephone No. \_\_\_\_\_

SCHOOL SUPERINTENDENT:

Signature \_\_\_\_\_ Date \_\_\_\_\_

Student Walking Route Certification

On \_\_\_\_\_, the Pennsylvania Department of Transportation
(Date)
investigated \_\_\_\_\_, in Intermediate Unit No. \_\_\_\_\_,
(SR, or Road or Street)
\_\_\_\_\_ School District, between \_\_\_\_\_
\_\_\_\_\_ and \_\_\_\_\_
\_\_\_\_\_, in \_\_\_\_\_ County.

The results of the investigation indicate the following:

Multiple horizontal lines provided for writing the results of the investigation.

Certified by:

District Executive
Engineering District \_\_\_\_\_

## CHAPTER 8 - HIGHWAY-RAIL GRADE CROSSINGS

### 8.1 General

#### Purpose

Highway-rail grade crossings differ from a highway-highway intersection in that the train always has the right-of-way. Therefore, considering the disastrous nature of crashes that occur when a highway vehicle gets hit by a train, it is extremely important that everyone comply with requirements of Publication 371 and the *MUTCD*, FHWA's *Railroad-Highway Grade Crossing Manual*, and other national guidelines.

The Public Utility Commission (PUC) is vested with exclusive jurisdiction to determine and prescribe the manner in which, highway-railroad crossings may be constructed, altered, relocated, suspended, or abolished, and the manner and conditions in or under which such crossings shall be maintained, operated, and protected to effectuate the prevention of crashes and the promotion of the safety of the public. The PUC is also authorized to appropriate property for construction or alteration of crossings, to allocate costs, and to assign maintenance to any party under its jurisdiction. See 66 Pa. C.S., Chapter 27, §§2702 and 2704.

#### Laws, Regulations and Other Publications

[Grade Crossing Manual](#), PennDOT Publication 371, latest edition.

[Guidance on Traffic Control Devices at Highway-Rail Grade Crossings](#). This is a collaboration of research and accepted practices, published by the U.S. DOT, Highway-Rail Grade Crossing Technical Working Group (TWG).

[Manual on Uniform Traffic Control Devices \(MUTCD\)](#). FHWA's manual that establishes national guidelines for traffic-control devices. Specifically, Part 8 addresses highway-rail grade crossings.

[Official Traffic-Control Devices \(Publication 212\)](#). Regulations published as 67 Pa. Code Chapter 212. This regulation adopts the Federal Highway Administration's *Manual on Uniform Traffic Control Devices (MUTCD)* and establishes additional study requirements, warrants, principles and guidelines not included in the MUTCD.

[Traffic Control -- Pavement Markings and Signing Standards](#). This is PennDOT Publication 111. Specifically, the TC-8600 standard prescribes the pavement markings at highway-rail grade crossings.

[Railroad-Highway Grade Crossing Handbook](#), Revised Second Edition, August 2007, Publication No. FHWA-SA-07-010.

#### Definitions

The following words and terms, when used in this policy shall have the following meanings, unless the context clearly indicates otherwise:

**Abandonment of a rail line** – This occurs when the Railroad files with the Surface Transportation Board (STB) and through a hearing process ask to give up their rights to serve customers.

**Abolishment of an at-grade crossing** – This typically occurs when abandonment of a rail has occurred for which at-grade crossings exist. Once the crossing has been ordered by the PUC to be abolished, all passive and active warning devices are to be removed and the crossing surface can either be paved over or totally removed from the roadway. Once a crossing has been abolished the PUC has no further jurisdiction over said crossing.

*Exempt signs* – The Exempt Railroad Crossing (R15-3) sign and the Exempt Railroad Warning (W10-1A) sign shall be authorized for use at those railroad grade crossings having “exempt” status as determined by the PUC. The PUC can order Exempt signs to be installed should the railroad wish not to suspend a crossing, but agrees to stop and flag the crossing due to very minimal rail traffic (e.g., seasonal rail traffic, less than one train per week during daylight hours, rail traffic is suspended for an extended length of time, etc.). Placement of “Exempt” signs below the crossbucks and the advance warning signs allows school buses, trucks carrying hazardous material, and vehicles carrying passengers for hire (commuter buses) to cross without stopping.

*Suspension of an at-grade crossing* – This typically occurs when the rail line has not been abandoned and the railroad concurs with suspending the crossing because there is not current or immediate future rail service for the line. A suspended crossing involves the removal of the traffic control devices (crossbucks and advance warning signs), and crossing gates if they exist, and the flashing lights can either be removed, turned away from view, or hooded. Until the rail lines are either removed or paved over the TRACKS OUT OF SERVICE (R8-9) sign shall be installed. Once the crossing is paved over, removed, or rail line is placed back in service this sign shall be removed. The Public Utility Commission (PUC) has jurisdiction over suspended crossings, meaning that no alterations can occur without proper PUC approval.

## 8.2 Miscellaneous Provisions

### Abandoned Railroad Grade Crossings

[§3342\(c\)\(4\)](#) of the Vehicle Code (relating to abandoned railroad crossings) requires that abandoned railroad grade crossings be marked by the former rail operator with a sign prescribed by the Department indicating that the rail line is abandoned. The appropriate sign for this application is the TRACKS OUT OF SERVICE (R8-9) sign.

### Placement of the Advance Warning Sign

The Highway-Rail Grade Crossing Advance Warning (W10-1) sign (or any of the W10-series signs) shall be used on each highway approach in advance of every highway-rail grade crossing except as noted in Section 8B.04 of the *MUTCD*.

Note 22 on Sheet 3 of 8 of the Pavement Marking Standards (TC-8600), provides guidance on the location of the advance railroad warning sign (i.e., dimension “C”). The values in the standard are greater than the “0-mph” values for Condition B in Table 2C-4 of the *MUTCD*, and should be used to help compensate for the following:

1. The advance distances in the *MUTCD* uses the assumption that drivers have a 2.5-second reaction time, and then will use their brakes to decelerate at a rate of 11.2 feet/second<sup>2</sup>. For example, on a 55-mph road, the advance distance for the warning sign in the *MUTCD* would be 325 feet, whereas the TC-7800 standard now uses 450 feet. Since queuing may occur at the crossing, the Department believes it is prudent to use larger values.
2. Research suggests that the current rule-of-thumb for legibility distance should be reduced from 40 feet to 30 feet per inch of legend height to more accurately conform to minimum eyesight requirements for some state driver licensing. Therefore, it is likely that the values in Table 2C-4 of the *MUTCD* may be increased in the near future.

It is important to note that these are minimum distances and they are measured from the stop bar and not the railroad track.

## Pavement Markings

In accordance with Section 8B.20 and Figure 8B-6 of the *MUTCD*, railroad crossing pavement markings are to be placed in advance of the highway-rail grade crossing unless the posted/statutory highway speed is less than 40 mph, or in an urban area, if an engineering study indicates that the other installed devices provide suitable warning and control. The stop line, which shall be placed on each approach to a highway-rail grade crossing, is to be placed no closer than 15 feet from the nearest rail. On multilane highways, the stop line shall traverse across all approach lanes and individual RXR symbols should be placed in each approach lane.

## Maintenance Responsibilities

The ordering of the installation and future maintenance responsibilities for passive warning devices, advance warning signs, and railroad crossing pavement markings at public at-grade crossings are under the jurisdiction and approval of the PUC. With regards to maintenance:

- The railroad is responsible for the passive warning devices at the crossing, i.e., Railroad Crossbuck (R15-1), Tracks (R15-2), Exempt Railroad Crossing (R15-3), Emergency Notification, and TRACKS OUT OF SERVICE (R8-9) signs, and any signs attached to the flashing light supports masts/cantilevers.
- The road owner is responsible for the advance warning (W10-series) and Exempt Railroad Warning (W10-1A) signs, and railroad crossing pavement markings (including the stop bar).

Typically the installation of such warning devices would be the same party responsible for the future maintenance. The PUC will include in their PUC Orders the parties responsible for maintaining the active and passive warning devices, advance warnings signs, and pavement markings; and that the installation of such be in accordance with Part 8 of the *MUTCD*.

## Retroreflective Strips on Crossbuck Signs and Supports

The *MUTCD* has established a compliance date of January 17, 2011 (see Page I-6 in the 2003 Edition) for the installation of retroreflective sheeting material in compliance with Section 8B.03. Specifically, a minimum 2-inch wide strip of retroreflective sheeting material is required as follows:

1. On the back of each blade of each Crossbuck (R15-1) sign for the length of each blade except when the R15-1 sign is installed back-to-back.
2. On each support at passive highway-rail grade crossings for the full length of the front and back of the support from the Crossbuck (R15-1) sign or the Number of Tracks (R15-2) sign to within 2 feet above the elevation of the edge of roadway, except on the side where a STOP sign or YIELD sign have been installed or on the backside of the support on a one-way street.

In 2004, PennDOT initiated a limited-time program using railroad safety funds, to reimburse railroad companies a statewide fixed unit price to add retroreflective strips to their crossbucks and supports.

The program also used fixed unit prices for the installation of Emergency Notification Signs as discussed in Section 8B.12 of the *MUTCD*.

The railroad company is responsible to provide and maintain the Crossbuck (R15-1) sign and the retroreflective strips on the R15-1 signs and their supports. In light of the January 17, 2011 deadline, if Districts are aware that the retroreflective strips are not in place, they should remind the appropriate railroad company of their responsibilities.

## CHAPTER 9 - BICYCLE FACILITIES

### 9.1 General

#### Purpose

The purpose of this chapter is to supplement Part 9 of the *MUTCD* by providing additional policies designed to enhance bicycle travel within the Commonwealth.

#### Integration of Bicycle Travel into the Planning and Design Process

Department policy now requires the evaluation of the access and mobility needs of pedestrians and bicycle users in all highway and bridge transportation corridors. This revised policy mandates that highway and bridge projects must evaluate the existing, latent, and projected needs of pedestrians and bicycle users. It requires the integration of the identified needs into project planning and design processes. This revised policy also clarifies that bicycle users are vehicles and that bicyclists and pedestrians are traffic in accordance with the Vehicle Code, and bolsters the importance of pedestrians and bicycle travel as viable and connective modes of transportation.

This Department policy is in SOL No. 432-07-02 (subject is “Integration of Pedestrian and Bicycle Modes of Transportation into Planning and Design Processes”) and will be in Design Manuals 1 and 1A. The primary evaluation tool of access and mobility needs of pedestrians and bicycle users is the “Bicycle and Pedestrian Checklist,” which will be in Design Manual 1A, Appendix J, with supporting documentation in Appendix A.

#### Laws, Regulations and Other Publications

*AASHTO Guide for the Development of Bicycle Facilities*, American Association of State Highway and Transportation Officials (AASHTO), ISBN 1-56051-102-8, 1999. Available at <http://azbikelaw.org/blog/aashto-guide-for-the-development-of-bicycle-facilities/>.

*Americans with Disabilities Act and Architectural Barriers Act Accessibility Guidelines*, United States Access Board, July 23, 2004. Available at <http://www.access-board.gov/ada-aba/final.pdf>.

*Design Manual, Parts 1, 1A and 2*, PennDOT Publications 10, 10A and 13M. See <ftp://ftp.dot.state.pa.us/public/PubsForms/Publications/PUB%2012.pdf>.

*Manual on Uniform Traffic Control Devices (MUTCD)*, FHWA. Specifically, Part 9 addresses traffic control devices for bicycle facilities and is available at <http://mutcd.fhwa.dot.gov/>.

*Standards for Roadway Construction*, PennDOT Pub. 72M, June 2010. These standard drawings are for common highway features, and are available at <ftp://ftp.dot.state.pa.us/public/Bureaus/design/PUB72M/PUB72COV.pdf>.

*Vehicle Code (75 Pa.C.S.)*. Title 75 of the Pennsylvania Consolidated Statutes, which sets forth the laws relative to travel on streets and highways, and specific actions required by the Department. Of specific importance, §§3501 through 3513 address the operation of pedalcycles – and is available at [http://www.dmv.state.pa.us/pdotforms/vehicle\\_code/chapter35.pdf](http://www.dmv.state.pa.us/pdotforms/vehicle_code/chapter35.pdf)

#### Definitions

The following word, when used in this chapter, shall have the following meaning, unless the context clearly indicates otherwise:



---

*Freeway* – A limited access highway to which the only means of ingress and egress is by interchange ramps.

## 9.2 Bicycle Routes

### BicyclePA Routes

The PA Pedalcycle and Pedestrian Advisory Committee and PennDOT jointly developed various cross-state designated bicycle routes that are referenced as “BicyclePA Routes.”

When erecting signs for these routes, every turn is to have a BicyclePA Route Marker Turn Assembly (M1-8A) and a confirmation BicyclePA Route Marker (M1-8) in each direction of travel. Also, install the M1-8 markers at distances of approximately 3 to 5 miles along the route, including beyond major intersections, so that bicyclists approaching the route will recognize that they have intersected it.

## 9.3 Miscellaneous Provisions

### Bicycles on Freeways

In 1992, §3511 was added to the Vehicle Code (relating to pedalcycles prohibited on freeways) to prohibit pedalcycles on freeways except through the establishment of a permit process.

Considerations for possible approval:

1. Length of an alternate route versus distance on freeway.
2. Absence of potentially hazardous conditions on an alternate route, including but not limited to the following:
  - ADT of 500 or greater
  - Speed limit of 35 mph or higher
  - Poor pavement condition
  - Driveways
  - Intersections
  - Narrow or unpaved shoulders
  - Narrow vehicular travel lanes
  - Pedestrian traffic
  - Presence of railroad tracks, especially skewed crossings
  - Narrow bridges
  - Poor sight distance
  - Parked vehicles
  - Turning trucks
  - High percentage of trucks, buses, and recreational vehicles
3. Freeway has continuous paved shoulders of sufficient width and acceptable quality to accommodate bicycles (absence of rumble strips).

Application approval process:

1. The applicant completes an application (see the [Chapter 9 Appendix](#) on page 9-5) and submits it to the Central Office Bicycle/Pedestrian Coordinator, who redistributes it to the District Bicycle/Pedestrian Coordinator for review.
2. The Engineering District verifies that the road in question is a freeway as defined herein. If it is a freeway, the District Bicycle/Pedestrian Coordinator and representatives from the District Traffic and Maintenance Units (Plans Unit is optional) should then field view the roads in question. As a minimum, the field view should determine:
  - a) Alternatives – length, condition, geometrics, etc.
  - b) Freeway section – condition, shoulder type, width, shoulder condition (pavement integrity).

The Engineering District should make every reasonable attempt to work with the applicant to solicit all pertinent information so that the Department can make a well-informed decision. Judge each application on a case-by-case basis.

3. Within 45 days after receipt of the application, the District should make one of the following recommendations to the Central Office Bicycle/Pedestrian Coordinator:
  - a) Approve. There are no reasonable route available based on length or safety, and the shoulder can be used as a designated bikeway.
  - b) Approve in part. Section of requested route meets criteria, and an alternate route may satisfy the remainder.
  - c) Disapprove.
    - i. Requested route cannot safely accommodate bicycles (e.g., the shoulder may be too narrow or its condition may be of such poor quality that it cannot accommodate bicycles).
    - ii. An alternate route is available that is relatively safe and presents only minimal added distance and terrain requirements.
    - iii. Insufficient information, e.g., additional information must be provided before a decision can be rendered.
4. The Bureau of Maintenance and Operations (BOMO) will then make a final recommendation. If the recommendation is to approve the request or part of the request, BOMO will prepare a notice of any proposed approval for publication in the *Pennsylvania Bulletin* and submit it to the Deputy Secretary for Highway Administration for approval.
5. If the Secretary or Deputy Secretary approves the request, the notice is published in the *Pennsylvania Bulletin* and the freeway section is open to any pedalcyclist who is 18 years of age or older, or is accompanied by a pedalcyclist who is 18 years of age or older.
6. The applicant is notified in writing after a decision is rendered. If any part of the request is denied, the applicant may submit a request in writing within 20 days to the Administrative Docket Clerk, Office of Chief Counsel, 9th Floor, Commonwealth Keystone Building, 400 North Street, Harrisburg, PA 17120. The applicant will pay a minimum \$100 fee for reconsideration.
7. If any part of the request to use a freeway is approved, the District will have the following traffic signs installed at the locations indicated on the sign standard:

- MOTOR VEHICLES AND BICYCLES ONLY (R5-3-1A)
- BICYCLES MUST USE SHOULDER (R5-3-1B)
- ALL BICYCLES MUST EXIT (R5-3-1C)
- Bicycle Restrictions (R5-3-1D)

### **Longitudinal Rumble Strips**

The purpose of installing longitudinal rumble strips is to alert drowsy and inattentive motor vehicle drivers, but the standard type as included in the RC-25M Standard, Sheets 4 and 5 may pose a control threat to bicyclists who may inadvertently steer into them.

Therefore, Districts are encouraged to either use edgeline rumble strips (ELRS) or bicycle tolerable shoulder rumble strips (BTSRS) as discussed in Publication 638, instead of the standard rumble strips addressed in the RC-25M Standard.

## 9.4 Chapter 9 Appendix

**Request to Operate a Pedalcycle on a Freeway**

Name \_\_\_\_\_

Organization \_\_\_\_\_ Address \_\_\_\_\_

\_\_\_\_\_  
\_\_\_\_\_  
Daytime \_\_\_\_\_

Phone No. (\_\_\_\_) \_\_\_\_\_

Section of Freeway Requested for Use (Reference by interchange name or number on freeway or intersecting traffic route or interchange name:

From \_\_\_\_\_  
\_\_\_\_\_

To \_\_\_\_\_  
\_\_\_\_\_

Reasons Why an Alternate Route is Not Suitable (Consider length and safety considerations of alternate route. Use continuation sheets, if necessary. Attach maps, photographs, and other documentation, if appropriate):

\_\_\_\_\_  
\_\_\_\_\_  
\_\_\_\_\_  
\_\_\_\_\_  
\_\_\_\_\_  
\_\_\_\_\_  
\_\_\_\_\_

**NOTE:** Return the completed form to: PennDOT Bicycle/Pedestrian Coordinator, Bureau of Maintenance and Operations, P.O. Box 2047, Harrisburg, PA 17105-2047. Telephone No. (717) 783-8444

## CHAPTER 10 - HIGHWAY CAPACITY MANUAL AND DATA COLLECTION PARAMETERS

### 10.1 General

#### Purpose

In April 2011, the Transportation Research Board (TRB) released the 2010 Highway Capacity Manual (HCM2010). This fifth edition contains major revisions as compared with previous years, and it synthesizes the latest research on highway capacity and quality of service. Much of the subject matter addressed within this chapter is also covered in depth by many national resources, including but not limited to the [HCM2010](#), the Federal Highway Administration's [Traffic Analysis Toolbox](#), and the Institute of Transportation Engineer's [Manual of Transportation Engineering Studies, 2nd Edition](#).

This chapter will provide the following recommendations and guidance:

- Identify and provide guidance on how to collect key traffic study parameters that are used within the HCM2010 in order to accurately conduct a traffic analysis;
- Evaluate the context of a project and select the appropriate analysis tool category;
- Provide supplemental direction on the use of the HCM2010;
- Provide Pennsylvania-specific default values for some key parameters;
- Provide direction on when to consider multimodal analysis;
- Provide direction when selecting an alternative analysis tool, such as microsimulation software; and
- Provide direction on traffic analysis tool calibration and validation.

#### Engineering Judgment

Similar to other declarations throughout Publication 46, the exercise of sound engineering judgment is a critical component in the preparation and review of traffic studies. In the course of using various parts of this chapter, engineers and planners who specialize in traffic operations, analysis, and modeling should utilize their professional judgment while recognizing the strengths, weaknesses, limitations, and requirements for a myriad of traffic analysis tools and commercial software packages, including the use of the HCM2010, review of the collection and application of various traffic study parameters, calibration and validation work, and the complexities associated with traffic analysis tool selection.

With the guidance provided in this Chapter and the varied analytical needs of projects, analysts should consider multiple references in addition to those listed earlier in this section and throughout this Chapter, including but not limited to manuals and procedures offered by software vendors, guidance and best practices published by the Institute of Transportation Engineers, and other reference documents available to the practice.

## 10.2 Traffic Study Parameters

### Overview

Accurate and well-collected data are the building blocks for a variety of traffic analysis projects. This section provides guidance for the collection and calculation of some common parameters used by a variety of traffic study projects. The goal of this section is to provide consistent guidance when performing traffic analysis work for projects under the purview of the Department. The traffic study parameters to be collected and/or calculated would vary by project and should be discussed and verified by PennDOT prior to commencing work and performing data collection activities.

### Traffic Volumes

A traffic study project should identify the desired analysis time periods, the methods by which peak hour volumes are calculated (i.e., by intersection, by approach, by movement, by system, by roadway, etc.), and the most appropriate methods for collecting field data. Typically, traffic counts manually collected or using automatic methods should be compiled in 15-minute intervals under current conditions that represent the appropriate analysis period. Items to consider prior to performing an automated and/or manual count include:

- Establishment of a data collection plan prior to going to the field. The data collection plan should clearly identify each facility, location of the data collector(s), traffic movements, lane designations, and traffic information needed for the traffic study;
- Identification and calibration of the appropriate automated and manual data collection equipment needed for the traffic study. For potential calibration of traffic data collection equipment, please refer to the manufacturer's instructions; and
- Verify that all data collectors understand and accurately collect the traffic information as required by the traffic study. Training should be provided to new and/or less experienced data collectors to ensure they are collecting the data in a safe and efficient manner. In addition to the information provided within this section, refer to the Institute of Transportation Engineer's [Manual of Transportation Engineering Studies, 2nd Edition](#) for additional guidance on the collection of traffic volume data for various projects.

### Manual Counts

Manual counts involve the collection and organization of traffic volumes at intersections or other points of interest, including roadway segments, which are conducted over a specified duration of time. A variety of traffic counting equipment and technologies are available, including hand-held count boards, computers, smart phone applications, manual tally sheets, and video equipment. Since human error is likely with manual counts, it is recommended that if alternative data (collected by automated and/or manual methods) is also available within the study area, then the degree to which human error has affected results should be addressed. After evaluating the manual data collection efforts, engineering judgment should be used when considering any adjustments to field-collected data. Such adjustments should be documented. Exhibit 10-1 provides an image of a typical handheld count board.

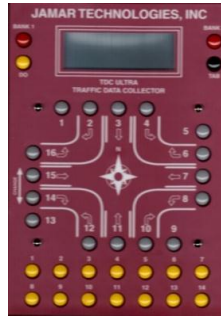
**Exhibit 10-1 Typical Handheld Count Board**

Source: JAMAR TECHNOLOGIES, INC.

When collecting manual counts, the following items should be considered:

- Manual Counts should be collected and binned in 15-minute intervals. Counts should be collected for a minimum of two continuous hours for each peak period. Additional hours of data collection may be considered depending on the traffic study. As an option, sample or spot counts for shorter durations of 15 minutes to 30 minutes may also be permitted; however, this should be avoided whenever possible since most counts require more data.
- Counts should be collected on a typical weekday (average Tuesday, Wednesday, and/or Thursday) under weather conditions that may be considered fair or reasonable, such that travel patterns and/or activity within the area of study are not adversely impacted. If alternative time periods are being considered, please coordinate with the appropriate District Traffic Engineer prior to data collection.
- Engineering Judgment should be used to determine the most appropriate time of year and day or days of week during which to conduct a traffic count (i.e. if a traffic count is near a school then traffic counts should be completed when school is in session.). Seasonal adjustments can also be used if reviewed and approved by the appropriate District Traffic Engineer.
- 12-hour manual turning movement counts are recommended when evaluating traffic signal warrants.
- The number of field personnel should be decided and agreed upon on a project-basis, and for counts of longer durations or complexity, additional field personnel should be considered.
- Counts should separate passenger vehicles and heavy vehicles by movement. It may also be desirable to separate truck, bus traffic, or other special vehicles by movement. Vehicle classifications should be completed according to the [FHWA 13-vehicle class system](#), and the exact vehicle types that could be combined and considered as heavy vehicles should be determined as part of the project's data collection plan. Generally, the number or percentage of heavy vehicles should be based on the larger vehicles that require greater headways, which are typically vehicle types 4 through 13 according to the [FHWA 13-vehicle class system](#).
- Each manual count should include notes that accompany the collection worksheets detailing the operational issues and/or additional conditions observed during data collection.
- At the completion of a 15-minute count window, where practical, the traffic queues should be documented on the data collection worksheet.



- Pedestrians should be counted by approach or relative to a subject crossing. To the extent possible, and if required by the project, the number of pedestrians should be recorded by direction as they enter the crossing and/or remain on the sidewalk.
- Bicyclists traveling in a dedicated bicycle facility or along a shoulder, as well as those sharing the road should be counted by approach and tiered separately.
- Additional data items may also be needed for analysis work later in a project and should be collected simultaneously with the count, including but not limited to parking maneuvers, bus blockages, transit activity (stops, passenger activity), right turns on red, and signal pre-emption by emergency vehicles.
- Additional counts upstream of queue extents may be necessary to derive actual demand volumes.
- Field personnel should be safely located outside of the traveled way with a clear and unobstructed view of the surveyed location.

**Automatic Counts**

Automatic Counts are typically used to record data for an extended period of time and automatically derive volume or other data. Although the use of automatic counts removes human error, occasional equipment and software failures may hinder a count. Automatic Counts are typically used for planning and operational analysis work to first identify and/or classify the distribution of roadway traffic over a select period of time. This is particularly helpful when trying to identify the peak periods to perform manual counts.

**Exhibit 10-2 Typical Automatic Count Data**

Start Time	Mon 14 Mar 05	Tue	Wed	Thu	Fri	Average Day	Sat	Sun	Week Average
12:00 AM	*	674	702	692	793	715	562	480	650
01:00 AM	*	530	563	609	648	588	440	318	518
02:00 AM	*	506	550	575	553	546	454	374	502
03:00 AM	*	486	604	656	583	582	328	219	479
04:00 AM	*	614	656	693	678	660	381	251	546
05:00 AM	*	919	968	887	957	933	541	298	762
06:00 AM	*	1751	1855	1810	1693	1777	771	401	1380
07:00 AM	*	2511	2513	2514	2437	2494	1013	574	1927
08:00 AM	*	<b>2531</b>	<b>2583</b>	<b>2547</b>	<b>2517</b>	<b>2544</b>	1295	799	<b>2045</b>
09:00 AM	*	2158	2108	2190	2146	2150	1512	1094	1868
10:00 AM	*	2003	2074	2062	2018	2039	1699	1345	1867
11:00 AM	*	2009	2152	2167	2229	2139	<b>1898</b>	<b>1588</b>	2007
12:00 PM	*	2109	2123	2065	2333	2158	1931	1752	2052
01:00 PM	*	2088	2291	2153	2376	2227	1826	1996	2120
02:00 PM	*	232	2354	2394	2494	2381	1934	2213	2278
03:00 PM	*	2547	2710	2446	2518	2555	1907	2116	2374
04:00 PM	*	<b>2714</b>	<b>2869</b>	<b>2920</b>	<b>2886</b>	<b>2847</b>	<b>2133</b>	<b>2372</b>	<b>2649</b>
05:00 PM	*	2566	2367	2821	2780	2634	1814	2241	2432
06:00 PM	<b>1739</b>	1994	1873	2069	2114	1958	1690	1892	1910
07:00 PM	1474	1556	1534	1594	1803	1592	1408	1539	1558
08:00 PM	1297	1352	1425	1445	1386	1381	1055	1318	1325
09:00 PM	1209	1139	1337	1237	884	1161	1005	1218	1147
10:00 PM	934	971	1206	1028	1522	1132	1028	1005	1099
11:00 PM	865	853	1644	852	864	1022	748	854	959
Total	7518	38873	41061	40444	41212	40215	29373	28247	36454

When collecting automatic counts, the following items should be considered:

- Automatic Counts should be collected and binned in 15-minute intervals.
- Preferably, automatic counts should be collected for a minimum of seven consecutive days during a typical one-week, non-holiday period during weather conditions that may be considered fair or reasonable, such that travel patterns and/or activity within the area of study are not adversely impacted. If alternative time periods are being considered, please coordinate with the appropriate District Traffic Engineer prior to data collection. Automatic counts of shorter durations for at least two consecutive days may also be permitted; however, this should be avoided due in part to the daily variability in traffic volumes and the need to consider multiple days of the week and/or time periods, thus necessitating additional data.

- Each count location should include notes detailing equipment setup and count location (GPS coordinates and/or SR/Segment/Offset information). The notes from count setup should accompany data worksheets.
- Older tube count data collection methods that use a single tube configuration spanning the subject roadway or lane that only records the number of axles should be avoided. Preferably, automatic counts should classify vehicle types using a multiple-tube setup.
- Automatic count equipment should not be placed in locations affected by parking maneuvers, regular queuing, or where double-counting may occur.
- Generally sensors (including tubes) should be installed at right angles to the flow of traffic.
- The time at which equipment setup and retrieval occurs should be recorded.
- Count stations should be monitored periodically and field equipment should be checked in accordance with a project data collection plan.
- In cases where queuing or other on-street conditions would impact automatic counts, supplemental manual counts along the subject roadway or at nearby intersections should be considered in order to verify the automatic data being collected.

### Classification Counts

Vehicle classification counts may be completed manually or automatically. They typically describe intersection turning movements or roadway volumes relative to a predetermined classification scheme. For purposes of HCM-based planning and operational analysis work, classification data is very helpful in determining the appropriate percentage of heavy vehicles and passenger car equivalency factors. Prior to a classification count, analysts should consider any available data from other sources, including PennDOT's Bureau of Planning and Research.

Classification counts should be based on the [FHWA 13-vehicle class system](#). Other classification systems may be appropriate, but should be discussed with the Department at project scoping.

The number or percentage of heavy vehicles is a commonly-required component of many traffic study projects. Generally, the number or percentage of heavy vehicles should be based on the larger vehicles that require greater headways, which are typically vehicle types 4 through 13 according to the [FHWA 13-vehicle class system](#).

### Intersection Delay Studies

Intersection delay studies can be used to evaluate operating conditions or validate the estimated delay coming from a traffic analysis tool. Typically, intersection delay studies are used to calibrate and/or validate an HCM-based analysis. When completing intersection delay studies in the field, the following items should be considered:

- Clearly define how delay measurements are being accurately recorded.
- Collect a minimum of 60 measurements every 10 to 20 seconds in duration, such that the desired period of time is observed. It is recommended that these measurements be completed at the same time as intersection traffic counts to ensure a more accurate data evaluation.

- Delay measurements should be recorded on a per-movement or lane group basis, such that the field data would be relative to the condition being analyzed. Field measurements should be evaluated and used to help validate the corresponding calculated values of delay.

For additional intersection delay study guidance, please review the [HCM2010 Chapter 31](#) (Supplemental Signalized Intersection Chapter) and Chapter 6.2 of the [ITE Manual of Transportation Engineering Studies, 2<sup>nd</sup> Edition](#) prior to collecting data.

**Exhibit 10-3 Sample Intersection Delay Study**

Exhibit 31-47  
Control Delay Field Study  
Worksheet

INTERSECTION CONTROL DELAY WORKSHEET											
General Information					Site Information						
Analyst					Intersection						
Agency or Company					Area Type		<input type="checkbox"/> CBD		<input type="checkbox"/> Other		
Date Performed					Jurisdiction						
Analysis Time Period					Analysis Year						
Input Initial Parameters											
Number of lanes, N					Total vehicles arriving, $V_{arr}$						
Approach speed, $S_a$ (mi/h)					Stopped-vehicle count, $V_{stc}$						
Survey count interval, $I_c$ (s)					Cycle length, C (s)						
Input Field Data											
Clock Time	Cycle Number	Number of Vehicles in Queue									
		Count Interval									
		1	2	3	4	5	6	7	8	9	10
Computations											
Total vehicles in queue, $\Sigma V_{iq}$ =					veh		Number of cycles surveyed, $N_c$ =				
Time-in-queue per vehicle, $d_{wi} = \left( I_c \frac{\Sigma V_{iq}}{V_{arr}} \right) / 0.9$					s/veh		Fraction of vehicles stopping, $FVS = \frac{V_{stc}}{V_{arr}}$				
No. of vehicles stopping/lane/cycle =					$\frac{V_{stc}}{(N_c \times N)}$		Accel-decel correction delay, $d_{ac} = FVS \times CF$				
Accel-decel correction factor, CF					s/veh		Control delay, $d = d_{wi} + d_{ac}$				

Source: HCM2010

**Queue Length Studies**

Queue length studies can be used to help estimate the length of turn lanes or calibrate and validate results from an HCM-based analysis or results from simulation. Typically, queue length studies are collected in the same manner as intersection delay studies.

For additional queue length study guidance, please review the [HCM2010 Chapter 31](#) (Supplemental Signalized Intersection Chapter) and Chapter 6.2 of the [ITE Manual of Transportation Engineering Studies, 2<sup>nd</sup> Edition](#) prior to collecting data.

**Saturation Flow Rate Studies**

Saturation flow rate studies are typically performed in order to calibrate an HCM-based analysis. The saturation flow rate is a crucial element when evaluating capacity. Additionally, saturation flow rates are closely-related to the derivation of start-up lost time and clearance lost time. Saturation flow rate studies are typically collected using manual count methods (i.e. with a stopwatch, count board, or computer application). When completing saturation flow rate studies, the following items should be considered:

- Saturation flow rate studies may be conducted manually or automatically using a myriad of equipment and/or technology, including field worksheets, stop watches, electronic count boards, video footage, hand-held devices, or computers.
- Generally, these studies focus on each unimpeded movement by counting the number of vehicles crossing the stop bar from a standing queue at the beginning of the protected green indication.
  - a. Cycles or movements that are impeded by turning traffic and/or pedestrians should not be included when deriving base saturation flow rates.
  - b. Each applicable movement should be evaluated.
  - c. Car-following behavior and discharge headways may change between congested and lower volume situations, so off-peak measurements may also be appropriate.
- Record the approach grades and lane width(s) corresponding to the observed movement(s) and note if the intersection is located within an urban setting's central business district.
- The study should denote changes in the corresponding phasing (green, yellow, red). At the end of a permitted left-turn phase, record the number of left-turn sneakers who have already entered the intersection or are completing their maneuver after expiration of the permitted phase.
- At a minimum, per applicable movement, at least 15 standing queues that are at least eight vehicles in length should be measured.
  - a. Once a queue of the minimum length has passed the stop bar and has been recorded, the user should stop recording vehicles crossing the stop bar.
  - b. It is acceptable to record standing queues that also include heavy vehicles or trucks; however, those cycles, their times, and the number of heavy vehicles should also be recorded.
- In addition to recording the number of vehicles leaving the stop bar from a beginning of phase standing queue, these studies may also record the number of vehicles crossing the stop bar during yellow and/or red indications as well as the number of left-turn sneakers that enter the intersection after expiration of the permitted left turn green time. The vehicles leaving the stop bar during the yellow and/or all red times can be used to estimate the extension of effective green value.
- Typically the discharge headways associated with the first four vehicles in the queue would be ignored when calculating saturation flows. The additional time above the discharge headway for these initial vehicles would be added together on a per cycle basis to estimate start-up lost time.
- Convert the field-collected saturation flow rates into the prevailing flow rate using the guidance provided in [HCM2010 Chapter 31](#). Also, it may be appropriate to back-calculate the base saturation flow by using the adjustment factors outlined in HCM2010, Chapter 18 Equation 18-5 and the procedures within [HCM2010 Chapter 31](#). This method would require the number of heavy vehicles included within each measurement (if any), the approach grade, area type, and subject lane width. Using this process, the user must be careful to distinguish between values of field-measured, adjusted, and base saturation flow rates.

Exhibit 10-4 is an example of a field saturation flow rate measurement worksheet as provided by the HCM2010. For additional guidance on the collection of field-measured saturation flow rates and the derivation of base saturation flow rates, please review the [HCM2010 Chapter 31](#) (Supplemental Signals Chapter) and as well as Chapter 6.4 of the [ITE Manual of Transportation Engineering Studies, 2<sup>nd</sup> Edition](#).

**Exhibit 10-4 Sample Saturation Flow Rate Field Worksheet**

**Exhibit 31-51**  
Saturation Flow Rate Field  
Study Worksheet

**FIELD SATURATION FLOW RATE STUDY WORKSHEET**

General Information				Site Information			
Analyst:		Intersection:		Area Type:	<input type="checkbox"/> CBD <input type="checkbox"/> Other		
Agency or Company:		Jurisdiction:		Analysis Year:			
Date Performed:							
Analysis Time Period:							

**Lane Movement Input**

Movements Allowed

 Through  
 Right turn  
 Left turn

**Input Field Measurement**

Veh. in queue	Cycle 1			Cycle 2			Cycle 3			Cycle 4			Cycle 5			Cycle 6			
	Time	HV	T	Time	HV	T	Time	HV	T	Time	HV	T	Time	HV	T	Time	HV	T	
1																			
2																			
3																			
4																			
5																			
6																			
7																			
8																			
9																			
10																			
11																			
12																			
13																			
14																			
15																			
16																			
17																			
18																			
19																			
20																			
End of saturation																			
End of green																			
No. veh. > 20																			
No. veh. on yellow																			

**Glossary and Notes**

HV = Heavy vehicles (vehicles with more than 4 tires on pavement)  
 T = Turning vehicles (L = Left, R = Right)  
 Pedestrians and buses that block vehicles should be noted with the time that they block traffic, for example,  
 P12 = Pedestrians blocked traffic for 12 s  
 B15 = Bus blocked for 15 s

Source: HCM2010

**Gap Acceptance Studies**

Similar to gap studies, gap acceptance studies typically collect the number of gaps presented in the major traffic stream that are presented to a subject conflicting turning movement or yielding minor-street vehicles. When completing gap acceptance studies, the following items should be considered:

- Gap acceptance studies may be counted manually using a combination of equipment, including field worksheets, time-recording device, electronic count board, and/or computer. Typically, these studies should bin results on a per-movement basis in 5-minute intervals during peak periods.
- At the onset of the study, distinguish between field gap or headway values. Headway values record the time (front bumper to front bumper) and gap values record the time (leader's rear bumper to follower's front bumper) between vehicles that are conflicting with the subject movement. This distinction should be based on the data and analysis requirements of the study.
- The reference point should be an imaginary line crossing through the intersection.
  - a. Use this line to denote the start and stops of gaps or headways of the traffic opposing the subject movement.
  - b. Be consistent.

- c. Record gaps from the time at which a gap begins all the way through its end, provided there is a vehicle waiting for the subject movement.
- d. If no vehicle is waiting, do not record a gap value.
- If more than one vehicle accepts a single gap, record the follow-up time (the number of seconds the second, third, etc. vehicle is behind the initial leader).
- Distinguish between the gap acceptance values of a subject movement when the vehicle is a passenger vehicle (i.e., passenger car, motorcycle, pick-up truck, etc.) or a heavy vehicle (i.e., truck, bus, tractor-trailer, etc.). Larger vehicle types would inherently have different gap acceptance requirements.
- At unsignalized intersections, gap acceptance of the minor street through movements and the minor street left-turning movements is more difficult to manually-collect in the field because in these cases, simultaneous gaps in both directions of the major street have to be recorded. The gaps would 'reset' upon the arrival of a new major street vehicle from either direction.

For additional guidance on the collection and analysis of local gap acceptance studies, analyst should use the detailed guidance in Chapter 6.5 of the [ITE Manual of Transportation Engineering Studies, 2<sup>nd</sup> Edition](#).

**Exhibit 10-5 Sample Gap Acceptance Study Field Sheet**

Source: Jacobs Engineering Group, Inc.

After collecting sufficient headway data, the study should reduce the data and summarize results. The material provided in Exhibit 10-6 shows some of the analysis work to begin reducing the gap study data using the 'Ramsey and Routledge' (1973) Method. These results can be used to calibrate the critical headway values in HCM2010-based analysis work of unsignalized intersections and roundabouts as well as some default critical gap and gap distributions used by microsimulation models. Some default values specific to conditions observed in Pennsylvania are provided in [Publication 46, Chapter 10.4](#).

**Exhibit 10-6 Sample Gap Acceptance Analysis Worksheet**

Exhibit 6-6. Analysis of Gap Acceptance Data Using The Ramsey and Routledge (1973) Method						
Assume that the following gap acceptance data set with a 2-second interval was collected:						
Gap/Lag Size (sec)	1	3	5	7	9	TOTAL
# of Accepted Gaps	0	5	15	25	5	50
# of Rejected Gaps	60	45	30	15	0	150
Acceptances + Rejections	60	50	45	40	5	200
Increasing Proportions?	YES	0%	10%	33%	63%	100%

*The Ramsey and Routledge method begins with conversion of the acceptances + rejections data above to a percentage and entrance into column 1 of Table A, below.*

Source: ITE Manual of Transportation Engineering Studies, 2<sup>nd</sup> Edition

**Projected Volume Analysis**

Most traffic analysis projects in the Department’s project delivery process and HOP program involve the development of future traffic volume estimates. These estimates should be developed in accordance with the scope and requirements for the subject study.

Projected volume estimates should include the relevant vehicle types (i.e. passenger vehicles and trucks) and non-automobile modes (i.e., buses, pedestrians, and bicyclists) as required by the study. Along with changes in traffic volumes, studies should evaluate changes in the percentage of heavy vehicles, pedestrians, bicyclists, and the distribution and type(s) of heavy vehicle traffic.

The [PennDOT TIS Guidelines](#) provide detailed guidance with regard to trip forecasting and developing projected volumes for use in Transportation Impact Studies and assessments. To the extent feasible, trip forecasting and the development of projected volumes should consider roadway capacity and delay in the course of assigning new traffic to a roadway system. Alternative routes and potential diversions should also be considered when calculating and assigning unconstrained demand forecasts to a network.

Estimates for future traffic volumes may be based on travel demand models, sketch-planning tools, local and/or regional traffic forecasts, the ITE Trip Generation Manual, local studies, and established growth rates growth factors provided by local planning organizations and/or PennDOT’s Bureau of Planning and Research. Seasonal adjustment factors should be used to account for temporal variations in annual traffic.

**Traffic Signal Warrant Analysis**

The requirements can be found in Publication 46, Chapter 4.3.

**Turn Lane Warrant Analysis**

The requirements can be found in Publication 46, Chapter 11.16.

**Left-Turn Phase Warrant Analysis**

The requirements for a left-turn phase warrant analysis are provided in Publication 46, Chapter 4.6 of this document as well as the Department’s Traffic Signal Design Handbook ([Publication 149](#)).

## 10.3 Traffic Analysis Tool Selection

### Project Understanding and Analysis Context

Most studies, including transportation impact studies, point of access studies, traffic signal timing and design reports, traffic impact assessments, corridor studies, and turn-lane warrant assessments are operationally-focused where specific design or operational conditions are being assessed. Some studies have broader, more order-of-magnitude interests with less available data, or they are focused on longer-range analysis scenarios that may be used in making planning-level assessments.

At project scoping, the analyst should consider the requirements of the study itself, including the necessary input data requirements and the required output (i.e., HCM LOS, HCM delay, travel time, emissions, fuel consumption, and/or others, etc.) and determine if the traffic analysis is in a 1) design or operations context, or 2) planning context. Typically, most projects have a single analysis context and they are 1) operationally-focused. The analysis context should be established before selecting a tool category.

Typically, transportation impact studies completed as part of the Department's Highway Occupancy Permit (HOP) program should not be classified as projects with a planning context. These studies are focused on detailed operational issues, not order-of-magnitude interests.

### Overview

Volume II of the [FHWA Traffic Analysis Toolbox](#) is designed to assist traffic engineers and planners in selecting the most appropriate traffic analysis tool. This toolbox and the HCM2010 group traffic analysis tools into eight categories. Most commercially-available software packages, including those implementing HCM-based methods, fit within one or more of these major categories. The analysis tools and commercial software packages supported by the Department are indicated in Chapter 12.2. Only five of the most common traffic analysis tool categories are addressed within this section; however, this does not preclude a project from considering other traffic analysis tool categories and tool selection. This section provides guidance on first selecting the appropriate tool category before going to the list of supported software packages as listed in Publication Chapter 12.2.

### Sketch-Planning Tools

Sketch-planning tools are typically rather simple, low-effort analysis techniques used to provide a quick analytic response. They are commonly employed in order to develop order-of-magnitude results and usually lack precision. Their relative low effort and ease of use make them appropriate in the context of planning, and they may not be appropriate where detailed input and output parameters are required. The Department supports the use of sketch-planning tools for only planning-level assessments.

### Travel Demand Models

Travel demand forecasting may be an activity of larger transportation studies, including transportation impact studies. Typically, most studies assessing future conditions under various land development scenarios would employ the traditional 4-step trip forecasting procedure. The traditional 4-step trip forecasting process can be defined as a sequential process of trip generation, distribution, mode split, and trip assignment as outlined in the Department's [Transportation Impact Study Guidelines](#). Some projects may use limited, spreadsheet-driven tools that focus on the use of population or employment-based gravity models in order to develop trip assignments for a particular land development project or scenario. The Department supports the use of trip estimates from travel demand models. The source the trip estimates



(as would be the case with third party travel demand modeling work) and/or the use of a travel demand model should be identified during project scoping.

### **HCM-Based or Deterministic Tools**

Analytical or deterministic tools estimate roadway or intersection capacity, density, delay, and other performance measures using a prescribed set of equations and procedures that are not subject to randomness and can be repeatable. Many of these tools, although not all, are based on HCM methodologies. Typically deterministic tools, including those based wholly or in part on the HCM, are best utilized for analyzing isolated facilities or small-scale transportation networks, as the HCM methods have little or no ability to account for the interactions between network elements or facilities, and most commonly, they do not reflect the impact on operations between adjacent facilities. The limitations of the HCM methods should be understood and recognized before selecting a deterministic tool for use with a given traffic study project.

Provided the HCM2010 methods are successfully implemented by a specific commercial or available tool, and the methods are appropriate for the subject traffic analysis project, HCM-based or deterministic tools should be used for the operational analyses conducted as part of the PennDOT Transportation Impact Study and project development processes. If the HCM2010 methods are not appropriate or a limitation is encountered, the analyst should use the HCM2010 [Alternative Tools Analysis](#) procedure.

### **Optimization Tools**

Signal optimization tools are used to help identify optimal signal cycle lengths, phase times, splits and offsets for signal systems ranging from isolated signals to full networks. Some optimization tools are also capable of generating HCM-based measures of effectiveness. Generally, these tools seek to reduce delay and improve operating conditions by developing what would be considered optimized signal control. Typically, signal optimization tools require input parameters that are specific to traffic signal control parameters. The results from signal optimization work should be coupled with engineering judgment when deriving changes to traffic signal timing and phasing. The objective functions and underlying procedures of the selected optimization tool should be understood and recognized.

It is important to distinguish between HCM-based tools and optimization tools, since a project may use HCM-based tools or microsimulation tools to derive performance measures such as delay, LOS, density, and travel time, while optimization tools for the same project may be used to help derive traffic signal timing and/or phasing modifications. The Department accepts the use of a combination of appropriate tools for the analysis, signal optimization, and/or simulation of a given traffic analysis project.

### **Microscopic Simulation Models**

The [FHWA Traffic Analysis Toolbox](#) provides a large amount of additional guidance and information pertaining to the selection and application of microscopic simulation models. The [FHWA Traffic Analysis Toolbox](#) contains several publications that provide detailed guidance in the selection and application of microscopic simulation models. Microscopic simulation models are popular tools within the industry and can assess the individual movement of vehicles over a network while explicitly accounting for many issues that may not be addressed by HCM methods or deterministic tools. They are especially helpful when a traffic analysis project needs to provide animation or visualization of certain geometric or operational conditions, say for example project presentations and outreach efforts. More so, microscopic simulation models are considerably-more powerful in assessing complex geometric, demand, and traffic control,

scenarios for various projects and tend to offer several measures of effectiveness that can be used to demonstrate the benefits and costs of a given project.

It is important to note that while deterministic tools may be the appropriate analysis procedure, microscopic tools are more powerful and in most cases would meet or exceed the same project needs, but likely with an increased effort. Typically, microscopic modeling work requires more time, data, and modeling work in order to produce performance measures as compared with deterministic models. While the Department supports the use of microscopic simulation models, the decision to use them should be measured against the sufficiency of the appropriate deterministic or HCM-based tool. In very few cases should microscopic simulators or sketch planning tools be in 'competition' with regard to a traffic analysis tool selection decision, as microsimulation is not a recommended analysis tool category for planning-level analyses.

In many cases, microscopic simulation models may be the preferred tools, even in cases when deterministic or HCM-based models are appropriate.

### **FHWA Decision Support Methodology (DSM)**

Volume II of the FHWA [Traffic Analysis Toolbox](#) provides detailed guidance and worksheets for traffic analysis category and tool selection. The provided worksheets are automated in a decision support tool available online at [http://ops.fhwa.dot.gov/trafficanalysistools/tat\\_vol2/dsm\\_auto\\_tool.xls](http://ops.fhwa.dot.gov/trafficanalysistools/tat_vol2/dsm_auto_tool.xls).

Using the available spreadsheet as a tool, this method consists of nine primary steps that go through an exhaustive list of seven sets of criteria that may be important to a given traffic analysis project. Note that some of the requested criteria may not be relevant for the given traffic study. This DSM may be used to identify the appropriate traffic analysis tool category during the project scoping process. While other tool category types (such as mesoscopic simulation models) may be used, the three primary analysis tool categories that should be considered when making design decisions, evaluating and identifying traffic signal timing and phasing modifications, or assessing varied operational conditions as part of most traffic analysis projects are:

- 1) HCM-based or deterministic tools;
- 2) Optimization tools; and
- 3) Microsimulation tools.

In some cases, the Department may require or be involved in the commission of a transportation study with a planning focus. In cases where available data is limited and longer-range assessments are required, the two key analysis tool categories are:

- 1) Sketch-planning tools; and
- 2) HCM-based or deterministic tools.

It is important to note that the decision support methodology does NOT recommend specific commercial software products. Selection of a particular commercial software product should be based on the most appropriate traffic analysis tool category for the project and the commercial software currently accepted by the Department. Based on the recommended traffic analysis tool category or categories for the subject traffic study project, the process identified below or in Publication 46, Chapter 12.2 should be used to identify the candidate software package(s) to be used by the traffic study project.

If the desired analytical or simulation software is not found within Publication Chapter 12.2, a written request should be sent to the appropriate Engineering District Office for consideration. Within the request,

the reasons why an alternative analytical or simulation software should be clearly identified along with the added benefits of using the alternative software compared to the Department supported software platforms. The Engineering District Office will evaluate each request and the District Traffic Engineer should provide a written response as to whether the alternative analytical or simulation software could be used on a particular project. Note that an alternative analytical or simulation software analysis should not be submitted to the Department until a written response has been received by the District Traffic Engineer. If an Engineering District Office receives an alternative analytical or simulation software then coordination with the Bureau of Maintenance and Operations, Traffic Operations Section is recommended to ensure that an appropriate way of evaluating the accuracy of the model has been determined.

### **Tool Selection Matrix**

Typically, most traffic analysis projects that are being used to help make detailed design-oriented decisions or assess specific operational conditions and scenarios that have a design or operations context. Some projects may have a planning-oriented focus where less data is available and results may be more appropriate as order of magnitude estimates.

Exhibit 10-7 below provides a checklist of analysis tool categories which are relevant to several common traffic analysis or study projects, which typically have a planning-level focus. It should be noted that some of these traffic analysis or study projects may also have an operations focus. In addition to the guidance previously given in this section, Exhibit 10-7 should be used to help identify the likely tool category types for projects with a planning context.

**Exhibit 10-7 Pennsylvania Traffic Analysis Tool Categories, Planning Context**

Project Analysis and/or Study Type	Relevant Department Publication(s)	Planning Context Tool Category		Notes
		Sketch Planning Tools	HCM-Based Tools	
<ul style="list-style-type: none"> <li>• NEPA Alternatives Analysis *</li> </ul>	PennDOT <a href="#">Publication 10</a> Chapter 7.1	✓	✓	Sketch planning tools as well as planning-level applications of the HCM methods may be appropriate, including the HCM generalized service volume tables and the signalized intersection quick estimation method.
<ul style="list-style-type: none"> <li>• Planning or Long-Range Feasibility Study</li> </ul>	PennDOT <a href="#">Publication 10C</a> Chapter 3.3	✓	✓	Sketch planning tools as well as planning-level applications of the HCM methods may be appropriate, including the HCM generalized service volume tables.
<ul style="list-style-type: none"> <li>• Point of Access Study *</li> </ul>	PennDOT <a href="#">Publication 10X</a> Appendix Q	✓	✓	Sketch planning tools as well as planning-level applications of the HCM methods may be appropriate, including the HCM generalized service volume tables.
<ul style="list-style-type: none"> <li>• Safety Study</li> </ul>	PennDOT Publication 46 Chapter 11.1	✓	NA	Some sketch planning tools may be helpful in quantifying the implications on safety; however, HCM-based tools in the planning context are not appropriate for the safety-related analysis work in some traffic engineering and/or safety studies.
<ul style="list-style-type: none"> <li>• Work Zone Assessment *</li> </ul>	PennDOT Publication 46 Chapter 6.3	✓	NA	In a planning context, some sketch planning tools, including the PennDOT Delay Analysis Workbook (DAWB) procedures may be used to provide order of magnitude performance measures by which to identify and evaluate longer-range work zone impacts.

Legend:

NA = Not Applicable

✓ = This particular analysis or study type would be appropriately supported by the tool category.

\* May also have an operations-focused context, where more detailed design decisions or operational conditions are required.

Exhibit 10-8 provides a checklist of analysis tool categories which are relevant to several common traffic analysis or study projects, which typically have an operational-level focus. Most traffic study projects reviewed or required by the Department would have operational-level contexts such that detailed design decisions, impact assessments, mitigation identification, and other performance measures are required. Typically, HCM-based tools that successfully implement the HCM2010 methods are used to quantify project-specific performance measures. When an HCM methodological limitation is encountered, or supplemental information is required, a microsimulation tool may also be used. It should be noted that some of these traffic analysis or study projects may also be conducted within a higher-level planning level context. In addition to the guidance previously given in this section, Exhibit 10-8 should be used to identify the likely tool category types for projects with an operations context.

**Exhibit 10-8 Pennsylvania Traffic Analysis Tool Categories, Operations Context**

Project Analysis and/or Study Type	Relevant Department Publication(s)	Operations Context Tool Category			Notes
		HCM-Based Tools	Optimization Tools <sup>1</sup>	Micro-simulation Tools	
<ul style="list-style-type: none"> <li>Transportation Impact Study</li> <li>Traffic Impact Assessment</li> </ul>	<a href="#">PennDOT Transportation Impact Study Guidelines (SOL 470-09-04)</a>	✓	✓	✓	HCM-based tools and microsimulation tools, when applicable, may be used to compute significant performance measures such as LOS and delay. Optimization tools may be used to derive modifications to signal operations.
<ul style="list-style-type: none"> <li>Local Roads Study</li> </ul>	PennDOT <a href="#">Publication 70M</a> Chapter 3.3	✓	✓	✓	In the study and design of locally-owned roadways, these three tool categories are also relevant, just as with traffic analysis projects for state-maintained roadways.
<ul style="list-style-type: none"> <li>Work Zone Assessment **</li> </ul>	PennDOT Publication 46 Chapter 6.3	✓	NA	✓	In an operational context, some HCM-based tools and microsimulation tools can be used to assess work zone operations
<ul style="list-style-type: none"> <li>Roundabout Study</li> </ul>	PennDOT <a href="#">Publication 414</a>	✓	NA	✓	Operational conditions at existing and proposed roundabouts can be assessed with HCM-based and simulation tools.
<ul style="list-style-type: none"> <li>Signal Timing / Phasing Study</li> <li>Traffic Control Warrant Study</li> </ul>	PennDOT Publication 46 Chapter 4.3	✓	✓ <sup>2</sup>	✓	Detailed signal design and parameter assessments may be performed using a combination of all three tool category types, with simulation tools typically being used when HCM limitations occur, or supplemental information is required.
<ul style="list-style-type: none"> <li>Turn Lane Warrant / Restriction Study</li> <li>No-Turn On-Red Study</li> <li>Pedestrian Crossing Study</li> </ul>	PennDOT Publication 46 Various	✓	✓ <sup>2</sup>	✓	Typically, these study types involve the exploration of established warrants, supplemented with operational information, including LOS and delay. Typically, optimization tools are not necessary to evaluate these

Legend:

NA = Not Applicable

✓ = This particular analysis or study type would be appropriately supported by the tool category.

\*\* May also have a planning focused context, where longer-range scenarios with less available data can be explored.

<sup>1</sup> Optimization tools would be used to accompany operational analyses performed by deterministic or microsimulation tools.

<sup>2</sup> Some studies may require operational analysis components with optimized signal timing.

---

## 10.4 Highway Capacity Manual (HCM) Analysis

### Role

The Department accepts the use of the HCM2010 methods in order to meet the planning, operational, and design-level analysis needs of most traffic study projects. These methods should be the primary way of determining off-line performance measures as needed for a variety of traffic study projects reviewed and/or commissioned by the Department. The role of this section is to provide additional guidance on the specific methodological components for the core facility types addressed by the HCM2010. This section also includes recommended Pennsylvania default values for some calibration parameters as well as guidance as to when an alternative analysis tool should be used.

### Online Material

With the HCM2010, an entire volume is located online at [www.hcm2010.org](http://www.hcm2010.org). As interpretations and errata are addressed by the HCQS Committee, changes to the HCM2010 can be expected and would be posted on this site. Practitioners should be aware of the latest guidance and materials provided on this site. The Department may require time to respond to any changes made to the material posted on [www.hcm2010.org](http://www.hcm2010.org), in order to update policies after the release of any additional or revised material having an impact on the guidance provided herein.

### Pennsylvania Default Values

A limited number of studies throughout Pennsylvania have been conducted that provide initial estimates for some default values, which are organized by land use context only. These initial studies were conducted at select locations throughout the Commonwealth between April and May of 2012 under a myriad of geometric and operational conditions. These defaults are representative of conditions surveyed in Pennsylvania, but they may not be appropriate for all projects. Project-specific data measured locally in the field may be collected in order to justify changes to the default values noted herein or those recommended by the HCM2010. In the absence of locally-derived values, the Pennsylvania default values are recommended and should be used.

For those parameters without Pennsylvania default values or locally-collected data, the HCM2010 default values should be used. If the Pennsylvania default values provided herein or the HCM2010 default values are not appropriate for a given project, the collection and use of locally-collected data should be discussed at project scoping.

### Land Use Context

In application of the Pennsylvania-specific default values herein, the traffic analysis project should identify the location of the given project area or facility in terms of its land use context; urban, suburban, or rural. The definitions for these land use contexts are provided in the Department's [March 2008 Smart Transportation Guidebook](#).

- 1) The rural land use context should be used for low density areas that have very little to no development along the major roadway system, or those uses which may be considered as rural hamlets.
- 2) The suburban land use context should be used for suburban neighborhood, corridor, and center land use conditions that feature a wide range of low to medium density development conditions, with some propensity towards mixed-use development.

- 3) The urban core land use context should be used for urban cores and major city centers that have the highest density development and a high amount of non-automobile traffic (i.e. pedestrian, bicycle, transit traffic).

Similarly, in application of the HCM2010 recommended default values, when necessary, the traffic analysis project should identify whether or not the given project area or facility is located within a metropolitan area with a population equal to or greater than 250,000 inhabitants. The definition for metropolitan areas should be based on the most recent guidance regarding metropolitan statistical areas (MSA) as defined by the [United States Census Bureau](#). Since the HCM2010 provides default values for only two possible land use context scenarios, it is important for the analyst to first determine whether or not a project is located in a MSA based on this guidance. These definitions should be used to identify the appropriate default values.

**Base Saturation Flow Rates**

Traffic analysis projects should use the Pennsylvania default values for base saturation flow rates as provided in Exhibit 10-9 below, unless local data is available, for the analysis of isolated and coordinated signalized intersections as well as urban street facilities, according to the corresponding land use context. The default base saturation flow rates in Exhibit 10-9 are not appropriate for use by other procedures or for the analysis of other facility types. Typically, a single base saturation flow rate should be used for all movements of a signalized intersection.

**Exhibit 10-9 Pennsylvania Base Saturation Flow Rates (Signalized Intersections)**

Base Saturation Flow Rates	HCM2010 Defaults (pcphpl)		Pennsylvania Defaults (pcphpl)		
	Metropolitan Areas	Other	Urban Core	Suburban	Rural
Signalized Intersections and Urban Streets	1900	1750	2100	1800	1650

**Start-Up Lost Time, Extension of Effective Green Time, and Sneakers**

Traffic analysis projects should use the Pennsylvania default values for start-up lost time, extension of effective green time, and number of left-turn sneakers as provided in Exhibit 10-10, unless local data is available, for the analysis of isolated and coordinated signalized intersections as well as urban street facilities, according to the corresponding land use context as well as total clearance time (yellow plus all-red time) for subject signal phase. Typically, start-up lost time and extension of effective green time should be applied on a movement basis for each signal phase at the subject signalized intersection. Typically, a single intersection-wide value should be provided for the number of left-turn sneakers.

**Exhibit 10-10 Pennsylvania Traffic Signal Control Calibration Parameters (Signalized Intersections)**

Traffic Signal Control Parameters	HCM2010 Defaults	Pennsylvania Defaults (seconds, or number of vehicles)		
	All Areas	Urban Core	Suburban	Rural
Start-Up Lost Time	2.0 seconds	2.5 seconds	2.5 seconds	3.0 seconds
Extension of Effective Green Time	2.0 seconds	3.0 seconds when Y+AR < 6.0 seconds, otherwise 4.0 seconds	3.0 seconds when Y+AR < 5.0 seconds, otherwise 3.5 seconds	2.0 seconds when Y+AR < 4.5 seconds otherwise 2.5 seconds
Number of Left Turn Sneakers	2 vehicles	2 vehicles	2 vehicles	2 vehicles

Y = Yellow change interval

AR = All-red clearance interval

**Base Critical Headway at Two-Way Stop-Controlled (TWSC) Intersections**

Traffic analysis projects should use the Pennsylvania default values for base critical headways as provided in Exhibit 10-11, unless local data is available, for the analysis of unsignalized two-way stop-controlled intersections, according to the corresponding land use context and critical movements shown below. The values provided in Exhibit 10-11 are for single or one-stage maneuvers only along two-lane and four-lane roadways. The default critical headway values for two-stage maneuvers and six-lane roadways as presented in [HCM2010 Chapter 19](#) should be used for those facility types, unless additional local data is available. Base critical headways should be applied for each critical movement at the subject intersection.



**Exhibit 10-11 Base Critical Headways at TWSC Intersections**

Base Critical Headways at TWSC Intersections (by critical movement)	HCM2010 Defaults (seconds)		Pennsylvania Defaults (seconds) for 1-Stage Maneuvers					
	All Areas		Urban Core		Suburban		Rural	
	Two Lanes	Four Lanes	Two Lanes	Four Lanes	Two Lanes	Four Lanes	Two Lanes	Four Lanes
Left Turn from Major Roadway	4.1	4.1	4.1	3.7	4.3	3.9	4.9	5.2
U-Turn from Major Roadway**	N/A	6.4 (wide) 9.9 (narrow)	N/A	6.4 (wide) 9.9 (narrow)	N/A	6.4 (wide) 9.9 (narrow)	N/A	6.4 (wide) 9.9 (narrow)
Right Turn from Minor Roadway	6.2	6.9	6.2	6.1	6.2	7.2	6.4	6.1
Through Traffic on Minor (1 stage only)	6.5	6.5	6.5	6.5	6.5	6.5	6.5	6.5
Left Turn from Minor (1 Stage only)	7.1	7.5	7.1	6.7	7.1	8.4	8.1	8.3

\*\*Consult with District Traffic Engineer before using wide or narrow values

**Base Follow-Up Headway at Two-Way Stop Controlled (TWSC) Intersections**

Traffic analysis projects should use the Pennsylvania default values for base follow-up times for one-stage and two-stage maneuvers as provided in Exhibit 10-12, unless local data is available, for the analysis of unsignalized two-way stop-controlled intersections, according to the corresponding land use context and critical movements shown below. The default critical headway values for six-lane roadways as presented in [HCM2010 Chapter 19](#) should be used for those facility types, unless additional local data is available. Base follow-up headways should be applied for each critical movement at the subject intersection.

**Exhibit 10-12 Base Follow-Up Headways at TWSC Intersections**

Base Follow Up Headways at TWSC Intersections (by critical movement)	HCM2010 Defaults (seconds)		Pennsylvania Defaults (seconds) for 1-Stage and 2-Stage Maneuvers					
	All Areas		Urban Core		Suburban		Rural	
	Two Lanes	Four Lanes	Two Lanes	Four Lanes	Two Lanes	Four Lanes	Two Lanes	Four Lanes
Left Turn from Major Roadway	2.2	2.2	2.2	2.8	3.0	2.4	3.5	3.4
U-Turn from Major Roadway**	N/A	2.5 (wide) 3.1 (narrow)	N/A	2.5 (wide) 3.1 (narrow)	N/A	2.5 (wide) 3.1 (narrow)	N/A	2.5 (wide) 3.1 (narrow)
Right Turn from Minor Roadway	3.3	3.3	3.3	3.2	3.1	2.9	3.4	3.1
Through Traffic on Minor	4.0	4.0	4.0	4.0	4.0	4.0	4.0	4.0
Left Turn from Minor	3.5	3.5	3.5	2.5	3.0	2.8	3.0	3.4

\*\*Consult with District Traffic Engineer before using wide or narrow values

**Multi-Period Analysis**

For the operational analysis of signalized intersections, urban streets, and freeway facilities, traffic analysis projects should use the **multi-period analysis**, sometimes referred to as Approach C in the HCM2010. The multi-period analysis procedure accounts for the carryover of unmet demand from one time period to the next during periods of oversaturation. For a multi-period analysis, the peak hour factors for all movements should be equal to 1.0 and at least four consecutive 15-minute intervals through the identified peak period should be analyzed and compiled, using an analysis period duration (T) of 0.25 hours, or 15 minutes. If the necessary data is unavailable and the facility and its comprising movements are under capacity, the traditional Approach A method may be used, such that the intersection peak hour factor may be less than 1.0 and the analysis period duration (T) is equal to 0.25 hours, or 15 minutes. Approach A may not be appropriate for all projects, as it neglects queue carryover from one period and may not adequately include the initial queue delay (d<sub>3</sub>) component of the control delay equation (for signalized intersections and urban street facilities).

When utilizing the multi-period analysis, the guidance provided by the HCM2010 should be followed. The analyst should include at least four (4) consecutive 15-minute intervals such that the duration of the period of oversaturation is addressed. For projects that need the results for a single analysis period from which to derive results and/or conclusions, the analyst may use just the 15-minute interval reflecting the highest valued of aggregated intersection control delay; otherwise, the results from each 15-minute interval throughout the analysis period should be used.

### Demand versus Service

Generally, the HCM2010 operational methods require the actual or projected demand volumes for each movement or lane group; not necessarily the volumes that cross the stop bar, or those that are successfully serviced by or departing a given facility. For example, traditional turning movement counts tend to record only the number of vehicles departing from the intersection and not necessarily the actual demand, which may be higher. When demand nears and/or exceeds capacity, field counts as well as projected volumes should reflect actual demand. When measured in the field, demand should be based on a traffic count taken upstream of the maximum extent of the observed queue. Under some conditions, it may be difficult to estimate the required values for demand. In those cases, projects should collect additional calibration data, including but not necessarily limited to delay measurements, travel time runs, queue lengths, gap acceptance studies, and/or saturation flow rate measurements, in order to estimate the actual demand.

Refer to the [HCM2010](#) for additional guidance regarding the collection and incorporation of demand data as part of HCM-based analysis work.

### Peak Hour Factors

Peak hour factors are a measure that describes traffic demand fluctuation within the analysis hour. They illustrate the proportion of peak hour traffic that occurs within a particular period of time within the analysis hour. Traditionally, they are used by HCM-based tools to adjust field counts or projected volumes in order to consider the highest flow rate within the peak hour period, typically the flow rate of the peak 15-minute interval. Therefore, peak hour factors serve in a way as an upward adjustment to the analysis volume already provided by the analyst. The process of dividing the peak hour factor into the hourly analysis volume produces a demand flow rate, which is then carried through an HCM-based analysis and ultimately used to derive results.

There are numerous ways in which peak hour factors can be calculated. Based on national research and guidance provided in the HCM2010, a single, uniform peak hour factor for use in the capacity analysis of intersections and roadways should be used. For intersections, the calculation and use of peak hour factors by lane group, lane, movement, or approach has been found to produce higher analysis volumes, potentially overstating impacts.

For signalized intersections, urban streets, and to some degree freeway facilities, peak hour factors are relevant only when an analysis does not use the recommended multi-period analysis (Approach C).

### Signalized Intersections

The Department accepts the use of the [HCM2010 Chapter 18](#) methods for estimating the performance of a signalized intersection from the perspective of the automobile, pedestrian, and bicycle modes. These procedures should be used for 3-leg and 4-leg intersections that operate in isolation from nearby signals in a pre-timed, semi-actuated, or fully-actuated mode. Signalized intersections that are not isolated, operate in an actuated-coordinated manner, or are part of a system or corridor should be analyzed with a combination of both the signalized intersection methods outlined in [HCM2010 Chapter 18](#) and the urban street procedures outlined in [HCM2010 Chapter 17](#).

In the absence of local data, traffic analysis projects that involve signalized intersections should also use the Pennsylvania Default Values provided in Exhibit 10-9 and Exhibit 10-10.

Traffic analysis projects should recognize and account for the methodological limitations of the signalized intersection methods. For signalized intersections that do not fit within the analytical framework of the

HCM2010, including but not limited to signalized intersections with 5 or more legs (approaches), those with more than 2 exclusive turn lanes on any approach, or those with complex geometry or controller operations, among other limitations, the analyst should use an alternative analysis tool in accordance with the HCM2010 Alternative Tool Analysis procedure.

### **Two-Way Stop-Controlled (TWSC) Intersections**

The Department accepts the use of the [HCM2010 Chapter 19](#) methods for analyzing the performance of a two-way stop-controlled intersection from the perspective of the automobile mode and the pedestrian mode. These methods are intended for 3-leg and 4-leg intersections with stop-control only on the side street(s) such that the conflicting flow calculations in Step 3 of [HCM2010 Chapter 19](#) are appropriate and other limitations do not preclude their use.

In the absence of local data, traffic analysis projects that involve TWSC intersections should also use the Pennsylvania Default Values provided in Exhibit 10-11 and Exhibit 10-12.

Traffic analysis projects should recognize and account for the methodological limitations of the TWSC methods. For TWSC intersections that do not fit within the analytical framework of the HCM2010, including but not limited to TWSC intersections where the conflicting flow equations do not fit the subject intersection, queue interactions from adjacent intersections, or pedestrian impedance to major street vehicular traffic, among other limitations, the analyst should use an alternative analysis tool in accordance with the HCM2010 Alternative Tool Analysis procedure.

### **All-Way Stop-Controlled (AWSC) Intersections**

The Department accepts the use of the [HCM2010 Chapter 20](#) methods for analyzing the performance of unsignalized intersections with stop-control on all approaches. These procedures are intended for typical configurations of independent three-leg and four-leg intersections that require every vehicle to stop, such that there are no more than three lanes on any given approach. Traffic analysis projects should recognize and account for the methodological limitations of the AWSC methods. For AWSC intersections that do not fit within the analytical framework of the HCM2010, including but not limited to AWSC intersections with queue interactions from adjacent intersections or the impact of pedestrians, among other limitations, the analyst should use an alternative analysis tool in accordance with the HCM2010 Alternative Tool Analysis procedure.

### **Mid-Block Pedestrian Crossings**

The Department accepts the use of the methods outlined by the [HCM2010, Chapter 19](#) Pages 19-30 through 19-36 for one-stage and two-stage unsignalized mid-block pedestrian crossings, with or without a median refuge area, which are not located at an intersection. Mid-block pedestrian crossings can be assessed and prescribed a LOS by calculating seconds of delay per pedestrian or pedestrian-group, dependent on how the data was collected in the field. Typically, pedestrians and not pedestrian-groups would be counted in the field. The analysis of a two-stage, mid-block pedestrian crossing assumes the availability of an adequately-sized and safe median refuge area.

In some cases, motorists may yield to pedestrians at these locations. Various enhanced treatments have been found to encourage differing motorist response rates. In the absence of local data, and subject to engineering judgment, traffic analysis projects should use the recommended default motorist yield rates in the [HCM2010 Chapter 19](#) Exhibit 19-17. For additional guidance on unsignalized mid-block crossings and crosswalks, refer to Publication 46, Chapter 11.9.

Traffic analysis projects should recognize and account for the methodological limitations of the Mid-Block Pedestrian Crossing methods (i.e. the TWSC pedestrian mode methods). For mid-block pedestrian crossings that do not fit within the analytical framework of the HCM2010, including but not limited to signalized mid-block crossings or cases where the impact on the major street vehicular traffic is relevant, the analyst should use an alternative analysis tool in accordance with the HCM2010 Alternative Tool Analysis procedure.

## Roundabouts

The Department accepts the use of the [HCM2010 Chapter 21](#) methods for the analysis of isolated roundabouts with one-lane and two-lane entries, up to one yielding or non-yielding bypass lane per approach, and up to two circulating lanes, subject to the following modification; The assumed value of zero seconds of control delay for free-right turning traffic on any given approach to a roundabout, as controlled by a non-yielding bypass or similar free-flow lane, may need to be removed from the subsequent approach and overall delay and LOS calculations. This determination should be made by the Department, especially when comparing results between different facility types at the same location.

For the analysis of existing roundabouts, the Department supports, but does not require, collection of project-specific critical headway and follow-up data, and when local data is not available, traffic analysis projects should use the HCM2010 recommended default values. Locally-measured critical headway and follow-up times can be used to calibrate the capacity equations to better match expected conditions.

Traffic analysis projects should recognize and account for the methodological limitations of the HCM2010 roundabout methods. For roundabouts that do not fit within the analytical framework of the HCM2010, including but not limited to cases involving interactions between adjacent signals or other roundabouts, the provision of more than two entry lanes on an approach (other than bypass lanes), or a high number of pedestrian and/or bicycle conflicts, the analyst should use an alternative analysis tool in accordance with the HCM2010 Alternative Tool Analysis procedure.

## Urban Streets

The Department accepts the use of the [HCM2010 Chapters 16 and 17](#) for a comprehensive bi-directional analysis of an entire urban street facility, including the intersections and segments that comprise it. These methods may be used for one-way and two-way arterial and collector roadways of varying posted speed limits. Signalized intersections that operate in an actuated-coordinated manner, or are part of a system or corridor should be analyzed with a combination of both the signalized intersection methods outlined in [HCM2010 Chapter 18](#) and the urban street procedures outlined in [HCM2010 Chapter 17](#).

These methods provide the analytical framework to assess the automobile, pedestrian, bicycle, and transit modes by assigning levels of service (LOS) and calculating other performance measures by mode for each direction of travel along each segment of the given urban street facility, in addition to mid-block access points and other study intersections. The methods for TWSC, AWSC, and signalized intersections should also be considered part of the urban street methods; to the extent that those facilities exist along the subject roadway. This integration allows for a 'Complete Streets' approach in terms of analysis.

At a minimum, corridors of coordinated signalized intersections should be analyzed using the urban street methods such that the [HCM2010 Chapter 17](#) average phase duration procedure and other analytical components related to progression and vehicular platooning are successfully addressed. The reporting of segment and facility-level performance measures is optional.

At project scoping, stakeholders should determine the need for an overall facility analysis, and in those cases, the segment and facility-level performance measures should be analyzed.

Traffic analysis projects should recognize and account for the methodological limitations of the HCM2010 urban street methods. Consequently, limitations of the individual intersection methods should also be considered limitations of the urban street methods. For urban street facilities that do not fit within the analytical framework of the HCM2010, including but not limited to cases involving interactions between adjacent intersections, turn-lane spillover, impacts due to mid-block parking maneuvers, or capacity constraints between intersections, the analyst should use an alternative analysis tool in accordance with the HCM2010 Alternative Tool Analysis procedure.

### **Freeway Facilities**

The Department accepts the use of the [HCM2010 Chapter 10](#) methods for the analysis of a combined freeway facility, including the component off-ramp and on-ramp segments, freeway sections, and weaving sections. These methods should be used to assess uninterrupted flow facilities that are generally restricted access, higher-speed roadways through rural, suburban, and urban areas. That facility may be comprised of any combination of merge and diverge points (on and off ramp sections), weaving segments, and basic freeway segments. The methods prescribed by the [HCM2010 Chapter 10](#) and the supporting chapters should be used by traffic analysis projects assessing the performance of freeways and limited access highways.

In cases where off-ramp or surface street conditions impact the performance of the freeway, the freeway facilities methods do not work. In those cases, alternative analysis tools should be used (i.e. simulation).

## 10.5 Multimodal Analysis

### Overview

The multimodal analysis of intersections and roadways is integrated throughout the HCM2010, with several of the previously-mentioned facility types, including urban streets and signalized intersections, having separate procedures to derive LOS and other performance measures for the pedestrian, bicycle, and transit modes, as applicable. The scope of the project's multimodal analysis should be determined at project scoping and prior to the onset of the analysis work. The multimodal analysis of a given facility or project area is an optional analysis component for traffic analysis projects that require assessment of non-automobile mode facilities. This section highlights some of the non-automobile procedures.

### Smart Transportation Context

The multimodal procedures for intersections and urban streets can provide the framework for assessing the balance between the mobility needs of automobile and non-automobile modes. The execution of a multimodal analysis would connect many of the qualitative goals stated in the [March 2008 Smart Transportation Guidebook](#) with the typical traffic study process.

### Pedestrian Mode

The HCM2010 methods for individual signalized intersections provide a procedure to analyze each crosswalk at a signalized intersection and assign a LOS based on a final crosswalk score. At the basic level, each crosswalk would have a score and LOS. Other measures are also calculated by the methods, including corner and crosswalk circulation areas, a pedestrian delay value for each crosswalk, qualitative descriptions of performance for corners and crosswalks, and a statement on pedestrian compliance.

The HCM2010 methods for two-way stop-controlled intersections also include procedures for determining the level of service for each pedestrian crossing or crosswalk that crosses a vehicular traffic stream not controlled by a stop sign. In other words, the pedestrian method applies only to lower rank movements that are not assumed to functionally operate with a zero-value of delay. These procedures apply to one-stage and two-stage pedestrian crossings at TWSC intersections as well as for unsignalized pedestrian crossings, possibly benefiting from some enhanced pedestrian treatments, such as flashing beacons.

### Pedestrian Walking Speed

Traffic analysis projects should use a default value of 3.5 feet per second when using the pedestrian mode procedures for urban streets, signalized intersections, TWSC intersections, and mid-block pedestrian crossings, however other speeds are allowed if a pedestrian study indicates otherwise. Refer to Publication 46, Chapter 4 - Traffic Signals for more information.

### Bicycle Mode

The HCM2010 methods for signalized intersections for the bicycle mode produce a LOS for each approach providing a dedicated bicycle lane, a paved shoulder, available parking lane, or a combination thereof. The bicycle mode methods are much simpler in terms of scope and complexity as compared with the pedestrian mode calculations. However, this method does require additional input that would be new to most traffic study projects. The output is straightforward and consists basically of a score and LOS for each applicable approach.

The HCM2010 methods for urban streets include the performance of an urban street segment from the perspective of a bicyclist by direction (similar to the automobile mode), assuming that a continuous bicycle lane or shoulder is provided. If no bicycle facility is provided, the methods do not apply and bicycle volumes may need to be included within the respective vehicular volumes. This procedure considers the bicycle speeds along the roadway, delay and impedance due to intersections and access points, and ultimately derives a LOS by direction for each segment along the urban street and for the overall facility.

The procedures evaluate the performance of the urban street from the perspective of the bicycle mode. The performance of each link (between intersections) and the performance at the intersections are then combined to derive the performance of the segment, and then segment results are aggregated to determine facility LOS.

### Transit Mode

The [HCM2010, Chapter 16 and 17](#) methods can assess the performance of an urban street by segment, by direction, from the perspective of a transit user. It is not the performance of the transit facility itself. The results for each segment should then be combined by weighted average to derive overall facility performance by direction. The transit mode procedures in [HCM2010 Chapter 17](#) are limited to public transit vehicles operating in mixed or exclusive traffic lanes while stopping along the street in order to pick up and drop off passengers. If no transit routes or stops are located along the urban street, the methods would not apply. These methods would apply for on-street bus routes and some light-rail or trolley lines. This procedure considers the transit vehicle running time along the corridor, the transit vehicle delay due to stops and serving passengers, delay due to transit vehicle re-entering the roadway, passenger waiting time and perceptions on quality of service, transit headways, and station or stop dwell times.

While default values are provided, local data is preferred. If multiple routes are provided, the inputs provided by direction should be representative of average operating conditions for transit.



## 10.6 Alternative Tool Analysis

### Guidance

The HCM2010 includes guidance and procedures for the use of alternative analysis tools (such as simulation software) in order to develop performance measures for facilities or conditions that do not fit within the framework of the interrupted and uninterrupted flow facility chapters. These procedures culminate in the use of vehicle trajectory information produced by a supported micro-simulation product. Those trajectories can be assessed in order to calculate HCM2010 performance measures, including delay, density, and other foundation measures of effectiveness in a manner that is consistent with the HCM2010.

### Highway Capacity Manual Limitations

Even with many of the enhancements and additions to the HCM2010 methodologies, many limitations remain. Many of the same limitations continue to exist in the HCM2010 just as they did in the previous 2000 Edition, including but not limited to issues at signalized intersections such as turn pocket overflow, queue spillback, demand starvation, and interactions between facilities. The HCM2010 documents many limitations and highlights situations when alternative analysis tools should be considered.

### Application

The Department supports the emerging practice of using the HCM2010 alternative tool procedures. The selection of this method most likely involves the use of a microsimulation tool. Use of the alternative tool method as well as the desired simulation software should be identified at project scoping.

## 10.7 Verification, Calibration, and Validation

### Verification

Verification is commonly described as the process by a software developer and other researchers have checked the accuracy of the model in terms of its underlying logic and algorithms.

For purposes of traffic analysis tool selection and application on Department projects, the methods prescribed by the HCM2010 are considered verified, but that does not by itself relegate those methods towards use on a particular project, nor does the acceptance of the HCM2010 methods by the Department infer the use of any particular traffic analysis software.

Refer to Publication 46, Chapter 12.2 for specific commercial software products that are supported by the Department.

### Calibration

#### General

Calibration can be defined as a process by which an analyst modifies default model parameters in order to best estimate field-measured or expected traffic conditions. In a way, calibration is another step in the data input process, whether using deterministic or simulation tools, such that default values offered by the traffic analysis tool are adjusted by the analyst based on local conditions or policy.

Traffic analysis work should be calibrated and documented to clearly indicate the manner in which the necessary input parameters have been provided and the adjustment of default values to match field-measured or otherwise expected conditions. For both deterministic and simulation tools, the Department supports changes to default and input parameters in order to best replicate observed or expected conditions. Refer to Volume III of the Federal Highway Administration's [Traffic Analysis Toolbox](#), and the Institute of Transportation Engineer's [Manual of Transportation Engineering Studies, 2<sup>nd</sup> Edition](#) for additional guidance on calibration. Refer to Publication 46, Chapter 4 for traffic signal information.

#### Calibrating a Simulation Model

Calibration is the process of adjusting input data and model parameters in order to ensure that the simulation results from the models match observed traffic performance in the field. Calibration is an important step in a signal timing project because the development of optimal timing plans depends on how closely the model represents the existing conditions. Calibration should be based on the knowledge of the existing conditions in the network and correct interpretation of the model outputs.

Calibration really serves two purposes:

- It is a "final" check on the quality of the general input data, and
- It involves the "fine-tuning" of the traffic parameters to ensure that the modeling is realistic.

The following general steps should be taken, at a minimum, once all base data have been coded in the model and initial runs have been made to clear up obvious coding problems:

- Before continuing any further, double check the base input data.
- Compare the following measures of effectiveness (MOE's) to ensure that the values are consistent with the way you know the system operates:

- Degrees of saturation
  - Delay and average travel times; and
  - Maximum queue length, or maximum back of queue, depending on the model.
  - For traffic signal projects please review Chapter 4
- If you are not certain of the actual system operation, or if any of the above MOEs do not “measure up” as expected, conduct field studies to verify field conditions.
  - For the more sophisticated models, conduct field studies for the significant advanced modeling features.
  - Vary the appropriate model parameters to bring the simulated or estimated results into better agreement with the field data.
  - Always, continually look for overlooked data errors.

This process demands a thorough understanding of the results and outputs of the various models. Recall that the same MOE may be calculated differently by several programs, and may not even include the same basis of measure.

### **Validation**

Validation can be described as an additional effort on part of the analyst to check the predicted results of the model against field measurements. A process of validating model results tends to be a follow-up activity after successful data input and calibration. Initial modeling work should be validated with supporting field-measured and/or observed conditions.

Calibration and validation should be completed for all traffic analysis projects. The exact scope of this process should be project-specific and can range from the acceptance of default values and the use of field observations to validate performance measures to more detailed efforts that involve local calibration data collection and validating performance using data measured in the field.

Efforts to calibrate and validate traffic analysis work should be discussed and agreed upon by project stakeholders prior to commencing work. Refer to Volume III of the [FHWA Traffic Analysis Toolbox](#) for more guidance.

## 10.8 Traffic Analysis Checklist

### Overview

With the guidance provided within this Chapter, there are a number of procedural steps that should be considered in the conduct of a traffic analysis project, many of which are practically-speaking already implemented in practice. Stakeholders should address these items during project scoping. The material presented by this Chapter is supplemental guidance that does not replace other project scoping requirements for traffic analysis work.

Below is an example step-by-step process of how to perform a traffic analysis. This step-by-step process is intended to be used in parallel with the traditional project scoping process and does not replace the scoping requirements for the various traffic analysis project types under the purview of the Department. This process is not exhaustive, but it does represent many of the major procedural considerations.

### Process

1. Attend a project scoping meeting and obtain consensus between stakeholders;
2. Establish a project data collection plan that identifies the necessary data and supplemental field studies that may be necessary for the subject traffic analysis project using the guidance provided in [Publication 46, Chapter 10.2](#);
3. Identify the manner in which future demand volumes for automobile and non-automobile modes will be calculated;
4. Establish analysis context(s) (planning or operations, or both) as well as the Pennsylvania land use contexts (urban, suburban, or rural) for the traffic analysis project using the guidance provided in [Publication 46, Chapter 10.3](#);
5. Select the appropriate traffic analysis tool category or categories using the selection process in [Publication 46, Chapter 10.3](#) and the desired commercial software packages relative to the required tool categories for the project;
6. If HCM-based tools are appropriate, identify the scope of the operational analysis, including the use of the multimodal analysis and/or the use of the urban street facility analysis options in accordance with Publication 46, [Chapter 10.4](#) and [Chapter 10.5](#);
7. If any methodological limitations would preclude the use of HCM-based tools, identify the specific software tool that may be used in accordance with the [HCM2010 Alternative Tools Method](#) outlined in [Publication, Chapter 10.6](#);
8. Consider the use of locally-collected data for the traffic analysis project, use of the Pennsylvania default values, and the availability of HCM2010 default values using [Publication 46, Chapter 10.4](#)
9. Identify the candidate traffic analysis tool or commercial software using Publication 46, Chapter 12.2;
10. If the desired traffic analysis tool or commercial software is not provided in Publication 46, Chapter 12.2, follow the established procedure requesting the use of another analysis tool; and
11. Establish a calibration and validation data collection plan using the guidance in [Publication 46, Chapter 10.7](#) , in conjunction with the project data collection plan and evaluation of the available default values.

# 11. TRAFFIC STUDIES

## 11.1 General

### Engineering Study and Engineering Judgment

Always base the decision to use a particular device at a specific location on engineering study and the application of engineering judgment. Thus, while this manual provides guidance on performing some traffic studies, it is not a substitute for engineering judgment.

Exercise engineering judgment in the selection and application of traffic control devices, as well as in the location and design of the roads and streets that the devices complement. Therefore, a traffic engineer should make the final decision concerning the application of traffic restrictions.

**Exhibit 11-1** is a table that lists all of the studies that are covered within this chapter. In addition, it lists the page that the information can be found on and appropriate links to forms and instructions.

**Exhibit 11-1 Chapter Studies and Cross References**

Study	See Page	Link to Additional Forms and Information
Approvals	10	<ul style="list-style-type: none"> <li>• <a href="#">The Pennsylvania Vehicle Code. (75 Pa. C.S.)</a></li> <li>• <a href="#">Official Traffic Control Devices. (67 Pa. Code Chapter 212)</a></li> <li>• <a href="#">Municipal Traffic Engineering Certification, (67 Pa. Code Chapter 205)</a></li> <li>• <a href="#">Traffic Signal Design Handbook, Permits (Publication 149)</a></li> <li>• <a href="#">Pavement Marking Handbook</a></li> </ul>
Speed Restrictions	11	<ul style="list-style-type: none"> <li>• <a href="#">The Pennsylvania Vehicle Code. (75 Pa. C.S.)</a></li> <li>• Mechanical, Electrical and Electronic Speed-Timing Devices (<a href="#">67 Pa. Code Chapter 105</a>).</li> </ul>
No-Passing Zones	16	<ul style="list-style-type: none"> <li>• Section 3B.02 of the <a href="#">MUTCD</a></li> <li>• <a href="#">§212.202</a> of Publication 212</li> </ul>
One-Lane and Narrow Bridges and Underpasses	17	<ul style="list-style-type: none"> <li>• See Section <a href="#">11.5</a></li> </ul>
Angle Parking	18	<ul style="list-style-type: none"> <li>• <a href="#">§212.114(b)</a> of Publication 212</li> </ul>
Weight and Size Restrictions	20	<ul style="list-style-type: none"> <li>• <a href="#">67 Pa. Code Chapter 193</a></li> <li>• Engineering and Traffic Study Form TE-109 (<a href="#">Restrictions as to Weight and Size Based on Condition of Highway or Bridge</a>)</li> <li>• Hauling in Excess of Posted Weight Limit (<a href="#">67 Pa. Code Chapter 189</a>)</li> <li>• <a href="#">Official Traffic Control Devices. (67 Pa. Code Chapter 212)</a></li> <li>• Maintenance Manual, <a href="#">Chapter 15, (Publication 23)</a>.</li> <li>• Special Hauling Permit Manual, (<a href="#">Publication 31</a>).</li> <li>• <a href="#">The Pennsylvania Vehicle Code. (75 Pa. C.S.)</a></li> </ul>

Study	See Page	Link to Additional Forms and Information
Engine Brake Retarder Prohibition Policy	24	<ul style="list-style-type: none"> <li>• <a href="#">§4103</a> of the Vehicle Code</li> </ul>
Unsignalized Midblock Crosswalks	25	<ul style="list-style-type: none"> <li>• <a href="#">§212.5(b)(1)(v)(T) of Publication 212</a></li> </ul>
Mirrors	27	<ul style="list-style-type: none"> <li>• See Section <a href="#">11.10</a></li> </ul>
Highway Occupancy	28	<ul style="list-style-type: none"> <li>• <a href="#">67 Pa. Code, Chapter 441</a>, Publication RR-441</li> <li>• Design Manual, Part 2, PennDOT (<a href="#">Publication 13M</a>).</li> <li>• Guidelines for the Design of Local Roads and Streets, PennDOT (<a href="#">Publication 70M</a>).</li> <li>• Highway Occupancy Permit Handbook, PennDOT, (<a href="#">Publication 282</a>).</li> <li>• Highway Occupancy Permit Manual. (<a href="#">Publication 170</a>).</li> <li>• Roadway Construction Standards, PennDOT (<a href="#">Publication 72M</a>).</li> <li>• Traffic Signal Design Handbook, PennDOT (<a href="#">Publication 149</a>).</li> <li>• Traffic Signal Standards, PennDOT (<a href="#">Publication 148</a>)</li> </ul>
Municipal Waste Facilities	30	<ul style="list-style-type: none"> <li>• Highway Occupancy Permits, <a href="#">67 Pa. Code Chapter 441</a>.</li> <li>• <a href="#">Municipal Waste Facilities Review Program</a></li> </ul>
Snowmobile and All-Terrain Vehicle Roads	42	<ul style="list-style-type: none"> <li>• <a href="#">The Pennsylvania Vehicle Code. (75 Pa. C.S.)</a></li> <li>• Snowmobile and All-Terrain Vehicle Registration and Operation (<a href="#">17 Pa. Code, Chapter 51</a>)</li> </ul>
Closing State Highways for Special Events	43	<ul style="list-style-type: none"> <li>• <a href="#">The Pennsylvania Vehicle Code. (75 Pa. C.S.)</a></li> <li>• <a href="#">Official Traffic Control Devices. (67 Pa. Code Chapter 212)</a></li> </ul>
Turnback of Traffic Restrictions	44	<ul style="list-style-type: none"> <li>• Transfer of State Highway (Road Turnback) Program, Policies and Procedures Manual (<a href="#">Publication 310</a>)</li> </ul>
Turn Lane Guidelines	45	<ul style="list-style-type: none"> <li>• See <a href="#">Section 11.16</a></li> </ul>

**Definitions**

The following words and terms, when used in this chapter, have the following meanings, unless the context clearly indicates otherwise:

*ADT, average daily traffic* – The total volume of traffic during a number of whole days, more than 1 day and less than 1 year, divided by the number of days in that period.

*Advancing volume* – The total hourly volume of traffic approaching the intersection from the same direction as the turn movement under consideration (includes the turn volume).

*Advisory speed* – The recommended speed for vehicles operating on a section of highway based on the highway design, operating characteristics and conditions. When posted, the speed is displayed as a warning sign; that is, either a black-on-yellow or a black-on-orange sign.

*Angle parking* – Parking, other than parallel parking, which is designed and designated so that the longitudinal axis of the vehicle is not parallel with the edge of the roadway.

Corner sight distance –

- i. Available corner sight distance—The maximum measured distance along a crossing highway which a driver stopped at a side road or driveway along that highway can continuously see another vehicle approaching. For the purpose of measuring the available sight distance, the height of both the driver’s eye and the approaching vehicle should be assumed to be 3.5 feet above the road surface. In addition, the driver’s eye should be assumed to be 10 feet back from the near edge of the highway or the near edge of the closest travel lane if parking is permitted along the highway.
- ii. Minimum corner sight distance—The minimum required corner sight distance based on engineering and traffic studies, to ensure the safe operation of an intersection. The minimum value is a function of the speed of the approaching vehicles and the prevailing geometrics.

Crash –

- i. A collision involving one or more vehicles.
- ii. Unless the context clearly indicates otherwise, the term only includes those collisions that require a police report; that is, the collision involves one of the following:
  - Injury to or death of any person.
  - Damage to any vehicle involved to the extent that it cannot be driven under its own power in its customary manner without further damage or hazard to the vehicle, to other traffic elements, or to the roadway, and therefore requires towing.

Delineator – A retroreflective device mounted on the road surface or at the side of the roadway in a series to indicate the alignment of the roadway, especially at night or in adverse weather.

Department – The Department of Transportation of the Commonwealth.

Divided highway – A highway divided into two or more roadways and so constructed as to impede vehicular traffic between the roadways by providing an intervening space, physical barrier or clearly indicated dividing section.

85th percentile speed – The speed on a roadway at or below which 85 percent of the motor vehicles travel.

Engineering and traffic study – An orderly examination or analysis of physical features and traffic conditions on or along a highway, conducted in accordance with this chapter for the purpose of ascertaining the need or lack of need of specific traffic restrictions, and the application of traffic-control devices.

Expressway – A divided arterial highway for through traffic with partial control of access and generally with grade separations at major intersections.

Freeway – A limited access highway to which the only means of ingress and egress is by interchange ramps.

Grade – The up or down slope in the longitudinal direction of the highway, expressed in percent, which is the number of units of change in elevation per 100 units of horizontal distance. An upward slope is a positive grade; a downward slope is a negative grade.

Highway –

- i. The entire width between the boundary lines of every way publicly maintained when any part thereof is open to the use of the public for purposes of vehicular travel.
- ii. The term includes a roadway open to the use of the public for vehicular travel on grounds of a college or university, or public or private school, or public or historical park.

Local authorities –

- i. County, municipal and other local boards or bodies having authority to enact regulations relating to traffic.
- ii. The term includes airport authorities except when those authorities are within counties of the first class or counties of the second class.
- iii. The term also includes State agencies, boards and commissions other than the Department, and governing bodies of colleges, universities, public and private schools, public and historical parks.

MUTCD – The current edition of the *Manual on Uniform Traffic Control Devices*, as adopted by the Federal Highway Administration (FHWA), and available on the FHWA website.

Narrow bridge or underpass – A bridge, culvert or underpass with a two-way roadway clearance width of 16 to 18 feet, or a roadway clearance less than the width of the approach travel lanes.

Numbered traffic route – A highway that has been assigned an Interstate, United States or Pennsylvania route number, consisting of one, two, or three digits, sometimes with an additional designation such as business route, truck route or other similar designation.

One-lane bridge or underpass – Any bridge or underpass with a clear width between the curbs, parapets, bridge railings, trusses, etc., of less than 18 feet and which does not satisfy the definition of “narrow bridge or underpass.” In addition, if the geometrics of the approach roadway, the skew of the bridge, etc., create a situation where the effective roadway width on the bridge or through the underpass may be less than 18 feet, consider the bridge or underpass to be a one-lane facility.

Operational analysis – The analysis of transportation operations utilizing an approved traffic engineering software package as prescribed in Chapter 12 of PennDOT Publication 46, *Traffic Engineering Manual*.

Opposing volume – The total hourly volume of traffic opposing the advancing volume.

Percent turns – The percentage of the advancing volume that turns; equal to the turn volume divided by the advancing volume.

Procession –

- i. An organized group of individuals, or individuals with vehicles, animals or objects, moving along a highway on the roadway, berm or shoulder in a manner that interferes with the normal movement of traffic.
- ii. The term includes walks, runs, parades and marches.

Roadway – That portion of a highway improved, designed or ordinarily used for vehicular travel, exclusive of the sidewalk, berm or shoulder. If a highway includes two or more separate roadways, the term refers to each roadway separately but not to all roadways collectively.

School – A public, private or parochial facility for the education of students in grades kindergarten through 12.

School zone – A portion of a highway that at least partially abuts a school property or extends beyond the school property line that is used by students to walk to or from school or to or from a school bus pick-up or drop-off location at a school.

Special event – An assemblage, procession, special activity or other planned event held within the right-of-way of a public roadway, which requires its closure or partial closure, for which express written approval is needed from the Commonwealth and/or the affected municipality.



Speed – The legal speed limit of the roadway. If an engineering study has determined that the 85<sup>th</sup> percentile speed of the roadway is higher than the legal speed limit, then the 85<sup>th</sup> percentile speed may be used at the discretion of the Engineering District.

State highway – A highway or bridge on the system of highways and bridges over which the Department has assumed or has been legislatively given jurisdiction.

Traffic calming – The combination of primarily physical measures taken to reduce the negative effects of motor vehicle use, alter driver behavior and improve conditions for non-motorized street users. The primary objectives of traffic calming measures are to reduce speeding and to reduce the volume of cut-through traffic on neighborhood streets.

Traffic-control devices – Signs, signals, markings and devices consistent with this chapter placed or erected by authority of a public body or official having jurisdiction, for the purpose of regulating, warning or guiding traffic.

Traffic restriction – A restriction designated by a traffic-control device to regulate the speed, direction, movement, placement or kind of traffic using any highway.

Traffic signal –

- i. A power-operated traffic-control device other than a sign, warning light, flashing arrow panel, or steady-burn electric lamp.
- ii. The term includes traffic-control signals, pedestrian signals, beacons, in-roadway warning lights, lane-use-control signals, movable bridge signals, emergency traffic signals, firehouse warning devices, ramp and highway metering signals and weigh station signals.

Travel lane –

- i. A lane of a highway which is used for travel by vehicles.
- ii. A lane in which parking is permitted during off-peak hours but is restricted for use as a travel lane during peak hours to obtain greater traffic movement.

## Customer Service

One of the most frequent controversies that the Department gets involved in is the approval or disapproval of a traffic control device to solve a given safety or congestion problem. Sometimes when the Department's response is different than what the municipality wants, they become frustrated and turn to their legislators. The legislators in turn contact the Secretary or one of the assistants for intervention.

The Department's goal is to minimize these controversies and reach good solutions to complex and emotional concerns. This is difficult because, in these situations, the Department has two customers to serve — the municipality and the driving public. The key is to find solutions that the municipality can embrace and will benefit the driving public.

Therefore, each Engineering District should have an established process for those situations where a municipality and the District Traffic Unit disagree on how to address these issues. As a minimum, the District Executive needs to be directly involved in reaching a satisfactory solution, and if it cannot be resolved at the District level, the issue will be addressed by the Director of the Bureau of Maintenance and Operations.

### Situations to Avoid

The following are situations that the Department wants to avoid in the future:

1. A signalized intersection with left-turn lanes of adequate length where a municipality wants either a separate left-turn phase or a protected/prohibited left-turn phase because of a documented history of near hits or a substantial number of non-reportable crashes that would be susceptible to correction by this treatment. In some cases, the Department turns down the request solely because it does not meet the conflict factor criteria, even though the introduction of the requested left-turn phase will not plunge the intersection into Level of Service E and the municipality is willing to accept the additional delays to improve safety.
2. The denial of a municipal request that does not quite meet the warrant threshold for reportable crashes, but where the municipality can justify their request by providing verifiable documentation that a significant number of non-reportable crashes have occurred that would be susceptible to correction by the approval of the request. (Note: §212.106(c) and §212.302(b), respectively allow the use of non-reportable crashes for multi-way stop control and traffic control signals.)
3. An intersection with an obvious sight distance problem that cannot easily be remedied in a timely fashion, which is not taken into consideration when determining whether a traffic control device should be installed.
4. Prohibiting traffic from using a wide, paved shoulder (that presently is in good condition) to turn right at a congested intersection because the shoulder actually is structurally inadequate or will be damaged, and there are no immediate future plans to upgrade the shoulder so that traffic can use it.
5. A catastrophic or high profile crash at a site where the municipality, legislators, or the media expect action, but the Department's only response is the installation of an additional warning sign that has minimal safety benefits, thereby leaving the customers frustrated. However, if the characteristics of the crash indicate that driver error was the predominant cause and that changing the roadway would have little impact or safety benefits, the Engineering District needs to do a more effective job communicating this with the customers. In addition, consider partnerships with the enforcement community to initiate targeted, high profile, well-publicized enforcement operations.

#### Using Engineering Judgment

[§212.4\(b\)\(2\)](#) of Chapter 212, Official Traffic Control Devices, allows flexibility to exercise sound engineering judgment based upon a combination of all data sources in making a determination of how best to solve a problem. Therefore, a determination need not be solely based upon the specific criteria in the warrants, if it can be substantiated by other valid factors.

Warrants in Chapter 212 provide the threshold for consideration of the installation of a traffic control device, but are not a substitute for engineering judgment. Moreover, the fact that a warrant for a particular traffic control device is met is not conclusive justification for the installation of the device.

There are two key principles to follow when applying sound engineering judgment as it relates to the application of a traffic control device that does not meet the specified warrants:

1. The site has at least one significant attribute or characteristic that warrants do not adequately consider, and the application of a specific traffic control device will most likely improve safety or otherwise be beneficial. In this case, there can be no degradation in safety, and if there would be small, undesirable impacts on traffic flow, delay, and other parameters, the municipality must understand and concur with the trade-off.

2. The application will not result in a significant precedent-setting situation that can be broadly applied in the area with an overall negative impact on safety. An example would be the approval of a multi-way stop control in a community to control speed, since studies document that motorists tend to increase their mid-block speeds between multi-way stops and the overall compliance with STOP signs degrades, thereby increasing the potential for crashes at intersections with legitimate stop control.

When using [§212.4\(b\)\(2\)](#), the basis for using sound engineering judgment needs to be documented in writing and placed in the project file.

#### Unconventional Solutions

In addition to conventional traffic control devices, Engineering Districts should consider other solutions including an increase in enforcement or the judicious application of appropriate traffic calming devices. Traffic calming measures that may be applied include raised crosswalks, speed tables (not bumps), roundabouts, bulb-outs, diverters, chicanes, and other such measures. Most of these measures would only be appropriate for local roads and collectors that are not numbered traffic routes and are in a residential area or business district.

#### **Traffic Impact Studies – Seal by a Professional Engineer**

Developers of major site developments generally provide traffic access and impact studies with their applications for driveway permits. This includes all high-volume driveways and those medium volume driveways where the site-generated traffic could adversely affect roadway capacity or safety, as defined in Publication 441, *Access to and Occupancy of Highways by Driveways and Local Roads*.

These studies serve as an effective tool for evaluating the effects of site-generated traffic on roadway network and for assessing the traffic needs for both developments and the transportation system. In most cases, consulting engineers who have training and experience in traffic and transportation engineering prepare these traffic impact studies. However, there have been cases where studies were prepared by individuals with backgrounds in other fields, such as, architecture, surveying, etc.

This matter has been reviewed by the State Registration Board for Professional Engineers who indicated that a traffic impact report must be sealed by a registered professional engineer when independent engineering judgment is required while conducting the study or analyzing the data. Therefore, the Department requires a registered professional engineer to seal all traffic impact studies submitted to the Department.

#### **Performing Engineering and Traffic Studies on Local Roads**

The Office of Chief Counsel has advised that it is inappropriate for the Department to perform engineering and traffic studies on local roads with Motor License Funds. In addition, performing these studies may expose the Department to additional tort liability.

The only exceptions are those cases in which the locals agree to enter into an agreement reimbursing the Department and the District can commit personnel to the effort without compromising work requirements on State highways. Therefore, it is acceptable to perform studies pursuant to agility agreements.

However, the Department should continue to provide guidance to municipalities on engineering and traffic study methodology and requirements. Many municipalities are not familiar with the requirements in the regulations and it is appropriate for the Department to provide technical advice.

## Release of Studies to the General Public

It is imperative that the Department keep all engineering and traffic studies as privileged information. Therefore, the Department should deny all requests from the general public for engineering and traffic study or a compilation of the results of the study.

The Torts Litigation Section of the Office of Attorney General, has determined that engineering and traffic studies should not be made available to the general public because of the provisions of [§3754](#) of the Vehicle Code (75 Pa. C.S. §3754), as well as the provisions of federal law found at 23 U.S.C. §409.

Specifically, [§3754\(b\)](#) of the Vehicle Code (relating to confidentiality of reports) provides that in-depth crash investigations and other safety study records and information is prohibited in any legal action or proceeding and it protects such investigations and studies from disclosure in the discovery process as well, so that the Department can object to their release even if subpoenaed.

The language in the Federal Highway Law, found at [23 U.S.C. §409](#) even more broadly provides:

“Notwithstanding any other provision of law, reports, surveys, schedules, lists, or data compiled or collected for the purpose of identifying, evaluating, or planning the safety enhancement of potential accident sites, hazardous roadway conditions, or railway-highway crossings, pursuant to sections 130, 144, and 152 of this title or for the purpose of developing any highway safety construction improvement project which may be implemented utilizing Federal-aid highway funds shall not be subject to discovery or admitted into evidence in a Federal or State court proceeding or considered for other purposes in any action for damages arising from any occurrence at a location mentioned or addressed in such reports, surveys, schedules, lists, or data.”

The clear purpose of both the state and federal statutory language is to encourage the investigation and study of potentially hazardous roadways so that improvements can be made. To that end, both the General Assembly of the Commonwealth and the United States Congress have provided that such investigations and studies can be withheld, not only from use as evidence in legal proceedings, but even from mere disclosure to other parties in litigation.

A citizen may be seeking access to an engineering and traffic study for purposes other than bringing a lawsuit against the Department. However, the Department could not logically object to the disclosure of studies in litigation if it otherwise releases such information to the public at large. Moreover, it is doubtful that any court would agree that information could be withheld in a lawsuit when that information is otherwise made available to the general public.

Yet both the state and federal legislatures have acted so that access to such information and studies is not available to parties involved in a lawsuit. Therefore, it must have been the intent of both the state and federal legislatures that such information and analysis would also not be available to the general public.

While the Department is reluctant to deny citizen access to any study funded with public funds, the general release of these kinds of studies could so greatly disadvantage the Department in litigation as to discourage the effort to undertake them. The result could be that studies are not undertaken for fear of their use in litigation, and that hazards go unidentified and the traveling public is put at additional risk. Studies, however, can be released to PennDOT business partners conducting transportation planning as long as the business partner agrees to maintain confidentiality.

To emphasize the Department’s position, the Engineering District shall place the following notice in the front of any traffic engineering and safety study completed by or for the Department.

## Confidential – Traffic Engineering and Safety Study

This document is the property of the Commonwealth of Pennsylvania, Department of Transportation. The data and information contained herein are part of a traffic engineering and safety study. This safety study is only provided to those official agencies or persons who have responsibility in the highway transportation system and may only be used by such agencies or persons for traffic safety-related planning or research. The document and information are confidential pursuant to 75 Pa. C.S. §3754 and 23 U.S.C. §409 and may not be published, reproduced, released or discussed without the written permission of the Pennsylvania Department of Transportation.

In addition, the Engineering District shall affix the following stamp on each page of any traffic engineering and safety document that is released.

This traffic engineering and safety study is confidential pursuant to 75 Pa. C.S. §3754 and 23 U.S.C. §409 and may not be disclosed or used in litigation without written permission from PennDOT.

Each Engineering District should have a minimum of two stamps for each of the above.

### Laws, Regulations, Forms and Other Publications

Other useful sources of information include the following:

1. *Manual on Uniform Traffic Control Devices (MUTCD)*, 2009 Edition, FHWA – available at <http://mutcd.fhwa.dot.gov/index.htm>.
2. *Mechanical Electrical, and Electronic Speed Timing Devices*. (67 Pa. Code Chapter 105). See <http://www.pacode.com/secure/data/067/chapter105/chap105toc.html>
3. *Municipal Traffic Engineering Certification*. (67 Pa. Code Chapter 205). See <http://www.pacode.com/secure/data/067/chapter205/chap205toc.html>.
4. Engineering and Traffic Study Forms are available at ([p:\penndot\\_shared\Engineering and Traffic Studies\TE Forms](p:\penndot_shared\Engineering and Traffic Studies\TE Forms))
5. *Pavement Marking Standards, that* specify the types, dimensions, and locations of pavement markings (TC-8600), snowplowable raised pavement markers (TC-8602), and delineators (TC-8604) – available at <ftp://ftp.dot.state.pa.us/public/PubsForms/Publications/PUB%2011M.pdf>.
6. *Roadside Design Guide*, 2002 Edition (AASHTO).
7. *Traffic Signal Design Handbook*. (PennDOT Publication 149).
8. *Vehicle Code (75 Pa.C.S.), Pennsylvania's Motor Vehicle Code – available at* [http://www.dot4.state.pa.us/vehicle\\_code/index.shtml](http://www.dot4.state.pa.us/vehicle_code/index.shtml).

The Bureau of Maintenance and Operations maintains a more comprehensive list of hyperlinks for traffic engineers at [P:\bhste\\_shared\hyperlinks\common-hyperlinks.doc](P:\bhste_shared\hyperlinks\common-hyperlinks.doc). Submit any suggestions for additions or changes to the list to the Chief, Traffic Engineering and Operations Division.

## 11.2 Approvals

### References

- a) The Pennsylvania Vehicle Code. (75 Pa. C.S.).
  - [§3307](#). No passing zones.
  - [§3308](#), One-way roadways and rotary traffic islands.
  - [§3313](#) Restrictions on use of limited access highways.
  - [§3331](#), Required position and method of turning.
  - [§3353](#), Prohibitions in specified places (parking, standing, stopping).
  - [§3754](#), Additional parking regulations.
  - [§3363](#), Alteration in maximum limits (speed limits).
  - [§3364](#), Minimum speed regulations.
  - [§3365](#), Special speed limitations.
  - [§3367](#), Racing on highways.
  - [§3541](#), Obedience of pedestrians to traffic-control devices and regulations.
  - [§4902](#), Restrictions on use of highways and bridges.
  - [§6109](#), Specific powers of department and local authorities.
  - [§6122](#), Authority to erect traffic-control devices.
  - [§6123](#), Erection of traffic-control devices while working.
  - [§6124](#), Erection of traffic-control devices at intersections.
- b) Official Traffic Control Devices. (67 Pa. Code Chapter 212).
  - [§212.5](#), Installation and maintenance responsibilities.
  - [§212.108](#), Speed limits.
  - [§212.114](#), Stopping, standing and parking.
  - [§212.701](#), Processions, assemblages and special activities.
- c) Municipal Traffic Engineering Certification, (67 Pa. Code Chapter 205).
- d) Traffic Signal Design Handbook (Publication 149).
- e) Pavement Marking Handbook.

### Department Approval on State Highways

The District Executive, an Assistant District Executive, or the District Traffic Engineer may issue or cancel permits or approvals for traffic restrictions and the installation and removal of traffic control devices on State highways and at the intersection of a State highway and local highways, providing:

- The individual has a Pennsylvania Professional Engineer's License, and

- Department regulations do not specify otherwise.

Moreover, [§212.5](#) of Publication 212 (relating to installation and maintenance responsibilities) defines what agencies are responsible for installing and maintaining traffic control devices.

### 11.3 Speed Restrictions

#### References

- a) The Vehicle Code. (75 Pa. C.S.).
  - [§3368](#), Speed Timing Devices.
  - [§6109](#), Specific powers of Department and local authorities.
- b) Mechanical, Electrical and Electronic Speed-Timing Devices ([67 Pa. Code Chapter 105](#)).

#### Crash Rates

In accordance with [§212.108\(b\)](#) of Chapter 212 (relating to engineering and traffic studies), speed limits should be established based on the 85th-percentile speed unless:

- there are sight distance restrictions (stopping and corner sight distance), or
- the majority of crashes are related to excessive speed and the crash rate is greater than the applicable rate in the most recent high-crash rate or high-crash severity rate table.

Information on calculating crash rates and the homogeneous crash rate tables is included in Item 2(1) in the Appendix of Publication 212.

To determine if a crash was related to excessive speed, consider the causation factors in the following two lists, recognizing that this is only a tool and is not intended to be all-inclusive:

#### Probably Related to Excessive Speed

- |    |                                       |
|----|---------------------------------------|
| 21 | Tailgating                            |
| 25 | Failure to heed stopped school bus    |
| 26 | Failure to heed pedestrian on roadway |
| 27 | Failure to heed stopped vehicle       |
| 29 | Passing in a no-passing zone          |
| 30 | Careless passing                      |
| 38 | Speeding in excess of posted limit    |
| 39 | Too fast for conditions               |
| 47 | Driver lost control                   |

#### May or May Not Be Related to Excessive Speed

- |    |  |
|----|--|
| 02 | Driver drinking (charged or indicated)       |
| 19 | Failure to respond to traffic control device |
| 22 | Proceeding without clearance after stopping  |

23	Reacting to an obstacle on the roadway
34	Sudden slowing/stopping
36	Making improper entrance to highway
37	Making improper exit from highway
42	Driving on the wrong side (part. / fully)
43	Careless lane change
46	Hit and run
48	Other operator performance failure
49	Forced movement
75	Sudden entrance by non-drinking pedestrian
76	Sudden entrance by bicyclist

### Electronic Ball Bank Instruments

An electronic digital ball bank instrument is available that provides consistent results with the standard curved-tube ball bank indicators historically used by the Department. The Department evaluated one from the Rieker Instrument Company, Inc., but other manufacturers may have similar units.

The electronic model reviewed by the Department has a number of advantages over the curved tube models, including the following:

- It has a programmable trigger that can be set at any degree, including the 12-, 14-, or 16-degree readings (see page 2-20), that will cause a red light or an audible warning to activate when the reading exceeds the preset value.
- After a test run, the operator can press the function button and display the high reading on the curve, and also link the unit to a printer for the file.
- It should not be necessary to have a passenger to observe the reading, thereby making personnel more productive.

Engineering Districts are encouraged to consider purchasing an electronic model. However, when using an electronic model, it is very important to maintain a smooth turn to obtain accurate results.

### 25-mph Speed Limit in “Residence Districts”

On December 21, 1998, Act 1998-151 added §3362(a)(1.2) to the Vehicle Code (relating a 25-mph speed limit in residence districts). This new section provides for a statutory 25-mph speed limit in a “residence district” if the highway is functionally classified by the Department as a local highway, and the highway is not a numbered traffic route as defined in §102 (relating to definitions). The purpose of the change is to eliminate the need for an engineering and traffic study on many of the highways under control of local authorities.

This change has major impacts since, in 1999, approximately 84,000 of the 119,000 miles of highway in the Commonwealth were functionally classified as “local highways.” This classification included 70,883 mile (96 percent) of the highways under the jurisdiction of local authorities, and 8,817 miles (22 percent) of the State highways.



Two additional factors complicate matters. First, the definitions of residence district and urban district sometimes overlap with resulting conflicts in statutory speed limits. Second, the definitions in the Vehicle Code for residence district and the subsequently referenced business district previously had very few applications and are subject to interpretation.

The Vehicle Code defines the following terms:

*“Residence district”* – The territory contiguous to and including a highway not comprising a business district when the property on the highway for a distance of 300 feet or more is in the main improved with residences or residences and buildings in use for business.

*“Business district”* – The territory contiguous to and including a highway when within any 600 feet along the highway there are buildings in use for businesses or industrial purposes, including but not limited to hotels, banks, or office buildings, railroad stations and public buildings which occupy at least 300 feet of frontage on one side or 300 feet collectively on both sides of the highway.

*“Urban district”* – The territory contiguous to and including any street which is built up with structures devoted to business, industry or dwelling houses situated at intervals of less than 100 feet for a distance of a quarter of a mile or more.

#### Interpretations and Guidelines

- a) “Residence district” is the territory contiguous to and including a highway that has structures:
  - i. designed for use as residences and having direct access to the highway, and
  - ii. which cumulatively accounts for at least 150 feet of frontage on one or both sides of the highway within every 300-foot section of the highway.
- b) If a section of highway qualifies as both a residence district and an urban district, the local authorities shall determine the appropriate speed limit by the erection of signs at maximum one-half mile intervals as required by §3362(b) (relating to posting of speed limits).
- c) Short sections of reduced speed limits less than 500 feet in length should not be posted because they cannot be enforced per §3368(e) (relating to distance required for mechanical, electrical and electronic devices).
- d) §6109(e) (relating to engineering and traffic investigations required) was amended to delete the requirement for an engineering and traffic study when establishing a 25 mph speed limit in a residence district. However, nothing prohibits local authorities on highways under their jurisdiction, or the Department on State highways, from completing an engineering and traffic study and thereby justifying a different speed limit.
- e) As allowed under §6109(d) (relating to prior approval of the department), your Engineering District should approve all speed limits on State highways before a local authority is allowed to erect speed limit signs.
- f) Except in cities of the first and second class, on State highways the Engineering Districts should confirm that a location is a qualifying residence district prior to approving 25 mph speed limits and authorizing local authorities to erect speed limit signs. The District may, at their discretion, perform an engineering and traffic study and reach consensus with the municipality on any other appropriate speed limit determined from the study.

## 65-mph Speed Limits

§3362 and §6110 of the Vehicle Code respectively address the maximum speed limit on State highways and on highways under the jurisdiction of the Pennsylvania Turnpike Commission.

In light of recent legislative changes and a commitment that the Department would re-study some of the existing 55-mph sections of rural freeways, Engineering Districts (or the Pennsylvania Turnpike Commission, as applicable) should establish 65-mph speed limits on all freeways unless there is strong justification for leaving it at a lower speed limit. In particular, Engineering Districts were requested to review the following sections of highway for possible 65-mph speed limit:

- I-70 in Fulton and Bedford Counties
- I-76 between Exits 48 and 57 (PA Turnpike)
- I-78 between Exits 29 and 60
- I-95 in Bucks County
- I-276 between Exits 328 and 358 (PA Turnpike)
- I-476 between Exits 20 and 31 (PA Turnpike)
- US 30 from PA 24 in York County to PA 340 in Lancaster County
- US 222, the Kutztown Bypass
- US 322 between Lewistown and Seven Mountains
- US 322 between the Clarks Ferry Bridge and Harrisburg
- PA 33 from I-78 to I-80

In the review, Districts should consider the following:

1. One goal of establishing speed limits is to minimize the speed variance. An article written by Nicholas J. Garber and Ravi Gadiraju entitled, "*Factors Affecting Speed Variance and Its Influence on Accidents*" (Transportation Research Record 1213), is available at [P:\bhste\\_shared\traffic\\_restrictions\speed\\_limits\Factors Affecting Speed Variance and Its Influence on Accidents.doc](P:\bhste_shared\traffic_restrictions\speed_limits\Factors Affecting Speed Variance and Its Influence on Accidents.doc). In the article, the authors note that crash rates increase with an increase in the speed variance, and speed variance will be minimized if the posted speed limit is 5 to 10 mph lower than the design speed. The article also notes that drivers will drive at increasing speeds as the roadway geometric characteristics improve, regardless of the speed limit.
2. The average fatality rate on freeways is about one-third of the fatality rate on conventional highways. Therefore, by raising some of the speed limits, some motorists may change their travel patterns from conventional highways to the safer freeways, thereby improving the overall safety.
3. A 60-mph speed limit could legally be established on a freeway under §3363 of the Vehicle Code (relating to alteration of maximum limits) providing speed limit signs were posted at maximum intervals of one-half mile. However, Districts should not use 60-mph speed limits because the difference between a 65-mph and a 60-mph speed limit is minor, and most speed limits are currently posted at 10-mph increments, e.g., 25, 35, 45, 55 and 65 mph.
4. Maintenance concerns should normally not be a controlling factor to reduce speed limits, but rather the District should address the maintenance problems, and do so as soon as possible. In addition, either advisory speed limits or a short section of reduced regulatory speed is preferred for

isolated problem locations in lieu of establishing an extensive length of reduced regulatory speed limit. The goal is to avoid unrealistic speed limits, which are likely to breed disrespect on the part of the motorists.

5. The [Chapter 11 Appendix](#) lists study elements that Engineering Districts should consider when determining if the speed limit on a freeway should be reduced.

#### Installation of Signs

Speed limit signs should be posted beyond each interchange for both 55-mph and 65-mph speed limits. When a 55-mph section of highway is over 5 miles in length, Districts should install the "NEXT \_\_\_\_" (R2-9) sign beneath the first two 55-mph Speed Limit (R2-1) signs (typically one on the left and one on the right side of the roadway) to help motorists realize the extent of the restriction, e.g., "NEXT 15 MILES."

#### Issuance of Permits

The 65-mph speed limit is a statutory speed limit on freeways. However, Districts are asked to continue the current practice of issuing permits for the 65-mph speed limits instead of the reduced 55-mph speed limits. This policy maintains the philosophy that without a speed limit permit, the speed limit is 55 mph.

In order to change a speed limit on any freeway, please perform the following:

- Complete an engineering and traffic study.
- Provide an informational copy of the speed limit permit to the Traffic Engineering and Operations Division (Bureau of Maintenance and Operations) and identify the approximate effective posting date.
- Update the information in the Excel™ database at [P:\bhste\\_shared\traffic\\_restrictions\speed\\_limits\65mph Speed Limits.xls](P:\bhste_shared\traffic_restrictions\speed_limits\65mph Speed Limits.xls).
- Modify the speed limit in the RMS "432 screen" using the offset breaks that are already defined in the system (Districts cannot change the offset breaks, which means that speed limits will essentially be "segment level" data).

### **Legal Challenges**

On October 24, 1980, the Superior Court of Pennsylvania, in the [Commonwealth of Pennsylvania v. James Aiello](#), ruled that a speed limit established and posted prior to July 1, 1977 (the effective date of Title 75, the basis for the current Vehicle Code does not need to be supported by an engineering and traffic study. (Note, this also applies to other engineering studies where regulations now exist.)

Other court decisions make it quite clear that warning signs are not necessary to advise that a specific speed detection device is in use to enforce speed limits. For example, there is no need for signs to indicate that aircraft, radar, VASCAR-plus, etc. are used. However, in accordance with [§3368](#) of the Vehicle Code (relating to speed timing devices), all mechanical, electrical and electronic devices need to be of an approved type (see [67 Pa. Code Chapter 105](#)).

In addition, there is also a court decision indicating that municipalities do not need to enact an ordinance to use VASCAR-plus.

The FCC has modified the license requirements for radar units. If the organization using radar already holds a two-way radio license, an additional license for the radar units is not required. Although the FCC no longer requires the radar units to be calibrated every 6 months, it is recommended that the District calibrate radar units at least once a year in order to keep the equipment in its best possible condition.

## 11.4 No-Passing Zones

### Warrants

National warrants for no-passing zones are included in Section 3B.02 of the *MUTCD*, but additional warrants for the Commonwealth are included in [§212.202](#) of Publication 212.

#### Additional PennDOT Warrants for No-Passing Zones

1. In advance of a divided highway or an obstruction such as a bridge support pillar, a channelizing island or a safety zone that separates the two lanes of traffic.
2. In advance of, and on or within any bridge, tunnel or underpass that is designated as a narrow bridge or underpass.
3. In advance of a STOP (R1-1) sign, YIELD (R1-2) sign, or traffic signal.
4. In advance of an intersection where passing may be undesirable due to the high number of crossing or turning movements.
5. In advance of and within a school zone.
6. In areas where an analysis of vehicle crashes shows an unusually high number of passing-related crashes.
7. In areas where the roadside development includes many driveways and intersections where passing would create frequent potential conflicts.
8. At locations where the roadway width is very restrictive, shoulders are nonexistent or in poor condition, the roadway cross-section has an excessive crown, or obstacles are close to the roadway.
9. In areas where traffic volumes are very heavy and there would be very limited opportunities for motorists to pass other vehicles.
10. At locations where a passing zone would otherwise be less than 600 feet in length.
11. At locations where engineering judgment indicates that allowing passing is undesirable because a better passing area exists farther ahead.

When establishing a no-passing zone under Warrants 1 through 5, start the no-passing zone at a minimum distance in advance of the specific physical feature in accordance with [Exhibit 11-2](#).

#### **Exhibit 11-2 Advance Distance for No-Passing Zones**

Speed Limit or 85th-Percentile Speed (mph)	Advance Distance (feet)*
35 or less	300
40	350
45	400
50	450
55	500

\* These advance distances apply to PennDOT's Warrants 1 through 5 on the previous page.

## Establishment of No-Passing Zones through Intersections

Engineering Districts should review all passing zones through intersections and areas with major commercial driveways on a case-by-case basis to consider the establishment of a no-passing zone.

Two problems exist for the driver on a side road or driveway:

1. A passing vehicle from the left may be obscured by another vehicle from the left that is turning right.
2. If turning to the right, a driver may not anticipate a vehicle approaching in that lane.

In either case, if the driver on the side approach does not see the passing vehicle, there is a high potential for a crash.

When establishing a no-passing zone, it should begin at a minimum distance equal to the appropriate value in [Exhibit 11-2](#).

## 11.5 One-Lane and Narrow Bridges and Underpasses

### General

The purpose of this section is to establish Department guidelines to provide safe, efficient and practical traffic control at narrow and one-lane bridges on two-lane, two-way highways. These guidelines apply not only to structures normally thought of as “bridges,” but also to any other restricted width areas such as tunnels, underpasses or culverts.

### Suggested Traffic Control

An advance warning sign informing the driver of the type of restriction; i.e., a NARROW BRIDGE (W5-2) sign, NARROW UNDERPASS (W5-2A) sign, ONE LANE BRIDGE (W5-3) sign, or ONE LANE UNDERPASS (W5-3A) sign, should ordinarily be installed in advance of one-lane and narrow bridges and underpasses.

Install an Advisory Speed (W13-1) plaque when the safe speed on a narrow or one-lane structure is less than the legal speed limit. In these cases, determine the advisory speed by an engineering and traffic study.

The advance warning sign should ordinarily be located a minimum distance in advance of the structure in accordance with Condition B in [Exhibit 2-6](#). Since drivers may need to stop at one-lane structures to allow on-coming traffic to clear the structure, use the advance distance to decelerate to “0 mph.” Increase the advance distances as necessary to fit field conditions.

Always install a Left Clearance (OM-3L) marker and Right Clearance (OM-3R) marker on the left and right bridge abutments, respectively. Position these markers to the greatest extent possible, so that the inside edge of the marker is in line with the inner edge of the obstruction.

On roadways with centerline pavement markings, verify that a no-passing zone exists in advance of the structure in accordance with Section [11.4](#) and [Exhibit 11-2](#). On narrow structures, continue the no-passing zone across and at least 200 feet beyond the structure.

For one-lane bridges and underpasses, discontinue any centerline pavement markings between the two locations on the approaches where it is desirable for approaching vehicles to wait for oncoming traffic. These locations should typically be 100 to 150 feet before the abutments, but lesser distances may be necessary to improve visibility between the two approaches.

On roadways with centerline pavement markings but typically without edge lines, it is desirable to install edge lines on both sides of the roadway on the bridge and on both approaches beginning a distance near the advance warning sign.

**Optional Traffic Control**

- a) Install additional delineation on the approaches to a narrow or one-lane bridge or underpass to create a “funneling effect.” Base the need for the additional delineation on an engineering study that takes into account roadway width, approach width, ADT, traffic speed, crash experience, etc. In addition, if the bridge or underpass is greater than 100 feet in length, install barrier-mounted delineators on both sides of the bridge at 50-foot intervals.
- b) Install Yield (R1-2) and TO ONCOMING TRAFFIC (R1-2A) signs on both ends of one-lane bridges or underpasses. When these signs are used, also install Yield Lines at the appropriate location.
- c) Install traffic signals on the approaches of one-lane bridges or underpasses when the bridge/underpass carries an exceptionally heavy volume of traffic or when it is not always possible for a driver on one approach to see vehicle on the opposite approach. Use traffic detectors, Signal Ahead (W3-3) signs, and stop lines in conjunction with traffic signals.

**11.6 Angle Parking**

**General Criteria**

Although businesses generally like angle parking because it provides approximately twice as many parking spaces as provided by parallel parking, there are safety concerns because of limited sight distance when patrons are backing out of the stalls. This is especially difficult when there is a mix of vehicles such as small cars and large SUVs. [§212.114\(b\)](#) of Publication 212 establishes the following minimum criteria to authorize angle parking on any street or highway in the Commonwealth:

- 1. The parking and maneuver area equals or exceeds the distance indicated in [Exhibit 11-3](#).

**Exhibit 11-3 Diagonal Parking Minimum Maneuver Area**

Parking Angle (degrees)*	Minimum Parking Maneuver Area (feet)**
30	26
45	30
60	37
90	43

\* The angle that vehicles on the nearest travel lane need to turn to the right to park in the center of a parking stall.

\*\* The perpendicular distance between the right edge of the nearest travel lane and the front edge of the parking stalls.

2. Parked vehicles do not adversely affect the available intersection sight distance.
3. Additional travel lanes are not required for the existing traffic volumes to achieve a satisfactory level of operation.
4. Parking stalls will be adequately marked and spaced.
5. Pedestrian/bicycle activity is minimal within the parking maneuver area.

### Reevaluation of Existing Angle Parking

Federal policy currently allows the retention of angle parking if, in the judgment of the Division Administrator, there will not be adverse effects on street capacity and safety.

[§212.114](#) of Publication 212 (relating to stopping, standing and parking restrictions), it defines criteria for the establishment of new angle parking and the retention of existing angle parking. Based on the criteria, use the following procedure to evaluate the possible retention of angle parking within the limits of future federal-aid project:

1. Compare the parking-related crash rate within the area of existing angle parking to the rate on a similar portion of the same street or other similar streets with parallel parking. If the rate is substantially greater within the area with angle parking, eliminate the angle parking.
2. Perform a capacity analysis on the intersection or roadway section that includes the angle parking. If the extra width required to facilitate angle parking is needed by through and/or turning vehicles in order to allow the intersection or roadway to operate at LOS C or better, eliminate the angle parking.
3. If the project under consideration includes traffic signal interconnection, determine the effect of angle parking on vehicle progression. Eliminate the angle parking if the number of expected parking turnovers coupled with the design of the angle parking and maneuver area will create significant platoon dispersion during the peak hours.

### Back-In Angle Parking

Because of safety concerns involving conventional angle parking, many states are using back-in angle parking. [Exhibit 11-4](#) shows an example of back-in angle parking as used in Pottstown. Although back-in angle parking is different, backing into stalls is common in parking lots, and it is much easier than parallel parking. Some of the reported advantages of back-in angle parking versus “pull-in” angle parking include:

- Less maneuver space required.
- No blind backing into traffic.
- Better visibility of bicycles.
- Curbside loading.
- Vehicle doors open towards curb.
- Easy and safe exit from space.

It is also true that back-in angle parking is similar to backing into parallel parking space, but with fewer movements.

**Exhibit 11-4 Back-In Angle Parking**

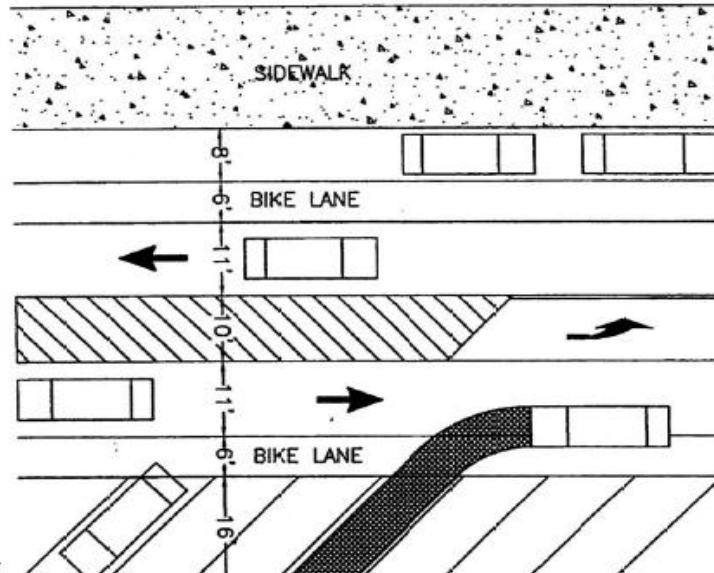

Therefore, if a municipality requests to use back-in angle parking, the Engineering District should consider the option providing parked vehicles would not adversely affect the available intersection sight distance and additional travel lanes are not required for the existing traffic volumes to achieve a satisfactory level of operation.

If using back-in angle parking, install special BACK-IN ANGLE PARKING ONLY signs along the roadway. (This would be a special parking-series sign with green legend and border on a white background.)

**11.7 Weight and Size Restrictions**

**References**

- Authorization to Use Highway Posted Due to Traffic Conditions ([67 Pa. Code Chapter 193](#)).
- Engineering and Traffic Study Form TE-109 ([Restrictions as to Weight and Size Based on Condition of Highway or Bridge](#))
- Hauling in Excess of Posted Weight Limit ([67 Pa. Code Chapter 189](#))
- Official Traffic Control Devices (67 Pa. Code Chapter 212, Publication 212).
- Maintenance Manual, Chapter 15, (Publication 23).
- Special Hauling Permit Manual, (Publication 31).
- Vehicle Code (75 Pa. C.S.)



- §4902, Restrictions on use of highways and bridges.
- §6109, Specific powers of Department and local authorities, specifically subsections (a)(7) and (a)(13).

### Restrictions Based on Condition of Highway or Bridge

§§4902(a), 6109(a)(7), and 6109(a)(13) of the Vehicle Code authorizes the Department on State Highways, and local authorities on highways under their jurisdiction, to prohibit the operation of any types of vehicles or vehicles with designated loads or impose restrictions as to the weight or size of any vehicles whenever it is determined that a highway or bridge may be damaged or destroyed by vehicles. Weight restrictions may be temporary or seasonal, especially during the spring.

Studies for weight restrictions established due to the condition of a highway or bridge are conducted by District Maintenance personnel for highways and District Bridge personnel for bridges.

In order to establish a weight or size restriction based on the condition of a highway or bridge, an engineering and traffic study in accordance with [§212.117 of Publication 212](#) (relating to weight, size and load restrictions) must be conducted and findings documented on an Engineering and Traffic Study Form, [TE-109](#) as also indicated in the Maintenance Manual, Publication 23, Chapter 15.

### Restrictions Based on Traffic Conditions

§4902(b), and §6109(a)(7) and (a)(13), of the Vehicle Code authorizes the prohibition of vehicles on highway or bridge if they create a hazardous traffic condition or other safety factor. Further, [§212.117\(d\) of Publication 212](#) (relating to weight and size restrictions based on traffic conditions) indicates that traffic may be prohibited or restricted by weight or size of vehicle, or kinds or classes of vehicles, if any of the following indicate that the movement of certain vehicles constitutes a safety hazard:

1. Horizontal and vertical alignment.
2. Prevailing traffic speeds.
3. Compatibility of the various types of traffic.
4. History of vehicle crashes.
5. Vehicle characteristics.

Studies for size restrictions and for restrictions due to traffic or safety reasons are usually conducted by District Traffic Engineering personnel. The actual restriction may include any of the following:

- Weight.
- Height, width or length of vehicles or their loads.
- Types of cargo.
- Speed or gearing.
- Stopping requirements.
- Specified travel lanes.
- Hours of operation.

Because of the myriad reasons that could justify a restriction based on traffic or safety reasons, a suggested study summary sheet does not exist. Therefore, the District Traffic Unit should clearly describe the justification for the restriction.

### Exceptions and Permits

Title 67, Chapter 189 regulates the use of highways with posted weight restrictions.

§4902(a) and (b) of the Vehicle Code authorizes the Department to exempt school buses, emergency vehicles, and vehicles making local deliveries or pickups from weight and size restrictions. Accordingly, the Department has defined “exempt vehicle” in [67 Pa. Code §193.2](#) (relating to definitions) as:

- i. Emergency vehicles.
- ii. School buses operating on regular routes.
- iii. Vehicles and combinations of governmental agencies and utilities or their contractors engaged in construction, maintenance or utility operations on or along a posted highway or in a location which can be reached only by a posted highway.

The Department has also defined “local traffic” in [67 Pa. Code §193.2](#) (relating to definitions) as:

*Vehicles and combinations going to or coming from a residence, commercial or industrial establishment, or farm located on or within the immediate vicinity of a posted highway or which can only be reached by a posted highway.*

Further §4902(c) of the Vehicle Code (relating to permits and security) authorizes the Department to issue permits for movements of vehicles of weights and sizes in excess of the restrictions.

Chapter 15 of Publication 23 and Chapter 8 of Publication 31 address posted roads and bridges and discuss appropriate laws and regulations. As part of the discussion on regulations, the two chapters present information on exempt vehicles and issuance of permits for overweight or oversize vehicles. Normally, the following District personnel approve permits for overweight or oversize vehicles:

- District Maintenance Unit – Highways posted due to condition of roadway.
- District Bridge Unit – Bridges posted due to condition of bridge.
- District Traffic Engineering Unit – Highways posted due to traffic conditions.

#### District Traffic Engineering Unit Responsibilities

- a) In conjunction with the issuance of permits for vehicles to use highways posted due to traffic conditions, the District Traffic Engineering Unit shall provide the District Permit Unit with a current list of any traffic restrictions issued under §4902(b) of the Vehicle Code (relating to restrictions based on traffic conditions) each time a new restriction is approved or an existing restriction is revised or canceled. These restrictions will normally be prohibitions on hills but may involve prohibitions on other roadways due to non-compatibility of various types of traffic or cargo.
- b) When the Traffic Engineering Unit receives an application for a permit to violate a restriction issued under §4902(b), they should:
  - Determine if the vehicle is an “exempt vehicle.”
  - If it is an exempt vehicle, return the application with a note stating that in accordance with Chapter 193, a permit is not required.

- If not an exempt vehicle, determine if the vehicle is “local traffic.” If the vehicle is “local traffic” and the application and check are in good order, the District Traffic Unit should review the application.
- c) If it is determined that the application is to be reviewed, the Traffic Engineering Unit should review the justification for the permit as supplied by the applicant and use good engineering judgment to determine if special authorization should be granted. Factors that may be considered in the decision should include:
1. The driver’s thorough knowledge of the conditions.
  2. The presence of a vehicle retarder (engine brake).
  3. Field demonstration of the vehicle’s braking capabilities.
  4. The benefits derived from specific countermeasures included in [67 Pa. Code §193.3\(d\)](#) (relating to restrictions).
- d) If the recommendation is to deny the application, return the application to the District Permit Unit with a written explanation so that the Permits Unit may notify the applicant.
- e) If the recommendation is to approve the application, the District Traffic Engineer should sign and date the bottom of the application. Specify any expiration date and attach all permit conditions to the approved application before returning the application to the District Permit Unit for processing.
- f) If approving the permit based on the driver’s knowledge of conditions, the permit should include the driver’s name and specify that it is only valid when the driver of the vehicle is the person whose name is on the permit.
- g) If approving the permit because of the vehicle or the braking or operating capabilities of an individual vehicle, the permit should identify the specific vehicle and indicate that the permit is only valid for that specific vehicle.
- h) If approving the permit because of both (f) and (g), the permit should include the driver’s name and the vehicle’s identification and should indicate that it is valid only for the identified vehicle and driver.

### **Oversize and Overweight Vehicle Traffic Control Plans (TCPs)**

The District Traffic Engineering Unit is not normally involved in the issuance of a permit for oversize and overweight vehicles and loads; however, [67 Pa. Code §179.11\(b\)](#) (relating to movement of buildings) does require the District approval of the traffic control plan (TCP) for house moves.

### **Bridge Crawl Speeds**

In 1998, the Department changed the policy on how District Bridge Units evaluate overweight permit applications. One of the changes was a requirement that the District Traffic Engineer grant a “safety approval” before approving any bridge crawl speed.

To assist the Districts, BOMO developed two traffic control plans (TCPs) as standard set-ups to maximize traffic safety and to help maintain the structural integrity of bridges. When either TCP in the [Chapter 11 Appendix](#) page 54 is included with the permit, the District Traffic Engineer's review and approval is no longer required. If a hauler wants to use an alternate TCP, the Bridge Unit must submit the alternate TCP to the District Traffic Engineer for approval.

This policy also places the following additional responsibilities on the hauler when bridge crawl speeds are involved:

- In addition to a private escort vehicle, provide a shadow vehicle with a sign to improve traffic safety.
- On freeways, provide a vehicle with an advance-warning message on a changeable message sign (CMS).
- Provide CB radios for communication between all vehicles (including any applicable Pennsylvania State Police officer), and at least one cellular telephone for emergencies.

Haulers will be responsible for making all arrangements of the specified traffic safety equipment. The Department will continue to arrange for PSP, but a minimum 48-hour advance notice is required.

If the Department or the PSP determines that a motor carrier has violated a bridge crawl speed, the Department should initiate administrative sanctions against the hauler.

## 11.8 Engine Brake Retarder Prohibition Policy

### Prohibition Request Procedure

In accordance with [§4103](#) of the Vehicle Code (relating to the promulgation of vehicle equipment standards), the Department has the sole authority to regulate vehicle equipment. The use and/or prohibition of the use of engine brake retarders falls under this authority. Therefore, any municipality that plans to prohibit the use of engine brake retarders must first obtain the permission of the Department in accordance with the following procedure:

1. The municipality requests authorization to enact an engine-brake-retarder prohibition, in writing, to the appropriate District Executive. The request must indicate if the prohibition request is for specific roadway(s), portion(s) of a municipality or the entire municipality.
2. The District Traffic Unit reviews the request in accordance with the criteria in [Criteria for Prohibition Approval](#) on page 24, and prepares a proposed written response for the District Executive's signature, advising the municipality of the Department's decision.
3. The municipality must subsequently enact an ordinance — PennDOT will not enact any engine-brake-retarder prohibitions. The municipality is also responsible for procuring, erecting and maintaining the required signing, using official signs in accordance with the requirements of Publication 236.
4. Enforcement of the engine-brake-retarder prohibition shall be the responsibility of the police agency that provides enforcement services for the municipality.

### Criteria for Prohibition Approval

In order to prohibit engine brake retarders; District Traffic Units shall ensure that all of the following are satisfied:

1. The roadway is not a limited access facility or a ramp exiting from a highway with a posted speed or 85th percentile speed of 55 mph or greater.
2. The average downhill grade does not exceed 4 percent within any 500-foot section of highway (i.e., the change elevation of the road is never greater than 20 feet in any 500-foot section of a downhill).

3. A reduced speed limit or reduced gear zone does not exist for trucks due to a hazardous grade determination.
4. The posted speed limit or 85th percentile speed is less than 55 mph.
5. There is no history of runaway truck crashes in the past 3 years.
6. There is no discernible pattern of rear-end crashes in the past 3 years where a truck was the striking vehicle.

## 11.9 Unsignalized Midblock Crosswalks

### Background

The installation of marked crosswalks has mixed reviews. While it is desirable to give guidance to pedestrians as to the safest locations to cross highways, studies have shown that pedestrian crash rates are sometimes higher in marked crosswalks than at other locations, perhaps because the markings give pedestrians a false sense of security.<sup>2,3</sup>

§3542 of the Vehicle Code (relating to right-of-way of pedestrians in crosswalks), requires motorists to yield the right-of-way to pedestrians within any marked crosswalk, but this does not always happen.

The 2009 *MUTCD* Section 3B.18 indicates that an engineering and traffic study should be performed before crosswalks are installed at location away from highway traffic signals or STOP signs.

In a recent survey, a majority of state traffic engineers indicated that midblock crosswalks are highly discouraged in their state and are rarely installed. Currently, only a few states have any warrants or guidance for midblock crosswalks. Therefore, the purpose of this policy is to establish the direction for future unsignalized midblock crosswalks on State highways, but it is not necessary to reevaluate existing midblock crosswalks. Although the application of this policy on local roadways may be desirable, the Department currently has no authority to force municipalities to comply with this policy.

Department approval is required prior to the installation of any midblock crosswalk on a State highway; however, the installation and maintenance of the pavement markings and signs for crosswalks is the responsibility of the local authorities in accordance with [§212.5\(b\)\(1\)\(v\)\(T\) of Publication 212](#) (relating to the installation of pavement markings for midblock crosswalks).

### Minimum Requirements for New Midblock Installations

1. Speed Limit. The posted speed limit is 35 mph or less.
2. Other Marked Crosswalks. The nearest marked crosswalk on the same roadway is over 300 feet from the proposed crossing.
3. Number of Pedestrian Crossings. To qualify for midblock crosswalks, the minimum number of pedestrians crossing the street within 150 feet of the proposed crossing during an average day should be 80 or more during any 1 hour, or 40 or more during each of any 4 hours. However, if there is a high concentration of children, elderly or disabled pedestrians crossing the roadway in the

---

<sup>2</sup> Herms, B. F., "Pedestrian Crosswalk Study: Accidents in Painted and Unpainted Crosswalks" (HRR 406). Highway Research Board, Washington, D.C., 1972.

<sup>3</sup> "City of Long Beach Crosswalk and Pedestrian Safety Study Final Report." Prepared by Willdan and Associates, Industry California, February 1986.

vicinity of the proposed crossing, then these pedestrian volume warrants may be reduced 50 percent.

4. **Traffic Volume.** The maximum traffic volume on the roadway is 10,000 ADT, except on two-lane roadways the maximum traffic volume may be 15,000 ADT. If a raised median or pedestrian refuge island exists where pedestrians are protected from vehicular traffic, the maximum traffic volume applies to each segment of the pedestrian crossing, but no more than three travel lane may be crossed without a raised median or pedestrian refuge island. In order to consider a refuge island, the minimum width of the refuge island is 4 feet from face-of-curb to face-of-curb, but the preferred minimum width is 6 feet. Islands should have a cut through ramp to accommodate wheelchair users.
5. **Parking Restrictions.** To improve visibility, parking is not permitted within 75 feet of the crosswalk, unless a 6- to 8-foot curb extension (sometimes referred to as bulb outs, bump outs, neck downs, sidewalk expansions, etc.) is in place to improve pedestrian visibility. If angle parking is present, any curb extension should place the curb at the inside edge of the parking lane. Curb extensions not only improve visibility between motorists and the pedestrians, but they also reduce the length of the crosswalk and the pedestrian exposure. However, curb extensions may impede drainage, street cleaning and winter maintenance operations, and create a formidable object.
6. **Sight Distance.** The available sight distance between an approaching driver and a person anywhere within the proposed crosswalk must satisfy the following minimum values, where both the eye and the object (i.e., the pedestrian) are assumed to be 3.5 feet above the roadway:

Speed Limit (mph)	Minimum Sight Distance for a Corresponding Grade (feet)		
	-6%	level	+6%
25	215	200	184
30	271	250	229
35	333	305	278

**Design Considerations**

Raised crosswalks may be used to improve the visibility of pedestrians. If used, the geometric design of raised crosswalks should be in accordance with Pennsylvania’s [Traffic Calming Handbook](#) (Publication 383). Pavement markings in advance of raised crosswalks should conform to the “typical pavement markings for speed tables or speed humps with crosswalks” in the Pavement Marking Standard (TC-8600).

Use the Pedestrian (W11-2) sign with the Diagonal Downward Pointing Arrow (W16-7P) plaque immediately prior to the crossing. The sign and plaque may be fluorescent yellow green in color. If a curb extension is used, install the W11-2 sign in the “bumped out area.”

Establish crosswalks at approximately 90 degrees to the roadway. For added visibility, the area of the crosswalk may be marked with wide white diagonal lines at a 45-degree angle to the edge of the crosswalk or with wide white longitudinal lines parallel to traffic. All crosswalk markings shall conform to the Pavement Marking Standard (TC-8600).

Consider using Yield Lines in advance of an unsignalized midblock crosswalk. If used, place Yield Lines 20 to 50 feet in advance of the crosswalk and install a YIELD HERE TO PEDESTRIANS (R1-5) sign immediately adjacent to the Yield Line. Yield Lines should conform to the Pavement Marking Standard (TC-8600).

Additional advance warning signs, internally illuminated overhead signs, In-Street Pedestrian Crossing (R1-6) signs, flashing beacons, etc., may supplement unsignalized midblock crosswalks. Yellow, pedestrian activated, in roadway warning lights may also be used providing traffic is not controlled by a STOP or YIELD sign (see Section 4L.02 of the *MUTCD*).

## 11.10 Mirrors

### General

The purpose of this policy is to establish uniform guidelines governing the approval and installation of mirrors located within the Department's right-of-way to improve the effective sight distance at intersections.

Flat mirrors are unacceptable for use at highway intersections because they provide a very small field of vision and require every observer's eyes to be at the proper location to effectively use the mirror. On the other hand, convex mirrors overcome the alignment issue and have been used along highways with some success despite the following inherent problems:

1. The image is distorted and reversed.
2. Vehicles appear to be much farther away than they actually are. For example, the image of an approaching car when it is 100 feet away from the mirror will be only about 2 to 2.5 inches wide on a standard convex mirror.
3. Mirrors require routine cleaning and are subject to vandalism.
4. Mirrors are fairly expensive (approximately \$250).
5. Unfamiliar drivers require time to become oriented when attempting to use a mirror.

### Minimum Warrants

The Department may authorize local officials, companies, associations or private individuals to install a mirror intended for traffic on a State highway, local roadway or a private driveway, providing the following conditions are met:

1. There are no viable alternatives for improving the sight distance or providing an alternate method of traffic control. Give consideration to redesigning or day-lighting the intersection; eliminating parking; reversing the stop control or providing multi-way stop control, signalization, one-way streets or other appropriate action; etc.
2. The total volume of the traffic on the mainline and on the side road (or driveway) approach to the "intersection" with the mirror is less than 500 vehicles per day.
3. If a public highway, the approach is controlled by a STOP (R1-1) sign.
4. The municipality, company, association or private citizen has agreed, in writing, to purchase, erect and maintain the mirror and the VEHICLES ARE CLOSER THAN THEY APPEAR (W14-11) sign in satisfactory condition; save harmless the Department in the event of an crash; and remove the mirror and sign if directed by the Department.

### Installation Guidelines

Convex mirrors are normally available at local glass dealers. As a minimum, they shall:

1. be designed for exterior use;
2. be made of “Plexiglas” or shatterproof glass;
3. have a minimum diameter of 36 inches; and
4. have a minimum radius of curvature of 80 inches.

If possible, position convex mirrors directly ahead of the intended user on the far side of the roadway, but it is best to experiment at other locations prior to permanently installing it. The angle formed between the observer, the mirror and the approaching vehicles should be 90 degrees or less. Typically, mount convex mirrors 10 to 15 feet above the roadway surface and brace it to reduce the chances of it becoming misaligned.

To determine the effectiveness of the mirror, have the stopped driver use the mirror and measure the elapsed time between the moment that a test car’s image becomes visible in the mirror and the moment the car reaches the intersection. Compare the elapsed times with the mirror at different locations and without the mirror. Always drive the test car at a constant speed for all comparisons.

Install the VEHICLES ARE CLOSER THAN THEY APPEAR (W14-11) sign beneath the convex mirror.

## 11.11 Highway Occupancy

### References

A Policy on Geometric Design of Highways and Streets, Fifth Edition, 2004, AASHTO. Also known as the “Green Book.”

Access to and Occupancy of Highway by Driveways and Local Roads ([67 Pa. Code, Chapter 441](#), Publication RR-441).

Design Manual, Part 2, PennDOT (Publication 13M).

Guidelines for the Design of Local Roads and Streets, PennDOT (Publication 70M).

Highway Occupancy Permit Handbook, PennDOT, (Publication 282).

Highway Occupancy Permit Manual. (Publication 170).

Roadway Construction Standards, PennDOT (Publication 72M).

Traffic Signal Design Handbook, PennDOT (Publication 149).

Traffic Signal Standards, PennDOT (Publication 148).

### District Traffic Engineering Unit Responsibilities

The major responsibilities of the District Traffic Engineering Unit in highway occupancy are limited to the following:

- Review and approve TCPs.
- Review all applications to install or replace crash-damaged utility poles or those to be located in areas on the utility pole, crash-cluster list or in limited-access right-of-way.



- Review and recommend approval or denial of access requests, as indicated below.
- Review and recommend approval of traffic impact studies.

The Permit Unit is responsible for conducting all field measurement of sight distance for driveway applications.

District Traffic Engineers should review the following access applications:

1. Applications for medium-volume and high-volume driveways. Low-volume and medium-use driveways need not be reviewed by the Traffic Engineering Unit except in special instances where the District Permit Office requests assistance in resolving a possible traffic flow or safety problem. If assistance is requested, complete cooperation should be extended to the District Permit Unit.
2. Applications involving requests for auxiliary lane(s).
3. Applications where measured sight distances as determined by the County Permit Supervisor is marginal (i.e., plus or minus 25 feet of formula sight distance).
4. Applications where traffic control devices will be added or modified (i.e., signalization, signage or pavement markings).
5. Applications where work zone traffic control reviews are required.
6. Applications where the applicant has a waiver under Department regulation [67 Pa. Code §441.5\(e\)](#) (relating to waiver of design requirements).

### Additional Review Guidelines

Unless indicated otherwise in [67 Pa. Code Chapter 441](#) or in Publication 170, design details and features on highway occupancy permit projects shall comply with the applicable provisions of:

- [A Policy on Geometric Design of Highways and Street.](#)
- [Design Manual, Part 2.](#)
- [Roadway Construction Standards.](#)
- [Guidelines for the Design of Local Roads and Streets.](#)
- [Traffic Signal Design Handbook.](#)
- [Traffic Signal Standards.](#)

Give particular attention to geometric modifications that modify the characteristics of through travel lanes and add new auxiliary turning lanes. It is important that the transitions (particularly for the through lanes), tapers, and storage requirements comply with the appropriate provisions in Design Manual, Part 2. In addition, design the proposed pavement structure for these lanes to be capable of withstanding the anticipated loads.

Pavement widening is often necessary to accommodate left-turn lanes. When this occurs, through travel lanes must transition from old to new pavement. The longitudinal joint created between old and new pavement crosses the through travel lane at an angle and can cause driver confusion, particularly at night. In order to eliminate this potential hazard, a full-width, thin overlay (normally 1.5" superpave) covering both new and old pavements is to be required at these sites. New pavement markings are also to be included.

Give emphasis to pedestrian and bicycle modes of transportation. Oftentimes, major developments are located in or on the fringe of major suburban areas and close to housing developments. Where these

situations occur, request developers to consider incorporating provisions in the site plan to enhance these modes of transportation. Typical enhancements include sidewalks, pedestrian phases at signals, and bicycle storage accommodations.

#### Preliminary Reviews

Districts shall honor all requests made by developers for preliminary reviews. This obviously does not mean that all permit applications have to undergo a preliminary review process; but it does mean that if a developer asks the Department to conduct a preliminary review, the Department will do so.

#### Concurrent Reviews

The Central Permit Office, the Bureau of Maintenance and Operations, and the Bureau of Design will review all highway occupancy permit application packages that come into Central Office concurrently (rather than consecutively). FHWA will still perform any necessary review after the Central Office review so that they will be aware of the Department's comments or concurrence when conducting their review. Similarly, involvement by the Office of Chief Counsel will usually have to come after design features and other matters have been approved by the other reviewing offices before related agreements can be finalized.

## 11.12 Municipal Waste Facilities

### General

The Department of Environmental Protection is responsible for the review and/or approval of all applications for the establishment of municipal and residual waste disposal facilities.

### References

*Highway Capacity Manual*, Transportation Research Board, "Special Report 209."

*Highway Occupancy Permits*, Commonwealth of Pennsylvania, [67 Pa. Code Chapter 441](#). Also available internally as Publication 441.

*"Municipal Waste Facilities Review Program,"* Executive Order No. 1996-5, dated August 29, 1996. (see <http://www.pacode.com/secure/data/004/chapter5/subchapKKKtoc.html>)

### District Involvement with DEP Reviews

The following is a brief summary of the role that the Engineering District Offices will play in the Pennsylvania Department of Environmental Protection's (DEP's) Municipal Waste Facilities Review Program as a result of the Governor's Executive Order Number 1996-5, "Municipal Waste Facilities Review Program" (dated August 29, 1996) and DEP's related policies for the local municipality involvement process, the environmental assessment process (Phase I review), the municipal waste facility review – traffic analysis, and the process for evaluating daily volume.

PennDOT's basic role in this program will be to serve as a reviewing agency for transportation-related studies (i.e., Transportation Impact Studies or TISs) involving State highways (SRs) that are submitted to DEP by an engineer for a municipal waste facility. PennDOT will forward comments and recommendations to DEP to assist them in making decisions regarding municipal waste facility permits. In addition, through its highway occupancy permit process ([67 Pa. Code Chapter 441](#)), PennDOT will need to review and approve plans and specifications for needed work within State highway right-of-way to accommodate waste facility traffic. These plans and specifications are to be developed by an engineer for the municipal waste facility, and the improvements will be implemented by the waste facility owner/operator in accordance with a

PennDOT-issued HOP. PennDOT will also assist DEP, as necessary, in its review of existing waste facility permits and associated operations.

Listed below in chronological order are the roles that the Engineering District Offices will undertake regarding applications for new municipal waste facilities, applications for expansions of existing facilities that would result in additional waste volumes or capacity, and periodic reviews of existing waste facility permits and operations. Unless indicated otherwise, “PennDOT” means PennDOT’s appropriate Engineering District Offices, and “DEP” means DEP’s appropriate Regional Offices.

#### New Facilities or Major Modifications of Existing Facilities

1. Since PennDOT will be a reviewing agency, DEP will invite PennDOT to attend the pre-application meeting with the host municipality prescribed in DEP’s local municipality involvement process, if one is held. PennDOT attendance at this meeting will be optional. DEP forwards meeting minutes, or a summary of the meeting, to PennDOT.
2. DEP forwards the applicant’s responses to Form D, Section I – Traffic, and other pertinent sections, to PennDOT (e.g., a copy of the past TIS if major modifications are proposed for an existing facility, such as an increase in waste capacity or an increase in maximum daily waste volume). PennDOT reviews this information, makes a preliminary determination concerning whether a TIS (or a new TIS if modifications are proposed) will be required, and advises DEP of this preliminary determination and other preliminary comments regarding the scope of the study and the study area.
3. After receipt of a permit application, DEP schedules a meeting with interested local municipal officials and the permit applicant, and invites PennDOT to attend. This second meeting is described in DEP’s policy for the local municipality involvement process. At the meeting, the applicant’s proposal is explained, DEP explains its review process, and local officials can express public concerns. If its schedule permits, PennDOT will attend this local municipality involvement meeting in order to listen to the public concerns and to answer general transportation-related questions (if necessary). If PennDOT cannot attend this meeting, and if requested by DEP, PennDOT can provide a letter to be shared at the meeting regarding its views and current position on the application. DEP forwards meeting minutes, or a summary of the meeting, to PennDOT so that it is cognizant of any transportation-related public concerns.
4. Taking input from the local municipality involvement meeting into consideration, PennDOT makes a recommendation concerning whether a TIS (or a new TIS if modifications are being made) should be required, and advises DEP accordingly.
5. If requested by the applicant, PennDOT attends a preliminary review meeting on the TIS as indicated in PennDOT’s Transportation Impact Study Guidelines for Municipal Waste Facilities. Issues pertaining to the required scope of the TIS are addressed.
6. In accordance with DEP’s local municipality involvement process, it is necessary to negotiate a permit application review timeline. PennDOT attendance at meetings on this matter will be optional, but PennDOT will be required to give DEP an estimate of its anticipated review time requirements.
7. When requested, PennDOT will provide the following information to the engineer performing the TIS for the municipal waste facility:
  - Information on future PennDOT improvement projects within the study area.
  - Any readily available traffic volume data for the applicable locations.

- Factors to use to project background traffic growth.
  - Reported traffic crash data for the study area as indicated in PennDOT's Transportation Impact Study Guidelines for Municipal Waste Facilities.
  - Any existing, readily available information that could be used in the approach route structural analyses.
8. PennDOT will review submissions and attend meetings related to the TIS, truck access route approval requests that may be needed in accordance with §4908 of the Vehicle Code (relating to the operation of certain combinations on interstate and certain other highways), and highway occupancy permit submissions for needed work within State highway right-of-way.

#### Periodic Review of Existing Facilities

1. DEP is required to review an existing municipal waste facility permit and associated operations at least every 5 years. When requested by DEP, PennDOT will provide comments (from a transportation system impact standpoint) to assist DEP in establishing a priority listing of sites for these reviews.
2. When DEP selects an existing facility for review, DEP will send PennDOT any previous TIS that was prepared for the site and any related information regarding any previous transportation-related concerns that have been received regarding the operation of the facility, and other pertinent information. PennDOT will determine if the facility has a highway occupancy permit, if there have been legitimate transportation-related public concerns, and if transportation-related problems appear to exist (or appear to have occurred) due to the operation of the facility. To assist in this determination, PennDOT may conduct pavement testing, may ask DEP to have the owner/operator of the municipal waste facility submit updated Form D information, and may suggest that DEP employ its local municipality involvement process or other form of public input.
3. Based upon a review of this information, PennDOT will advise DEP whether a new TIS should be required, and the issues that need to be addressed within the scope of the TIS.
4. From this point, PennDOT involvement is similar to that described above, beginning in Step 3 of "New Facilities or Major Modifications of Existing Facilities."

### **Transportation Impact Study (TIS) Guidelines**

#### **Purpose**

When preparing a transportation impact study (TIS) for a municipal waste facility, follow these guidelines, which outline the procedures and criteria.

The purpose of the TIS is to define the impact of the waste facility on the transportation system – both at the waste facility site and along the approach routes to the site. The TIS must address the issues contained in these guidelines, must address transportation-related public concerns, and ultimately must identify improvements and other actions that are necessary (at the waste facility site and along its approach routes) in order to safely and efficiently accommodate traffic to and from the municipal waste facility without adversely affecting the transportation system.

These guidelines were prepared pursuant to the Governor's Executive Order Number 1996-5, "Municipal Waste Facilities Review Program," dated August 29, 1996. They also correlate with the Department of Environmental Protection's (DEP's) policies for the local municipality involvement process, the

environmental assessment process (Phase I review), the municipal waste facility review – traffic analysis, and the process for evaluating daily volume.

### Applicability

These guidelines apply for TISs involving State Routes (SRs), i.e., State highways under the jurisdiction of PennDOT.

PennDOT does not have jurisdiction over local highways. However, in many cases, municipal officials may require the municipal waste facility owner/operator to conduct analyses of affected local highways in a manner consistent with these TIS guidelines.

### Reviewers

A TIS must be coordinated with, and reviewed by, the appropriate federal, State, and local officials.

Upon receipt of a TIS, DEP will distribute it for review by the appropriate parties and/or their designated entities (consultants). DEP will consider these reviewer comments when determining whether to approve or deny a permit application for a new municipal waste facility or an expansion of an existing municipal waste facility that would result in additional waste volumes or capacity. DEP will use this TIS information to determine if specific permit conditions need to be imposed and/or whether the permit issuance must be contingent upon the satisfactory completion of specific transportation system improvements.

When a TIS is prepared for an existing facility that is not requesting an expansion (i.e., not requesting an increase in waste capacity or an increase in maximum daily waste volume), DEP will consider reviewer comments in a similar fashion to determine if:

1. The exiting permit should be renewed, revoked or suspended.
2. A modified permit should be issued with specific conditions and/or the satisfactory completion of specific transportation system improvements.

A TIS must identify needed transportation system improvements to accommodate municipal waste facility traffic. Proposed improvements to State highways require PennDOT approval, and proposed improvements to local highways require the approval of local authorities. Moreover, FHWA must review and approve any work within the right-of-way of any interstate highway. When the recommended improvements will require a commitment from a municipality for continued maintenance and/or operation (such as with traffic signals), the TIS must include written evidence from the municipality indicating whether or not the municipality has agreed to accept these responsibilities.

### Other Transportation-Related Permits/Approvals

In accordance with [67 Pa. Code Chapter 441](#), PennDOT must provide a highway occupancy permit before constructing or altering a driveway, local road, or drainage facility/structure within State highway right-of-way.

Depending upon the length and width of combinations that will be traveling to and from a municipal waste facility, truck access route approval, in accordance with §4908 of the Vehicle Code (relating to the operation of certain combinations on interstate and certain other highways), may also need to be obtained from PennDOT and/or the local municipality.

Where applicable, the TIS submitted to DEP in accordance with these guidelines should contain the information necessary to satisfy PennDOT's HOP and truck access route requirements.

### Determining the Need for a TIS

DEP will advise the owner/operator of the municipal waste facility whenever a TIS will be required after considering input from PennDOT and other appropriate reviewers.

Make the determination in the following manner.

#### New Facilities

For applications involving new municipal waste facilities, the applicant's responses to DEP's Form D, Section I – Traffic, and other pertinent sections, will be forwarded by DEP to PennDOT and other appropriate reviewers. In addition, relevant input from the public arising from DEP's local municipality involvement process and other sources will be forwarded to the same reviewers.

Based upon the comments of the reviewers of this information, DEP will advise the applicant whether a TIS will be required.

It is anticipated that a TIS will be required in conjunction with all applications for new municipal waste facilities.

#### Major Modifications of Existing Facilities – Increase in Capacity or Maximum Daily Waste Volume

For applications involving the expansion of an existing municipal waste facility that would result in additional waste volumes or capacity, DEP will forward PennDOT and other appropriate reviewers any previous TIS that may have been prepared for the site. The applicant's responses to Section I – Traffic, and other pertinent sections, and relevant input from the public arising from DEP's local municipality involvement process and other sources, will also be forwarded to the reviewers.

Based upon the comments of the reviewers of this information, DEP will advise the applicant whether a new TIS will be required. This determination will be based upon:

1. Whether there are transportation-related public concerns regarding the operation of the existing facility or the expanded volume or capacity facility.
2. Whether the operation of the existing facility has resulted in adverse transportation system impacts.
3. Whether the reviewers believe the proposed expansion in waste volumes or capacity may generate, or contribute to, adverse transportation-related impacts, and other factors.

It is anticipated that a TIS will be required in conjunction with most applications, for the expansion of an existing municipal waste facility that would result in additional waste volumes or capacity.

#### Periodic Review of Existing Facilities

DEP is required to review an existing municipal waste facility permit and associated operations at least every 5 years.

When DEP selects an existing facility for review, DEP will send PennDOT and other appropriate reviewers any previous TIS that was prepared for the site and related information, information regarding any previous transportation-related concerns that may have been expressed regarding the operation of the facility, and other pertinent information.

In cooperation with the other reviewers, DEP will determine if the facility has a highway occupancy permit, if there have been any transportation-related concerns, and if transportation-related problems exist or have occurred due to the operation of the facility. DEP's local municipality involvement process and other local input, as appropriate, will be used to help make these determinations.

DEP may request the owner/operator of the municipal waste facility to submit updated Form D information.

Based upon a review of this information, DEP will advise the municipal waste facility whether a new TIS will be required.

It is anticipated that a new TIS will only be required if there are legitimate transportation-related public concerns or (transportation-related problems are identified by the review agencies.

### **Preparation of the TIS**

When it has been determined that a TIS is required, it shall be the responsibility of the municipal waste facility owner/operator to ensure that the study is conducted in accordance with these guidelines. The study shall be prepared under the supervision of a registered professional engineer who possesses a license issued by the Pennsylvania State Registration Board for Professional Engineers. The final study report must contain the seal of the supervising engineer.

Unless specifically indicated otherwise, the study engineer is responsible for the collection of all information and data required to support the study effort. At the request of the municipal waste facility owner/operator, DEP and PennDOT will make available any existing, readily available information and data which may assist in the study effort. When additional traffic counts are required for the study, the study engineer shall collect such data.

Conduct the TIS using currently accepted engineering practices and procedures. The use of computer programs to conduct the required analyses is acceptable if the programs reflect the most current provisions of the analysis procedures. Recommended geometric, traffic operational, and transportation system improvements must meet or exceed all applicable federal, State, and local minimum design and operational criteria.

### **Preliminary Review/Scoping Meeting**

Once it has been determined that a TIS is required, PennDOT will honor a request by the municipal waste facility owner/operator to have a scoping meeting to serve as a preliminary review of draft TIS materials and related criteria. Some of the items that may be appropriate to address in the scoping meeting and preliminary review stage include, but are not limited to, study area, scope of the study, intersections to be included in the level of service analysis, background traffic growth rate to be used, and the manner in which public concerns will be investigated/addressed.

This scoping meeting and preliminary review are done as a service to the waste facility owner, and are not considered to be binding upon PennDOT. The preliminary review will be limited to determining whether proper procedures will be used, and whether adequate documentation will be provided in accordance with the requirements of these guidelines. The intent of this preliminary procedural review is to provide the study preparer with guidance on the adequacy of the study in meeting the requirements of these guidelines. The adequacy or appropriateness of specific transportation system improvements will not necessarily be addressed in this preliminary phase, since they depend upon the results of the study.

### **TIS Components and Report Requirements**

Each TIS shall consist of the components described in the following subsections, which are necessary to measure the impact of the municipal waste facility on the transportation system.

These procedures and requirements are intended to provide a basic framework for the preparation of a municipal waste facility TIS. Additions or modifications to this framework may be made if such changes are

approved by DEP, PennDOT, and other appropriate reviewers having jurisdiction. The preliminary review phase is the appropriate time to clarify issues pertaining to the required scope of a TIS for a specific facility.

The TIS report must document the results of the TIS and the recommended improvements that are necessary (at the waste facility site and along its approach routes) in order to safely and efficiently accommodate traffic to and from the municipal waste facility without adversely affecting the transportation system. The report must be presented in a format and context which can be understood by both technical and non-technical parties. Schematic diagrams, figures, charts, and/or tables should be used in the report for the presentation of data and the results of the various analyses. All data sources and study methodologies (including computer programs) must be properly referenced and documented. Any modifications to the referenced procedures must be properly documented to enable a review of the appropriateness of the modification.

The information and findings for each of the following subject areas must be contained in a separate section of the TIS report. An executive summary should also be included. Background calculations, computer printout, and supporting data should be included in a separate technical appendix.

#### Study Area – Site Location and Approach Routes

Unless indicated otherwise for a particular study component or during the preliminary review phase, the study area for the TIS shall consist of all portions of public highway, between the municipal waste facility site and the nearest limited access highway that will be used as an “approach route” by traffic traveling to or from the waste facility site.

For approach routes where the nearest limited access highway is a substantial distance from the waste facility, consideration may be given to using the nearest “major” highway as the study area boundary for that approach route, provided that all review agencies concur in advance to this modification. In some areas of the Commonwealth, “major” highway may be defined as a “major through traffic route” as shown on the Pennsylvania Official Transportation Map.

In addition to the above, the study area for a municipal waste facility TIS must include any section of public highway where, in the opinion of the reviewing agencies, legitimate transportation-related public concerns have been expressed as a result of DEP’s local municipality involvement process or other local input.

The proper study area to be used for a specific municipal waste facility TIS needs to be clarified in the preliminary review stage.

#### Site Description and Location

The TIS report shall contain a description of the municipal waste facility to include the type of facility and its operation. The name and address of the municipal waste facility owner/operator, as well as the study engineer, shall also be included with the submission.

Other required report information is as follows:

1. A location map showing the municipal waste facility site.
2. A site plan showing the location, geometry, and design features of all existing or proposed driveways to the facility.
3. Other related descriptive information, as required, to be in conformance with PennDOT’s HOP requirements (as outlined in [67 Pa. Code Chapter 441](#) and [Publication 282](#)).

#### Approach Routes



The TIS report shall contain maps, schematic drawings, and/or figures showing all approach routes to the site. Each approach route shall be labeled with State Route (SR) number, street name, and/or township road number.

A description of the approach routes shall also be included in this section of the report. Indicate type of roadway, number of lanes, speed limit, existing traffic signal locations, and other related information.

#### Waste Facility Traffic Volumes

Through the use of figures, schematic drawings, charts, and/or tables, indicate the daily and hourly volumes of traffic destined to and from the municipal waste facility on each approach route. Waste facility traffic volumes for each segment of every approach route shall be presented by direction (to and from the site).

In addition to trips by waste vehicles, the report shall separately identify the number of trips made to and from the site by other vehicles for other purposes (such as passenger car trips to and from work by the facility's employees).

The report shall provide a breakdown of waste facility traffic volumes by type of vehicle using AASHTO design vehicle designations (e.g., P for passenger car, SU for single unit truck, WB-50 for large semitrailer combination, WB-62 for interstate semitrailer with a 48-foot trailer, WB-67 for interstate semitrailer with a 53-foot trailer, etc.).

If vehicles transporting hazardous materials will be traveling to or from the site, the report shall identify their approach routes and traffic volumes by placard category.

Identify both existing (if applicable) and projected traffic volumes traveling to and from the municipal waste facility. The report shall include the maximum projected traffic volumes that are anticipated to travel along the approach routes to and from the site within the next 10 years for existing sites, or 10 years from the opening of a new site.

#### Programmed Transportation Improvements by Others

The TIS report shall identify all transportation system improvements within the study area that are programmed for completion within the next 10 years by PennDOT, local municipalities, developers, their contractors, or others.

In the TIS report, discuss the timing and nature of these improvements by others relative to their impact on any improvements or other actions that may be required by the municipal waste facility owner/operator.

#### Land Use and Environmental Impacts

The TIS report shall contain a description of existing land use at the municipal waste facility site, existing land uses along the approach routes, and anticipated land uses at the site and along the approach routes over the next 10 years. For new facilities, the report shall indicate whether the site complies with existing zoning and land development ordinances, or whether a special exception, variance, or amendment will be required.

Identify land uses along the approach routes as residential, commercial, industrial, agricultural, or other appropriate descriptive category.

The report shall identify locations of schools, hospitals, nursing homes, and other sensitive buildings along approach routes. Also, identify locations where residences or other sensitive buildings are close to the roadway (e.g., 50-foot setback or less).

In addition, indicate the location of other sensitive areas (such as parks, playgrounds, recreation areas, forests, picnic areas, natural landmarks, wild areas, scenic rivers, wetlands, public water supplies, historic or cultural sites, etc.) along approach routes.

The report shall describe any existing or potential adverse impact on these sensitive areas that has resulted, or may result, from waste facility traffic, taking into account exhaust fumes, odors, noise, and other environmental factors. Address any public concerns regarding these issues.

Document any required measures that need to eliminate, mitigate, or minimize these existing or potential adverse impacts in the "Improvement Recommendations" section of the report.

#### Level of Service (LOS) Analysis

The TIS report shall include an analysis of existing and projected traffic flow conditions along the approach routes to the municipal waste facility. This analysis shall follow the procedures contained in the most recent edition of the Transportation Research Board's "Highway Capacity Manual," Special Report 209.

Complete analyses for the following six scenarios:

1. Existing approach route conditions without waste facility traffic.
2. Existing approach route conditions with waste facility traffic.
3. Future approach route conditions without waste facility traffic.
4. Future approach route conditions with waste facility traffic.
5. Future approach route conditions with waste facility traffic and needed improvements. (Complete these analyses for locations where roadway and/or traffic operational improvements will be needed to satisfy LOS criteria.)
6. Existing approach route conditions with waste facility traffic and needed improvements. (Complete these analyses for locations where roadway and/or traffic operational improvements will be needed to satisfy LOS criteria.)

Unless specified otherwise by the reviewing agencies, base all "future" traffic analyses on a design year 10 years in the future, and shall reflect any growth in background and waste facility traffic during this period.

For each of the six above scenarios, levels of service must be determined for the AM peak hour of the approach route, the PM peak hour of the approach route, and the peak hour of the waste facility traffic (if it differs from the normal AM or PM peak hour of the approach route). All LOS evaluations must consider not only the overall intersection LOS but also the LOS for each approach and movement.

Complete LOS analyses for the following locations within the study area:

1. All driveways and site access points to the municipal waste facility.
2. Intersections and sections of highway along the approach routes where the reviewing agencies suspect that waste facility traffic may cause (or has caused) a degradation in the LOS or other undesirable traffic operations.
3. Intersections or sections of highway along the approach routes that are presently operating at LOS E or LOS F, or are expected to operate at LOS E or LOS F in the future design year, with or without the waste facility traffic.

4. Intersections or sections of highway along the approach routes with public concerns (because of DEP's local municipality involvement process or other public input) about traffic flow, congestion, or other undesirable traffic operations.

Address specific intersections and locations to be included in the LOS analysis in the preliminary review phase.

In addition to the LOS analyses, the reviewing agencies may require the study engineer to complete other related engineering studies. For example, any new traffic signals that are proposed must be justified by a traffic signal warrant analysis in compliance with Publication 212 (i.e., [67 Pa. Code Chapter 212](#)). Queue length studies shall be completed, when required by the reviewing agencies, to evaluate needed lengths of turn lanes and whether there is the potential for a backup of traffic from controlled intersections that could impact other intersections, including access points to the waste facility. Complete gap studies when required by the reviewing agencies, to evaluate the need for signal control, turn prohibitions, or additional site access points.

The results of these LOS analyses and other engineering studies must be included in the TIS report. Whenever possible, include figures, schematic drawings, charts, and/or tables to clearly present the result. Also, include background calculations, computer printouts, and other supporting data in a technical appendix.

The following LOS criteria must be satisfied for locations within the study area:

1. The existing LOSs with the waste facility traffic must be no worse than the existing LOSs without the waste facility traffic.
2. The projected future LOSs with the waste facility traffic must be no worse than the projected future LOSs without the waste facility traffic.
3. For locations where either the existing or future design year LOS without the waste facility traffic is LOS F, needed improvements shall be identified which will provide estimated delay with the waste facility traffic that will be no worse than the delay for that time period without the waste facility traffic.
4. New intersections established to serve as driveways and site access points to a municipal waste facility shall be designed to operate at LOS C or better in the future design year where rural conditions exist and LOS D or better in the future design year where urban conditions exist.

Roadway and/or traffic operational improvements that are needed along the approach routes to satisfy the above LOS criteria shall be identified and included in the "Improvements Recommendations" section of the report. The TIS report shall contain the results of the LOS analyses indicated in Items 5 and 6 of the second paragraph of the "Level of Service (LOS) Analysis" in this subsection to document that these improvements will indeed satisfy the LOS criteria.

#### Crash Analysis

The TIS report shall contain a crash analysis of each approach route.

The study engineer shall obtain the following types of crash data from PennDOT's appropriate Engineering District Office(s):

1. The most recent 5 years of reported crash data for each approach route.
2. The "Homogeneous Report" (which provides a summary of the expected crash experience for particular types of roadway).

3. A printout listing approach route locations where there have been reported crashes involving refuse vehicles within the last 5 years.
4. A map (or maps) showing approach route locations on State highways where there have been reported crashes involving refuse vehicles within the last 5 years.

The study engineer shall analyze the crash data to determine if there are any existing high crash locations along the approach routes (in terms of the number of crashes, crash clusters, crash rates, severity, etc.). The crash history of large trucks and other vehicle types that will be traveling to and from the waste facility (or have been traveling to and from the waste facility) must be closely examined to determine if the waste facility traffic is expected to create or contribute (or has created or contributed) to a traffic safety problem.

Any public concerns about crash history, crash potential, and other safety issues along approach routes to the municipal waste facility (which have been expressed as a result of DEP's local municipality involvement process or other local input) shall be studied and compared to actual crash data.

If waste facility traffic is expected to create or contribute (or has created or contributed) to a traffic safety problem on a particular section of highway, that section of highway will not be permitted to serve as an approach route unless the safety problem is corrected to the satisfaction of the reviewing agencies. The "Improvement Recommendations" section of the report shall include the measures that need to be undertaken.

#### Approach Route Operational Assessment

Each approach route to a municipal waste facility must be reviewed by the study engineer to determine whether it is satisfactory to handle the volume and type of waste facility traffic without having safety or operational problems. Therefore, an operational assessment of each approach route must be made, and the results must be contained in the TIS report.

The operational assessment shall examine the suitability of each approach route for waste facility traffic taking into consideration the size, type, volume, and operating characteristics of such traffic.

There are numerous factors that need to be considered when determining the suitability of a particular section of highway to serve as a municipal waste facility approach route. Some of the questions that need to be addressed for each approach route include:

1. Is there a more suitable alternate route that could be used as an approach route?
2. Are there any weight limits or vertical clearance restrictions that would affect waste facility traffic?
3. Are there any one lane or narrow bridges?
4. Are lane widths sufficient?
5. Are intersection turning radii sufficient to allow turns to be made within the physical boundaries of the roadway pavement and without encroaching on opposing travel lanes?
6. Are there locations where horizontal alignment, lane width, or other factor would result in encroachment into sidewalk areas, opposing/adjacent travel lanes, or onto shoulder areas? Are there shoulder drop offs, or locations where waste facility traffic may contribute to accelerated shoulder deterioration?
7. Are there locations where shoulders or a roadside clear zone are not present and a combination of factors such as curvature, lane width, etc., would result in off-tracking or run-off-the-road concerns?

8. Are there any long, steep downgrades? Are there any hazardous grade speed limits, truck pull off areas, or truck escape ramps?
9. For two-lane roadway sections, are the frequency and length of passing sections sufficient to provide for safe and efficient travel with the waste facility traffic?
10. Are there substantial lengths of grade, without climbing lanes or passing, which would impede truck speed?
11. Are there locations, which may present underclearance problems?
12. Are there locations with inadequate sight distance?
13. Are there any locations where turning, acceleration, or deceleration lane lengths are inadequate?
14. Would the municipal waste facility traffic have any adverse impact on school bus traffic?
15. Are there any other safety-related considerations relative to waste facility traffic?

The TIS report shall address the above questions for each approach route, and also identify specific locations where such features or conditions exist. In addition, the report must address any public concerns that have been expressed regarding these matters (from DEP's local municipality involvement or other public input processes).

DEP, PennDOT, or other reviewing agencies may require a waste facility owner/operator to provide test runs along a particular approach route using the types of vehicle that will be traveling to and from the waste facility to more conclusively demonstrate whether such movements can be made safely. The test runs may be videotaped for further study or use at a public meeting, and also to provide future documentation of the operation of the specific type of vehicle over the route.

If waste facility traffic is expected to create or contribute (or has created or contributed) to a traffic safety or operational problem on a particular section of highway, that section of highway will not be permitted to serve as an approach route unless the safety or operational problem is corrected to the satisfaction of the reviewing agencies. In this determination, existing waste facility traffic operations will be considered (if applicable), as well as existing operations by other vehicles of like size and operating characteristics. The "Improvement Recommendations" section of the report shall include the measures that need to be undertaken to address these issues.

#### Approach Route Structural Analysis

The TIS report shall include the results of a review, inspection, and analysis of the bridges and roadway pavement along the approach routes to determine if municipal waste facility traffic is expected to create or contribute (or has created or contributed) to damage or destruction of the approach route highways and bridges. The report shall identify locations where rehabilitation or repair, or other actions (such as bonds or permits for excess maintenance), are necessary in order to accommodate municipal waste facility traffic. Address all public concerns regarding these issues.

The study engineer shall conduct engineering studies in accordance with [§212.117 of Publication 212](#) (relating to weight, size and load restrictions).

During the preliminary review stage, PennDOT and the other reviewing agencies will define the scope and methodology for the required approach route structural analysis, including any existing information that can be made available. If the reviewing agencies require the study engineer to conduct additional testing (such as pavement deflection testing using a falling weight deflectometer), the agencies will define the type of testing and analysis required, the locations to be tested, and improvement responsibilities.

An independent firm may be retained by the municipal waste facility owner/operator to conduct additional pavement testing and analysis. The specific firm and manner of testing must be approved in advance by PennDOT for test locations on State highways.

The TIS report shall identify highway and bridge locations along the approach routes that are structurally inadequate to accommodate projected waste facility traffic or are near the end of their useful service life. Such locations will not be permitted to serve as an approach route unless the structural problem is corrected to the satisfaction of the reviewing agencies. Methods of correction may include repair or rehabilitation by the municipal waste facility owner/operator. In some instances, bonds or permits for excess maintenance may be required in accordance with §4902 of the Vehicle Code (relating to restrictions on use of highways and bridges) and 67 Pa. Code Chapters [189](#), [191](#), and [193](#). The “Improvement Recommendations” section of the report shall include the measures that need to be undertaken to address these issues.

#### Public Concerns

All transportation-related public concerns that are expressed as a result of DEP’s local municipality involvement process or other public input sources shall be discussed in the TIS report.

The TIS report shall contain a separate section listing these concerns. The public concerns shall also be addressed in this separate section of the report, or via cross references to other appropriate sections of the report.

Measures or actions that need to be undertaken shall be included in the “Improvement Recommendations” section of the report.

#### Improvement Recommendations

The TIS report shall contain a separate section that lists the transportation improvements and other actions that will need to be implemented within the study area by the owner/operator of the municipal waste facility or others as a result of the land use and environmental impact review, the LOS analysis, the crash analysis, the approach route operational assessment, the approach route structural analysis, and public concerns.

Unless indicated otherwise by the reviewing agencies, the owner/operator of the municipal waste facility will be responsible for funding transportation system improvements that are needed to accommodate waste facility traffic.

Upon final approval of the TIS report by the reviewing agencies, the owner/operator of the municipal waste facility will be responsible for funding the development of plans and specifications for all required transportation improvements within the study area as well as their physical construction, unless indicated otherwise by the reviewing agencies.

Improvement plans and specifications will need to be reviewed and approved by the appropriate reviewing agencies as indicated in the “Reviewers” section of these guidelines. In accordance with [67 Pa. Code Chapter 441](#), the owner/operator of the municipal waste facility will need to obtain a highway occupancy permit from PennDOT prior to starting work within State highway right-of-way.

## 11.13 Snowmobile and All-Terrain Vehicle Roads

### References

1. [Vehicle Code](#) (75 Pa. C.S.) – §§7721, 7722, and 7723.

2. Snowmobile and All-Terrain Vehicle Registration and Operation (17 Pa. Code, Chapter 51), (see the Department of Environmental Resources regulations at <http://www.pacode.com/secure/data/017/chapter51/chap51toc.html>).

### Establishing Snowmobile and/or ATV Roads on State Highways

§7722 of the Vehicle Code (75 Pa.C.S. §7722, relating to the designation of snowmobile and ATV roads) allows the Department of Transportation on State highways and local authorities on any highway, road or street within its jurisdiction to:

- Designate any highway, road or street within its jurisdiction as a snowmobile road, an ATV road, or both.
- Determine whether such road shall be closed to vehicular traffic or whether snowmobiles and ATV's may share this designated road with vehicular traffic.

#### All-Terrain Vehicles (ATVs)

For safety reasons, Engineering Districts shall not designate any State highway as an ATV road, or authorize ATVs to operate along any State highway.

#### Snowmobiles

1. All requests for the designation of State highways as snowmobile roads must come from the local authorities and the request shall include a completed copy of the resolution shown in **Chapter 11 Appendix** page 58. The Engineering District shall maintain a copy of the completed resolution.
2. The following State highways shall not be designated as snowmobile roads:
  - Numbered traffic routes.
  - Any highways where the ADT is more than 200 vehicles.
3. Snowmobile roads should normally be limited to State highways that are not winter maintained. However, an Engineering District may establish a District policy to permit certain types of winter maintained highways to be designated as snowmobile roads.
4. Snowmobile roads shall not be established in such a manner that would deny access to adjacent properties such as homes, cabins, hunting camps and other properties used by the owners and/or occupants during the winter months.
5. Install signs or barricades in accordance with the Department of Environmental Resources Regulation, 17 Pa. Code, Chapter 51, Snowmobile and All-Terrain Vehicle Registration and Operation – see [17 Pa. Code §51.82](#) (relating to barricades for snowmobile or ATV roads) [17 Pa. Code §51.83](#) (relating to posting signs for snowmobile or ATV roads).

Snowmobile road designations shall remain in effect until PennDOT rescinds the designation, which would occur if requested to do so by the municipality or if the Engineering District determines that changes in conditions of the roadway, traffic or other factors indicate that the roadway no longer meets the criteria for designation as a snowmobile road.

## 11.14 Closing State Highways for Special Events

### References

Vehicle Code (75 Pa.C.S.)

- §3367 – Racing on highways, specifically subsection (c), entitled “permits for special activities.”
- §6109 – Specific powers of Department and local authorities, specifically paragraphs (a)(3) and (a)(14).

Official Traffic Control Devices (67 Pa. Code Chapter 212, specifically [67 Pa. Code §212.701](#)).

## Policy

[§212.701 of Publication 212](#) (relating to processions, assemblages and special activities) establishes minimum criteria for processions, assemblages and special activities for both local roadways and State highways. This section provides for the issuance of permits by the Department, and §212.701(b) identifies what information is required from the sponsors.

§212.701(b) stipulates that all requests must be received a minimum of 3 weeks prior to the date of an event, i.e., by the District Executive for conventional highways and expressways, and by the Secretary of the Department for freeways. However, the Department cannot allow these events to transpire without a fully executed permit, which means that the sponsors must provide the prescribed materials and the Department must concur that it meets the minimum criteria.

Therefore, since sponsors generally desire to advertise their event several months in advance, Engineering Districts are encouraged to contact sponsors of annual-type events and suggest that they submit their applications a minimum of 2 months prior to any proposed event.

## 11.15 Turnback of Traffic Restrictions

### General

PennDOT’s “Road Turnback” Program is addressed in Publication 310, *“Transfer of State Highway (Road Turnback) Program, Policies and Procedures Manual”* (see <ftp://ftp.dot.state.pa.us/public/PubsForms/Publications/PUB%20310.pdf>). As part of this “Road Turnback” Program, it is necessary to send all approvals and study files for traffic restrictions to a municipality that accepts ownership of the highway.

### Suggested Transmittal Letter

**Exhibit 11-9** provides a suggested letter that your District may wish to use when forwarding any type of traffic restriction approvals and study files to a municipality. While the letters are only suggested formats, the information contained in paragraphs two and three should be included as appropriate with any package of approvals that are sent to a municipality.

If there are current traffic restrictions that were established and posted prior to July 1, 1977, they were given “grandfather” status and do not require an engineering and traffic study. Therefore, if this “grandfather” status applies to any traffic restriction relative to the current turnback, it is important to note this in the letter.

In addition, if there is any special signing that is necessary for continuity, it is important to define the requirements in the letter. For example, if the turnback section is part of a numbered traffic route or BicyclePA route, it is essential that either the local authority commit to maintaining the signing or allow PennDOT to retain the right to enter the turnback section and maintain the signs.



## 11.16 Turn Lane Guidelines

### General

The following turn lane guidelines have been developed to determine the warrants for turn lanes and to identify desirable length. The guidelines apply to highway occupancy permit projects, traffic signal permit projects, and Department construction projects. The guidelines apply for any one-hour period during the typical analysis periods. Typical analysis periods for projects are those for the future design year, as specified.

### Traffic Engineering Software

In addition to the procedures outlined in this document, at the discretion of the Engineering District, an operational analysis may be conducted to determine whether turn lanes may be warranted and to identify associated storage lengths. The operational analysis shall be conducted utilizing traffic engineering software packages that are approved by the Department as prescribed in [12Traffic Engineering Software](#). The results of both procedures can then be compared, and the more conservative results may be used. For example, although the application of these turn lane guidelines may indicate a turn lane is not warranted, if the operational analysis identifies the need for a turn lane to achieve acceptable levels of service, then the incorporation of the turn lane into the design may be considered.

Additionally, in those cases involving closely spaced intersections and complex transportation systems when intersection function may be affected by adjacent locations, the operational analysis may yield more appropriate results based on site conditions and may be given more consideration than the results obtained from these guidelines.

Use the 95<sup>th</sup> percentile turn lane queue when estimating required storage length from traffic engineering software packages, unless directed otherwise.

### Truck Adjustment Factors

To adjust for truck traffic, the following formula shall be used to develop a truck adjustment factor to be applied to the hourly volume to obtain a passenger-car equivalent volume for the advancing, opposing, and left turning volumes for both warrants and design:

$$T = 1 + P_T (E_T - 1)$$

where

$E_T$  = passenger-car equivalent for trucks

$P_T$  = proportion of trucks in the traffic stream (expressed as a decimal fraction)

$T$  = truck adjustment factor

The value used for  $E_T$  shall be taken from the following table based on the terrain of the surrounding area:

**Exhibit 11-5 Truck Adjustment Factors**

Type of Terrain		
Level	Rolling	Mountainous
1.5	2.5	4.5

The hourly volume shall be multiplied by the truck adjustment factor (T), and the resulting passenger-car equivalent volume shall then be used in all subsequent calculations identified in these guidelines. The truck adjustment factors were taken from Reference 3 (see page 50).

**Turn Lane Warrants**

Use Figures 1 through 8 in the [Chapter 11 Appendix](#) page 60 to determine whether a left turn lane is warranted on two-lane and four-lane roadways at unsignalized and signalized intersections. Use Figures 9 through 12 in the [Chapter 11 Appendix](#) to determine whether a right turn lane is warranted on two-lane and four-lane roadways at unsignalized and signalized intersections. For unsignalized intersections, the warrants only apply to the free flow approach. For left turns, if the plotted point falls above the appropriate left turn percentage line (L), a left turn lane is considered warranted. Engineering District discretion should be used as to whether the actual left turn percentage should be rounded up or down to match one of the lines in the graph. A turn lane may be considered if the criteria is met for any one-hour period.

Figures 1 through 8 in the [Chapter 11 Appendix](#) were adapted from References 1, 2, 4, and 9. Figures 9 through 12 in the [Chapter 11 Appendix](#) were taken from Reference 5 (see page 50 for a list of references).

**Turn Lane Storage Length**

Use [Exhibit 11-6](#) through [Exhibit 11-8](#) to compute storage length for left and right turn lanes at unsignalized and signalized intersections. [Exhibit 11-6](#) to [Exhibit 11-8](#) were adapted from Reference 5. Minimum recommended storage length is 75 feet, and all results should be rounded the next highest 25-foot increment. Turn lane storage length does not include taper length.

Consider using dual left turn lanes at signalized intersections when the hourly left turn volume exceeds 300 vehicles per hour.

**Exhibit 11-6 Turn Lane Storage - Type of Traffic Control Condition (A, B or C)**

TYPE OF TRAFFIC CONTROL	SPEED (MPH)					
	25 – 35		40 – 45		50 - 60	
	TURN DEMAND VOLUME					
	HIGH	LOW*	HIGH	LOW*	HIGH	LOW*
<b>SIGNALIZED</b>	A	A	B or C**	B or C**	B or C**	B or C**
<b>UNSIGNALIZED</b>	A	A	C	B	B or C**	B

\* LOW is considered 10% or less of approach traffic volume

\*\* Whichever is greater

**Exhibit 11-7 Turn Lane Storage – For Speed and Condition**

CONDITION A	
SPEED (MPH)	STORAGE LENGTH
Any speed	Length from <a href="#">Exhibit 11-8</a>
CONDITION B	
SPEED (MPH)	STORAGE LENGTH
40	75'
45	125'
50	175'
55	235'
60	295'
CONDITION C	
SPEED (MPH)	STORAGE LENGTH
40	61' + Additional length from <a href="#">Exhibit 11-8</a>
45	75' + Additional length from <a href="#">Exhibit 11-8</a>
50	93' + Additional length from <a href="#">Exhibit 11-8</a>
55	114' + Additional length from <a href="#">Exhibit 11-8</a>
60	131' + Additional length from <a href="#">Exhibit 11-8</a>

**Exhibit 11-8 Turn Lane Storage Based on Average No. of Vehicles/Cycle**

Average no. of vehicles/cycle*	Length (feet)	Average no. of vehicles/cycle*	Length (feet)
1	75	17	600
2	100	18	625
3	150	19	650
4	175	20	675
5	200	21	725
6	250	22	750
7	275	23	775
8	325	24	800
9	350	25	825
10	375	30	975
11	400	35	1125
12	450	40	1250
13	475	45	1400
14	500	50	1550
15	525	55	1700
16	550	60	1850

\* Average no. of vehicles/cycle = design hour volume of turning lane/cycles per hour

If cycles per hour are unknown, assume:

Unsignalized or 2 phase – 60 cycles per hour

3 phase – 40 cycles per hour

4 phase or more – 30 cycles per hour

At signalized intersections, consider dual left turn lanes and operational analysis.

### Other Warranting Factors and Considerations

While the preceding sections present analytical procedures to determine whether turn lanes may be warranted, it must be recognized that there are other factors that may need to be considered. These factors may justify turn lanes at some locations where the numerical warrants are not satisfied.

Some of the factors, or combinations of factors, that may need to be considered and may justify turn lanes to preserve safe and efficient traffic flow include crash history; sight distance; deceleration requirements; the type and volume of turning traffic considering nearby land use; grades; locations on high-speed, multilane highways; 85<sup>th</sup> percentile and safe running speeds; and engineering judgment.

### Example Problem

#### Problem Statement

Determine whether an exclusive left turn lane is warranted and its desired storage length on a signalized approach of a rural arterial highway (speed = 50 mph, 20% trucks, rolling terrain). Intersection approach volumes consist of 100 left turning vehicles per hour and 680 through vehicles per hour. Opposing traffic volume is 500 vehicles per hour. The traffic signal has a 90-second cycle length.

#### Determine Whether a Left Turn Lane Is Warranted

First, convert the hourly volume to a passenger-car equivalent volume:

$$T = 1 + .2 (2.5 - 1) = 1.3$$

$$\text{Passenger-car equivalent volume (left)} = 1.3 (100) = 130 \text{ vehicles}$$

$$\text{Passenger-car equivalent volume (through)} = 1.3 (680) = 884 \text{ vehicles}$$

$$\text{Passenger-car equivalent volume (opposing)} = 1.3 (500) = 650 \text{ vehicles}$$

$$\text{Passenger-car equivalent volume (advancing)} = 130 + 884 = 1,014 \text{ vehicles.}$$

Next, identify the percentage of left turns contained in the advancing volume:

$$L = 130/1014 = 12.8\%.$$

Then, use the appropriate graph from Figures 1 through 8 in the [Chapter 11 Appendix](#) to determine if a left turn lane is warranted. Therefore, based on site conditions, **Figure 4** will be utilized to plot the traffic information as follows:

Figure 4. Warrant for left turn lanes on two-lane highways (50 mph speed, unsignalized and signalized intersections)  
(L = % Left Turns in Advancing Volume)

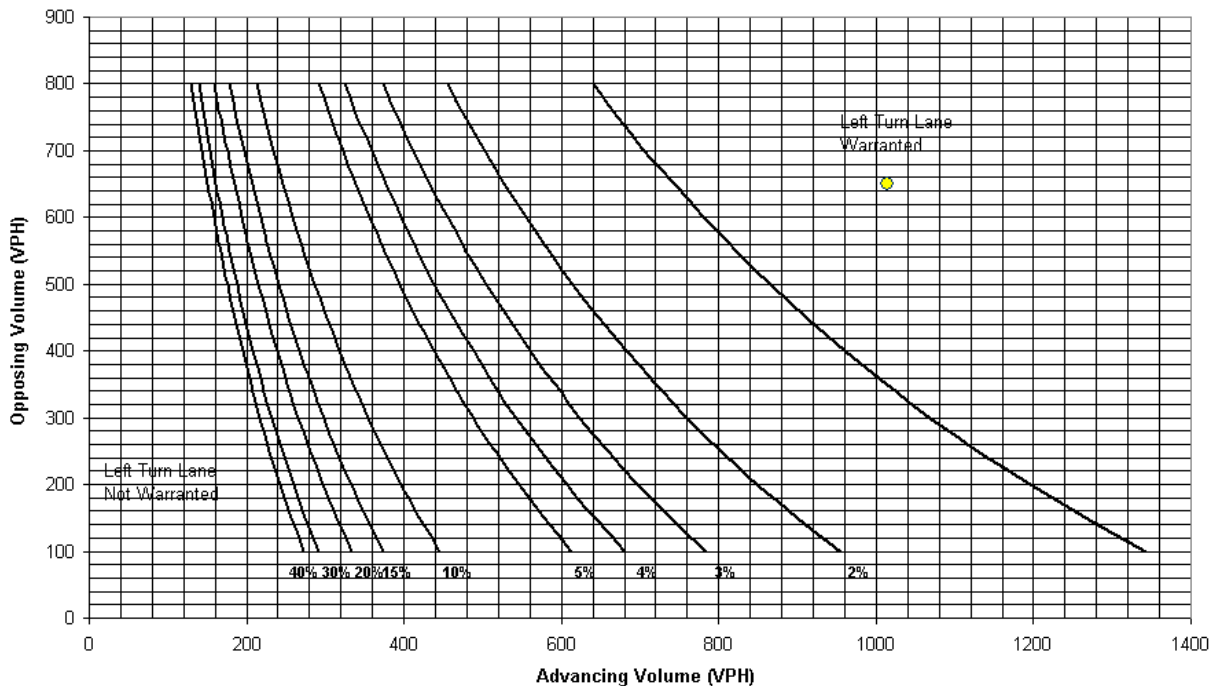

Since the plotted point falls above all of the left turn percentage lines, a left turn lane is warranted.

**Determine Storage Length**

Refer to [Exhibit 11-6](#). Using the given speed of 50 mph, enter the column with the speed “50-60”. Next, determine if the left turn demand volume is “high” or “low”. “Low” is considered 10% or less of the approach traffic flow. The demand is  $130 / (884 + 130) = 12.8\%$ . Therefore, the left turn demand is considered “high”. Based on a “signalized” intersection, the table indicates that Condition B or C (whichever is greater) should be used to calculate the storage length of the left turn lane.

Condition B, for the 50 mph speed from [Exhibit 11-7](#) gives a storage length of 175 feet.

Condition C is calculated by adding the 93 feet (for the 50 mph speed from [Exhibit 11-7](#)) to the additional length determined from [Exhibit 11-8](#). To determine the additional length, first calculate the number of cycles/hour ( $3600 \text{ seconds/hour} \div 90 \text{ seconds/cycle} = 40 \text{ cycles/hour}$ ). Next, divide the hourly left turn approach volume by the number of cycles per hour ( $130 \text{ left turning vehicles} \div 40 \text{ cycles/hour} = 3.25 = \text{round to } 3$ ). Using [Exhibit 11-8](#), the additional length is 150 feet. Adding the 150 feet to the 93 feet noted above equals 243 feet. A comparison of the values from Condition B and Condition C yields a storage length of 175 feet and 243 feet, respectively. Therefore, use the greater value of 243 feet. Rounding to the next highest 25-foot increment results in a recommended left turn storage length of 250 feet.

---

**References**

1. *Aspects of Traffic Control Devices, Volume Warrants for Left-Turn Storage Lanes at Unsignalized Grade Intersections*, M.D. Harmelink, Highway Research Record Number 211, Highway Research Board, National Research Council, National Academy of Sciences, Publication 1554, 1967.
2. *Guidelines for Left-Turn Lanes*, J.C. Oppenlander and J.C. Bianchi, 1990 ITE Compendium of Technical Papers, Pages 191 through 196.
3. *Highway Capacity Manual*, Transportation Research Board, National Research Council, 2000.
4. *Left-Turn Treatments at Intersections, NCHRP Synthesis 225*, Transportation Research Board, National Research Council, 1996.
5. *Location and Design Manual, Volume 1, Section 400, Intersection Design*, Ohio Department of Transportation, October 2004.
6. *Manual on Uniform Traffic Control Devices*, Federal Highway Administration, 2009 Edition.
7. *A Policy on Geometric Design of Highways and Streets, Fourth Edition*, American Association of State Highway and Transportation Officials, 2001.
8. *Design Manual Part 2 Highway Design, Publication 13M*, Pennsylvania Department of Transportation, July 2002.
9. *Engineering Study Guide for Evaluating Intersection Improvements, NCHRP Report No. 457*, Transportation Research Board, 2001.

**Exhibit 11-9 Sample Letter re the Turnback of Traffic Restrictions**

Turnback of SR \_\_\_\_\_  
by Act # \_\_\_\_\_

Dear \_\_\_\_\_:

Under the Department’s “Road Turnback” Program, the above State Route was placed under your jurisdiction on \_\_\_\_\_, 20\_\_ by Act \_\_\_\_\_, dated \_\_\_\_\_, 20\_\_\_. The responsibility for traffic restrictions on this road now rests with your municipality.

Enclosed for your information and files are the previously established traffic restriction approval(s) for this road by the Department of Transportation. We are also including the engineering and traffic studies that we made to justify the establishment of each of the traffic restriction. Please retain these studies for future reference or possible presentation at judicial proceedings that may result from enforcement of the restrictions.

The only official action that must be taken by your municipality to officially adopt the enclosed traffic regulations is covered under 75 Pa. C.S. §6109 of the Vehicle Code (relating to specific powers of department and local authorities). Specifically, subsection (b) of §6109 specifies that actions taken by local authorities shall be:

- (1) by ordinance of the local body: or
- (2) by a commission or public official authorized to act on specified matters.

If you have any questions or comments, please contact \_\_\_\_\_.

Sincerely,

District Executive  
District \_\_\_\_\_

**11.17 Chapter 11 Appendix**



---

**Study Elements that Suggest a Speed Limit Below 65 mph****Design Considerations\***

- Design speed less than 70 mph.
- Long sections where stopping sight distance is substandard, particularly on horizontal curves where sight distance is restricted by concrete median barrier.
- Numerous curves where the degree of curve or the superelevation is a problem for 70 mph.
- Grades where trucks typically travel at speeds of 50 mph or slower without a truck climbing lanes.
- Presence of bridges that are 200 feet or less in length and less than 34 feet wide, or are over 200 feet long and less than 31 feet wide.
- Short acceleration lanes that create substantial speed differentials, especially at locations where heavy traffic volumes or limited sight distance exist.
- Lane drop tapers that are less than 50:1.

**Maintenance**

- A road surface that encourages extensive speed differentials or may cause drivers to lose control at 65 mph.
- Skid numbers below 30.
- Frequent shoulder drop-offs of 2 inches or more, where drivers running onto the shoulder may be likely to lose control.
- Substandard size or condition of signs.

**Miscellaneous**

- Interchanges so close that excessive merging and diverging movements or excessive number of lane changes occur.
- An abnormally high crash or fatality rate.
- Engineering judgment suggests that physical characteristics would make the section unsafe for a 65-mph speed limit.

---

\* If as-built construction plans are available, they may provide some geometric features.

**Traffic Control Plan for Superloads and Non-Superloads on Freeways with Bridge Crawl Speeds**

Application ID#: \_\_\_\_\_

Bridge Structure ID#: \_\_\_\_\_

Motor Carrier Name: \_\_\_\_\_

Applicant's Signature: \_\_\_\_\_ Date: \_\_\_\_\_

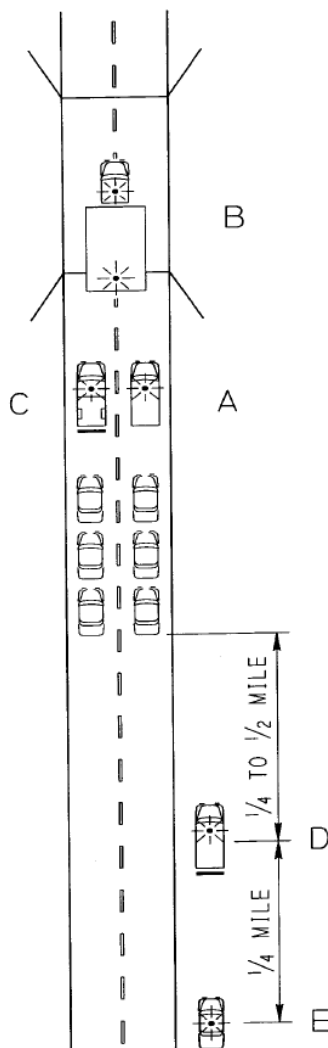

**A. PRIVATE ESCORT VEHICLE.** The hauler provides this vehicle, equipped with a flashing or revolving yellow light. The vehicle should normally be on the right side of the roadway in advance of Vehicle B. However, prior to reaching the bridge, this vehicle may allow Vehicle B to pass in order to run parallel with Vehicle C and form a rolling blockade.

**B. SUPERLOAD OR NON-SUPERLOAD.** This vehicle shall be equipped with two flashing or revolving yellow lights, one on the front and one on the back. The vehicle should maintain a minimum distance behind Vehicle A of 200 feet, or one bridge span length, whichever is greater.

**C. SHADOW VEHICLE.** The hauler provides this vehicle, equipped with a flashing or revolving yellow light and a truck-mounted variable message sign (VMS). The VMS shall flash the preprogrammed message "DO NOT PASS" when appropriate. The Department strongly recommends using a truck-mounted attenuator (TMA), if used, it shall be a type approved by the Department as meeting NCHRP Level 3 requirements. When on the bridge, the shadow vehicle should maintain a minimum distance behind Vehicle B of 200 feet, or one bridge span length, whichever is greater.

**D. QUEUE-MONITORING VEHICLE.** The hauler provides this vehicle and positions it on the shoulder whenever possible. It shall be equipped with a flashing or revolving yellow light and a variable message sign (VMS) alternately displaying preprogrammed messages "PREPARE TO STOP" and "SLOW DOWN."

**E. STATE POLICE.** This vehicle is only required for superloads. When used, the vehicle shall be a marked vehicle with revolving or flashing lights. Whenever possible, the vehicle should be positioned on the shoulder.

**NOTES:**

1. VMSs shall be of a type approved by the Department and listed in Bulletin 15. The VMS on Vehicles C and D shall be capable of displaying a minimum of two lines of message with minimum 14-inch legend.

2. The hauler shall provide CB radios in all vehicles for communication, including one for Vehicle E. One of the operators shall also have a cellular telephone for emergency purposes.
3. When operating between locations with crawl speeds, all vehicles should normally be in the right lane. The VMSs should display messages such as "OVERSIZE LOAD" and "PASS WITH CARE."

**Traffic Control Plan for Superloads and Non-Superloads on Two-Lane, Two-Way Roadways with Bridge Crawl Speeds**

Application ID#: \_\_\_\_\_

Bridge Structure ID#: \_\_\_\_\_

Motor Carrier Name: \_\_\_\_\_

Applicant's Signature: \_\_\_\_\_ Date: \_\_\_\_\_

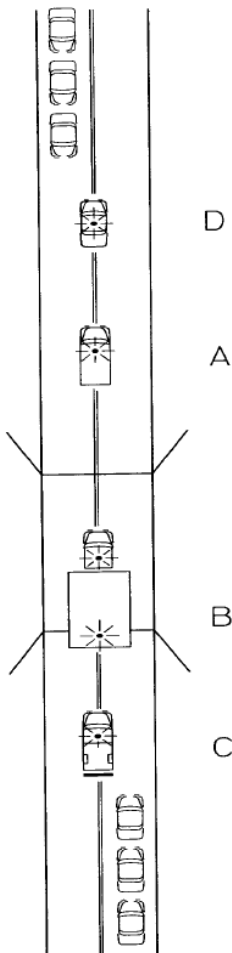

- A. PRIVATE ESCORT VEHICLE.** The hauler provides this vehicle, equipped with a flashing or revolving yellow light. When Vehicle D is not used, this vehicle shall be used to stop the approaching traffic at a distance of at least 350 feet before the bridge, and then release the approaching traffic only after Vehicle B has cleared the bridge and is in the normal travel lane. In order to stop traffic, it may be necessary to have someone use a red flag.
- B. SUPERLOAD OR NON-SUPERLOAD.** This vehicle shall be equipped with two flashing or revolving yellow lights, one on the front and one on the back. This vehicle should be positioned in either the center or the right side of the roadway in accordance with the permit. When Vehicle D is used, this vehicle should maintain a minimum distance behind Vehicle A of 200 feet, or one bridge span length, whichever is greater.
- C. SHADOW VEHICLE.** The hauler provides this vehicle, equipped with a flashing or revolving yellow light and a sign with the message "DO NOT PASS." The sign may be either a variable message sign (VMS) or a static sign. If a VMS is used, it should flash the message, when applicable. If a static sign is used, the sign shall be removed when it is not applicable. This vehicle should be positioned either in the center or on the right side of the roadway similar to Vehicle B. When on the bridge, the vehicle should maintain a minimum distance behind Vehicle B of 200 feet, or one bridge span length, whichever is greater.
- D. POLICE VEHICLE.** This vehicle is only required for superloads. When used, the vehicle shall be a marked vehicle with activated revolving or flashing lights. The trooper in this vehicle should stop approaching traffic at a distance of at least 350 feet before the bridge. The trooper should release the approaching traffic only after Vehicle B has cleared the bridge and is in the normal travel lane.

**NOTES:**

1. If a VMS is used, it shall be of a type approved by the Department and listed in Publication 35, and it shall be capable of displaying two lines

of message with minimum 14-inch legend. If a static sign is used, it shall use minimum 12-inch, black legend on a fluorescent yellow retroreflective sheeting material.

2. The hauler shall provide CB radios in all vehicles for communication, including one for Vehicle D. One of the operators shall also have a cellular telephone for emergency purposes.

Resolution Requesting the Designation of a Snowmobile Road

Resolution of

\_\_\_\_\_, \_\_\_\_\_ County,
(municipality)

The undersigned officials of the above municipality request the Pennsylvania Department of Transportation to designate the following State highway(s) as a snowmobile road(s):

Table with 5 columns: State Route, From / Offset, Segment, To Segment / Offset, Exclusive Snowmobile Use or Joint Use.

On the basis of their knowledge of the area, the undersigned officials certify that the highway(s) listed above can safely be used as a snowmobile road(s), and agree that the municipality will provide, install and maintain all necessary signs and barricades in accordance with the standards prescribed in Department of Environmental Resources Regulations, 17 Pa. Code, Chapter 51, "Snowmobile and All-Terrain Vehicle Registration and Operation" (see http://www.pacode.com/secure/data/017/chapter51/chap51toc.html). It is understood that snowmobile roads will be discontinued and all traffic control devices pertaining to snowmobiles will be removed if changes in conditions of the roadway, traffic or other factors indicate that the roadway no longer meets the criteria for designation as a snowmobile road.

BY: \_\_\_\_\_ (Title)
\_\_\_\_\_ (Title)
\_\_\_\_\_ (Title)

I certify the foregoing to be a true and correct copy of the Resolution of

\_\_\_\_\_, \_\_\_\_\_ County,

adopted at a duly convened meeting on \_\_\_\_\_.

\_\_\_\_\_

\_\_\_\_\_  
(Title)

(SEAL)

The above highway(s) is (are) hereby designated as a Snowmobile Road(s) in accordance with the terms and conditions expressed in the foregoing Resolution.

Date \_\_\_\_\_ By: \_\_\_\_\_

(District Executive)

Engineering District \_\_\_\_\_

For: \_\_\_\_\_

(Secretary of Transportation)

Turn Lane Warrant Figures

Figure 1. Warrant for left turn lanes on two-lane roadways (speeds to 35 mph, unsignalized and signalized intersections)  
(L = % Left Turns in Advancing Volume)

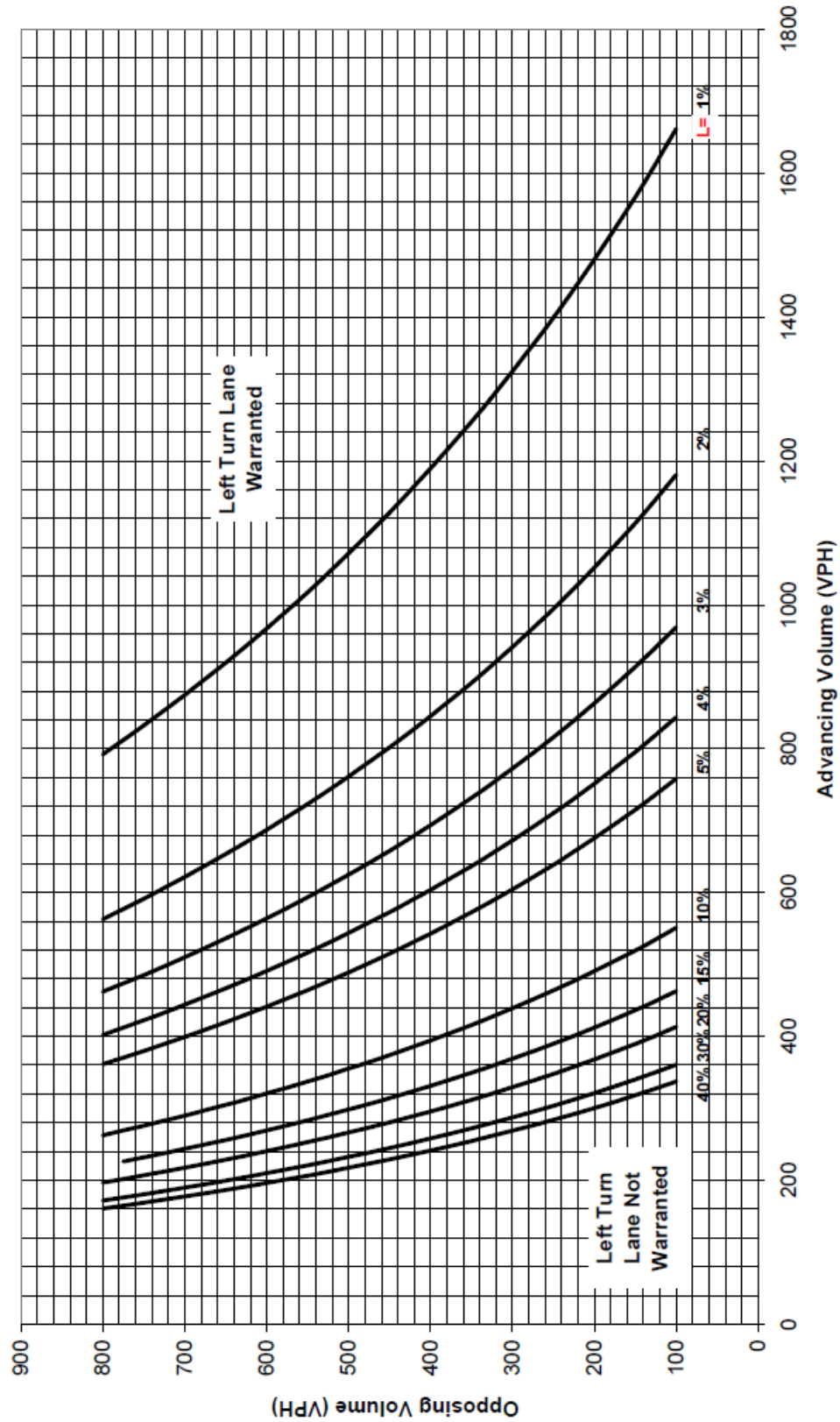



Figure 2. Warrant for left turn lanes on two-lane highways (40 mph speed, unsignalized and signalized intersections)  
(L = % Left Turns in Advancing Volume)

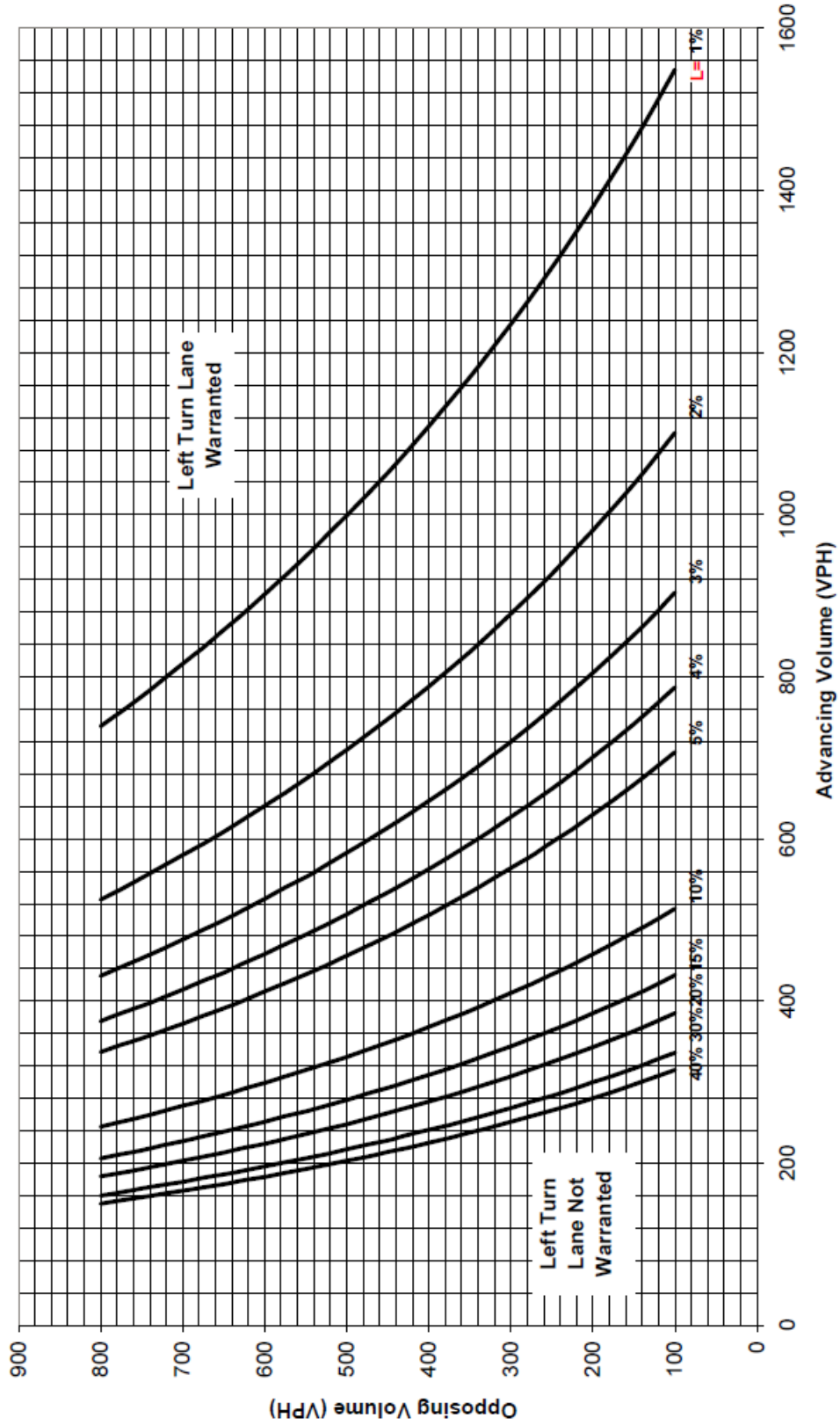

Figure 3. Warrant for left turn lanes on two-lane highways (45 mph speed, unsignalized and signalized intersections)  
 (L = % Left Turns in Advancing Volume)

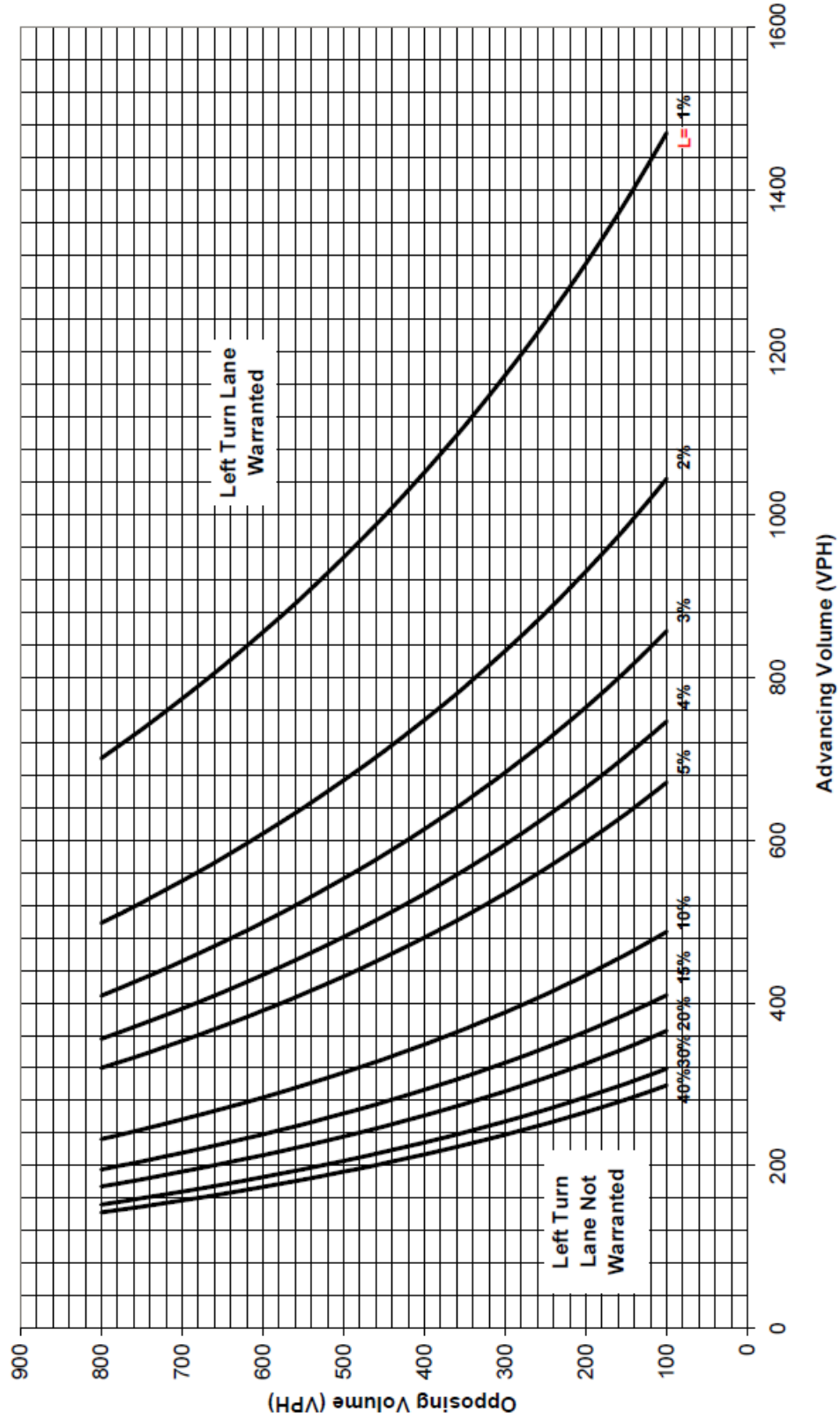

Figure 4. Warrant for left turn lanes on two-lane highways (50 mph speed, unsignalized and signalized intersections)  
 (L = % Left Turns in Advancing Volume)

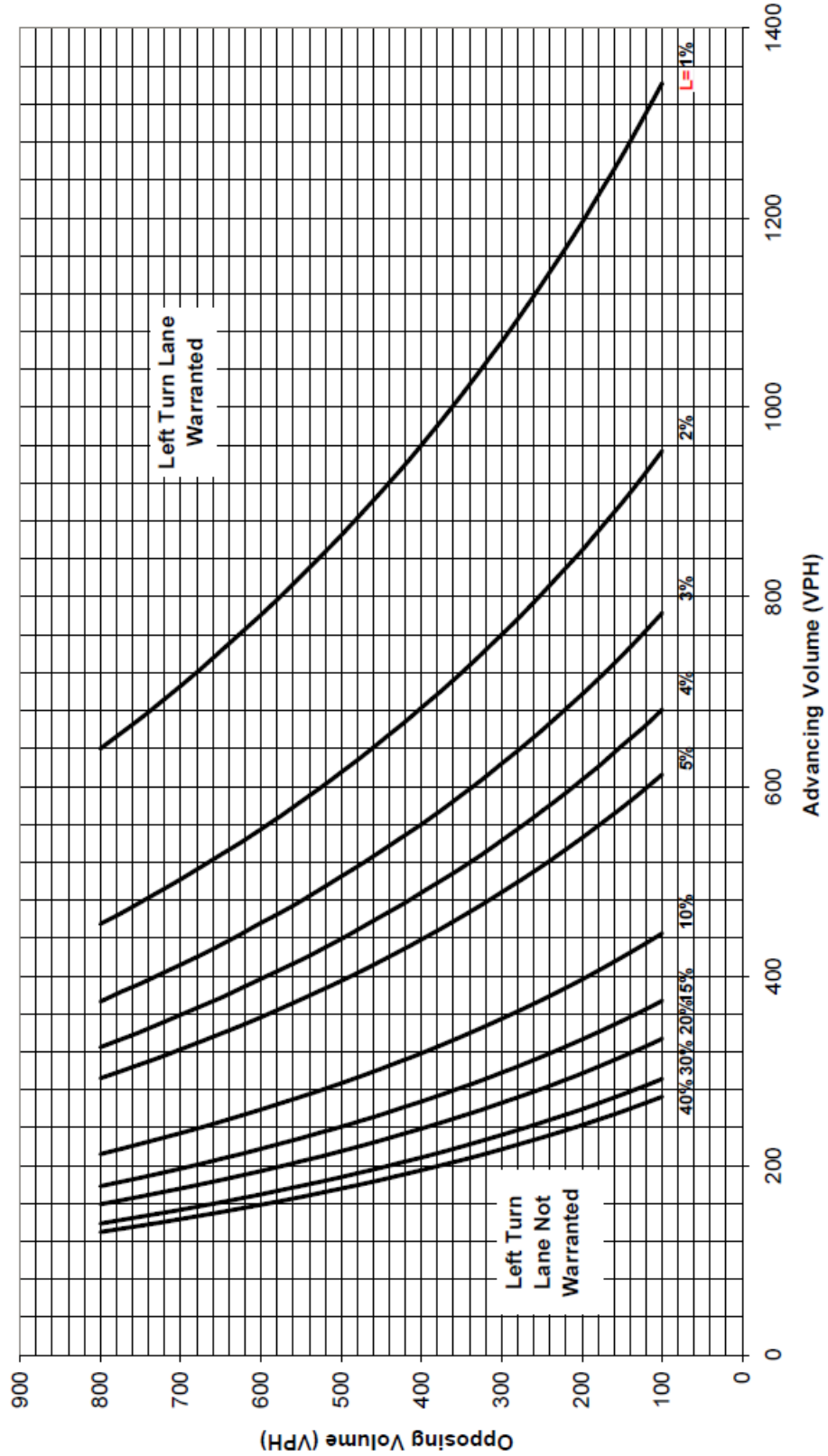

Figure 5. Warrant for left turn lanes on two-lane highways (55 mph speed, unsignalized and signalized intersections)  
(L = % Left Turns in Advancing Volume)

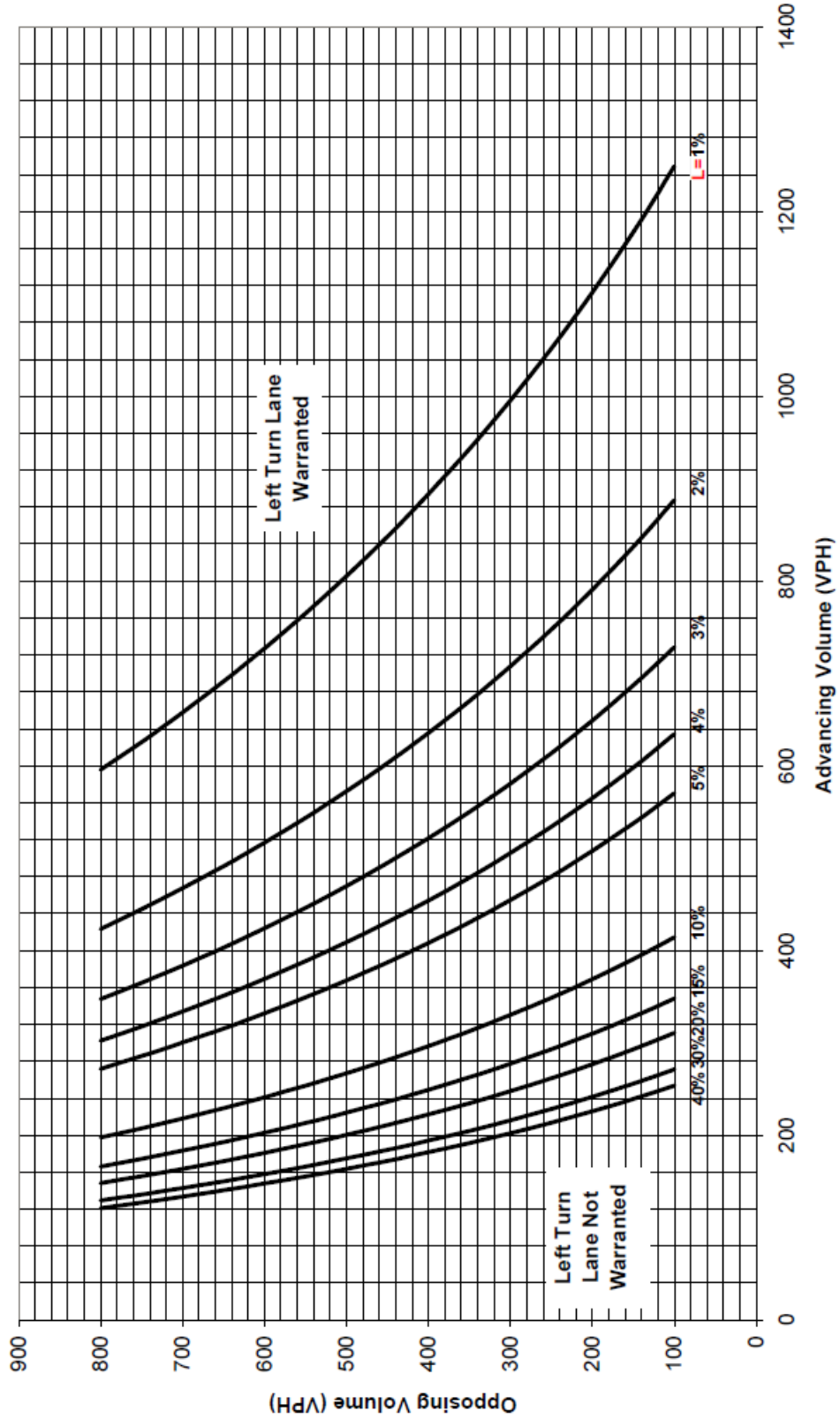

Figure 6. Warrant for left turn lanes on two-lane highways (60 mph speed, unsignalized and signalized intersections)  
(L = % Left Turns in Advancing Volume)

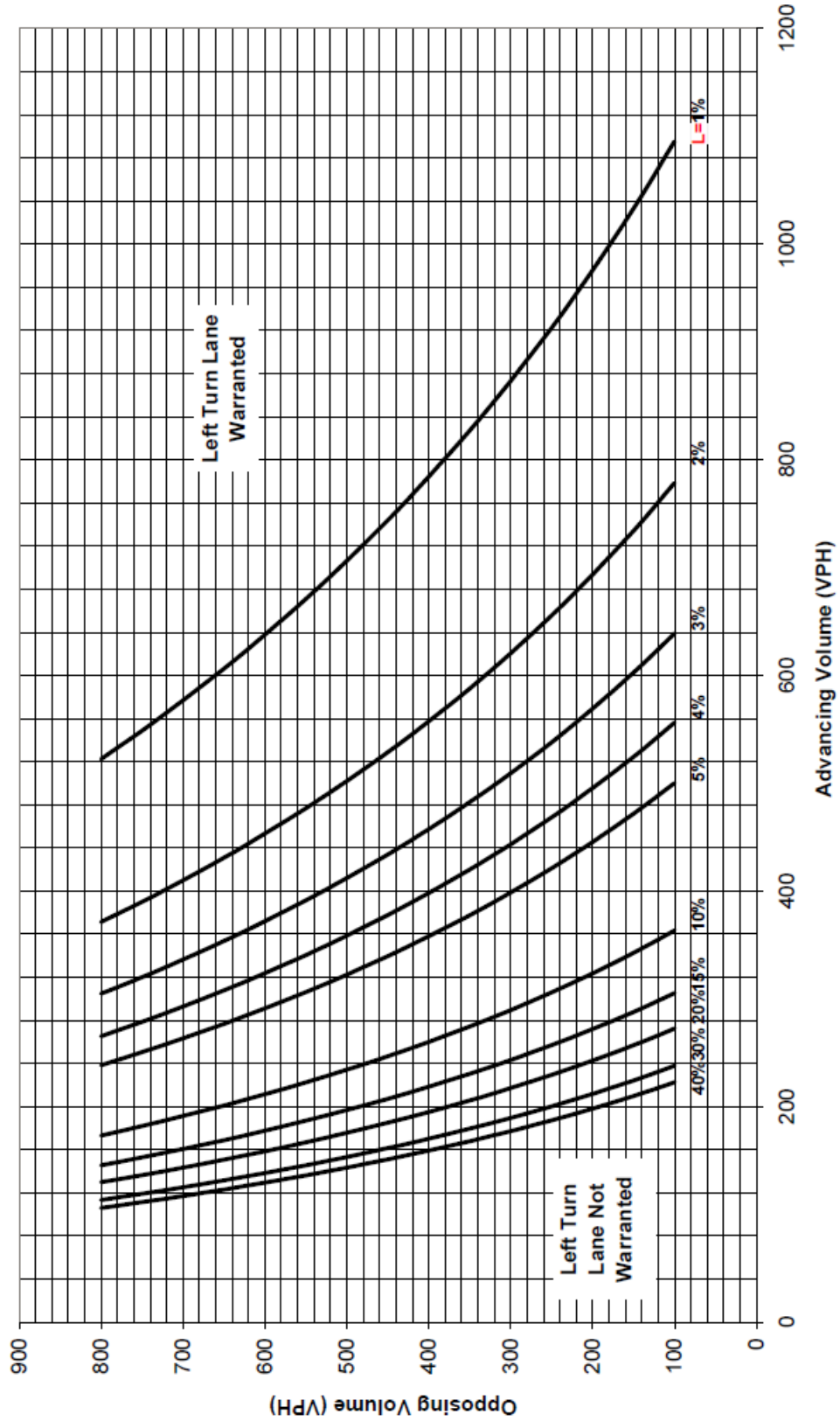

Figure 7. Warrant for left turn lanes on four-lane, undivided highways (unsignalized and signalized intersections)  
 (L = % Left Turns in Advancing Volume)

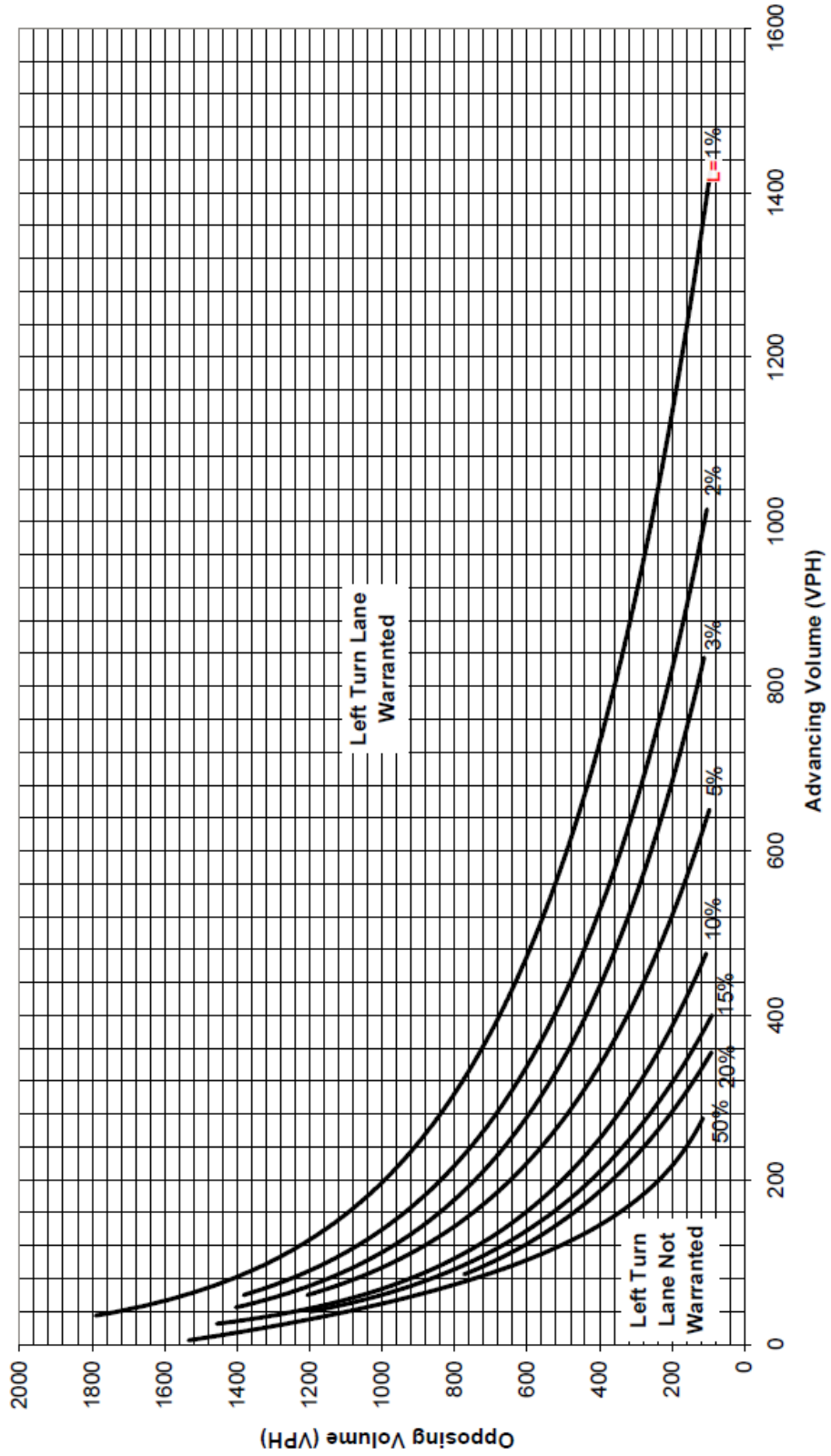

Figure 8. Warrant for left turn lanes on four-lane, divided highways (unsignalized and signalized intersections)

(L = % Left Turns in Advancing Volume)

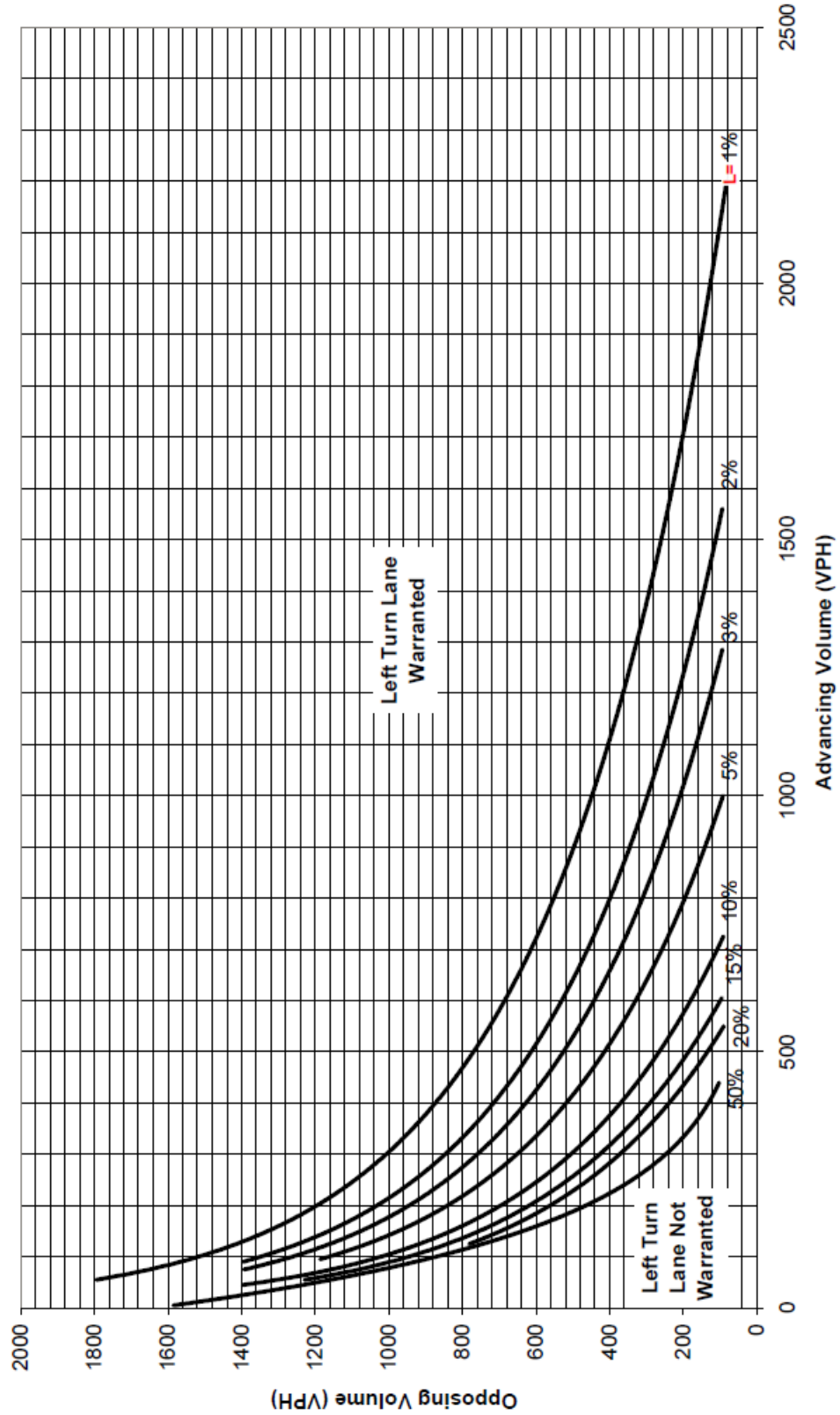

Figure 9. Warrant for right turn lanes on two-lane roadways (40 mph or lower speeds, unsignalized and signalized intersections)

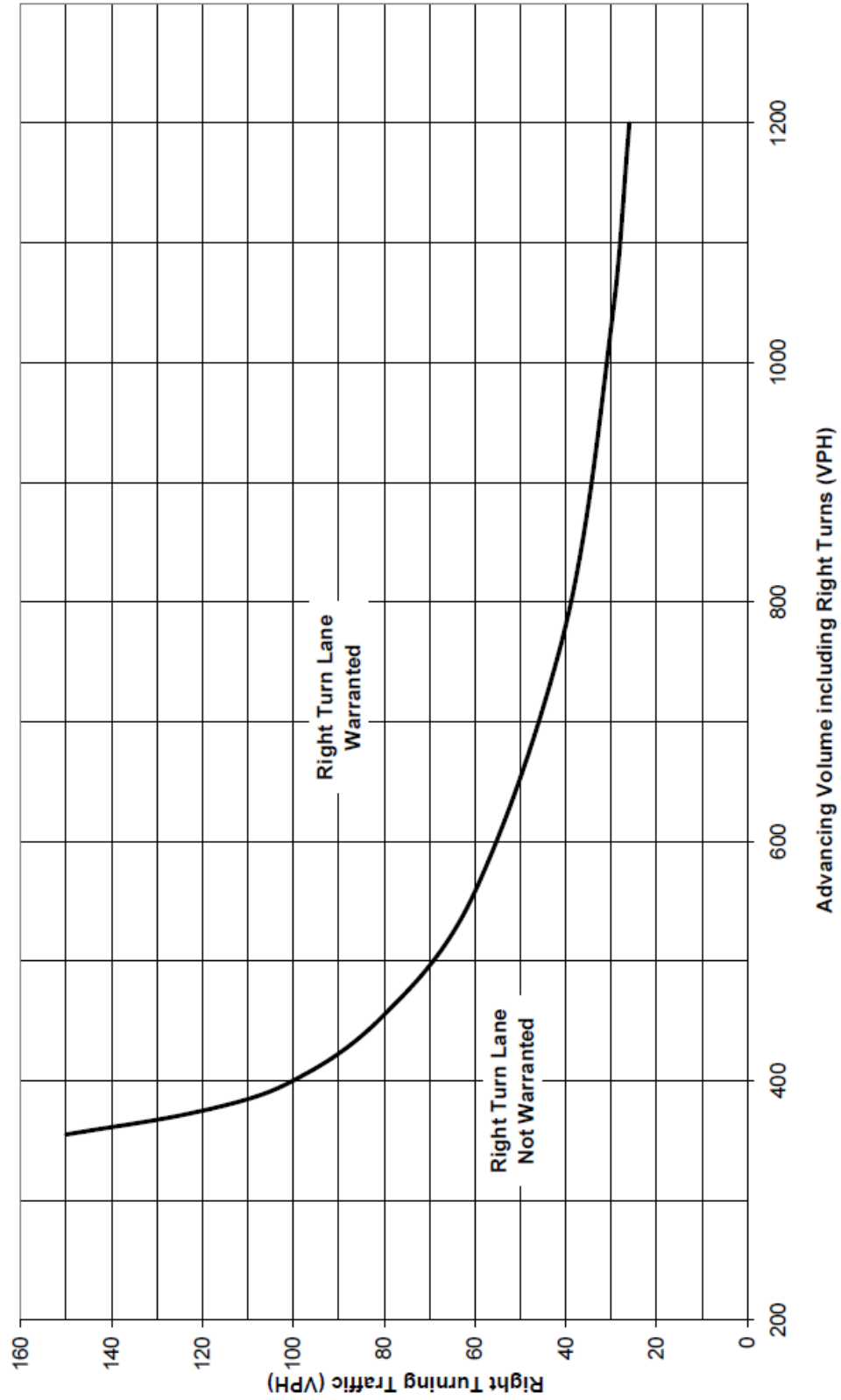



Figure 10. Warrant for right turn lanes on two-lane roadways (45 mph or greater speeds, unsignalized and signalized intersections)

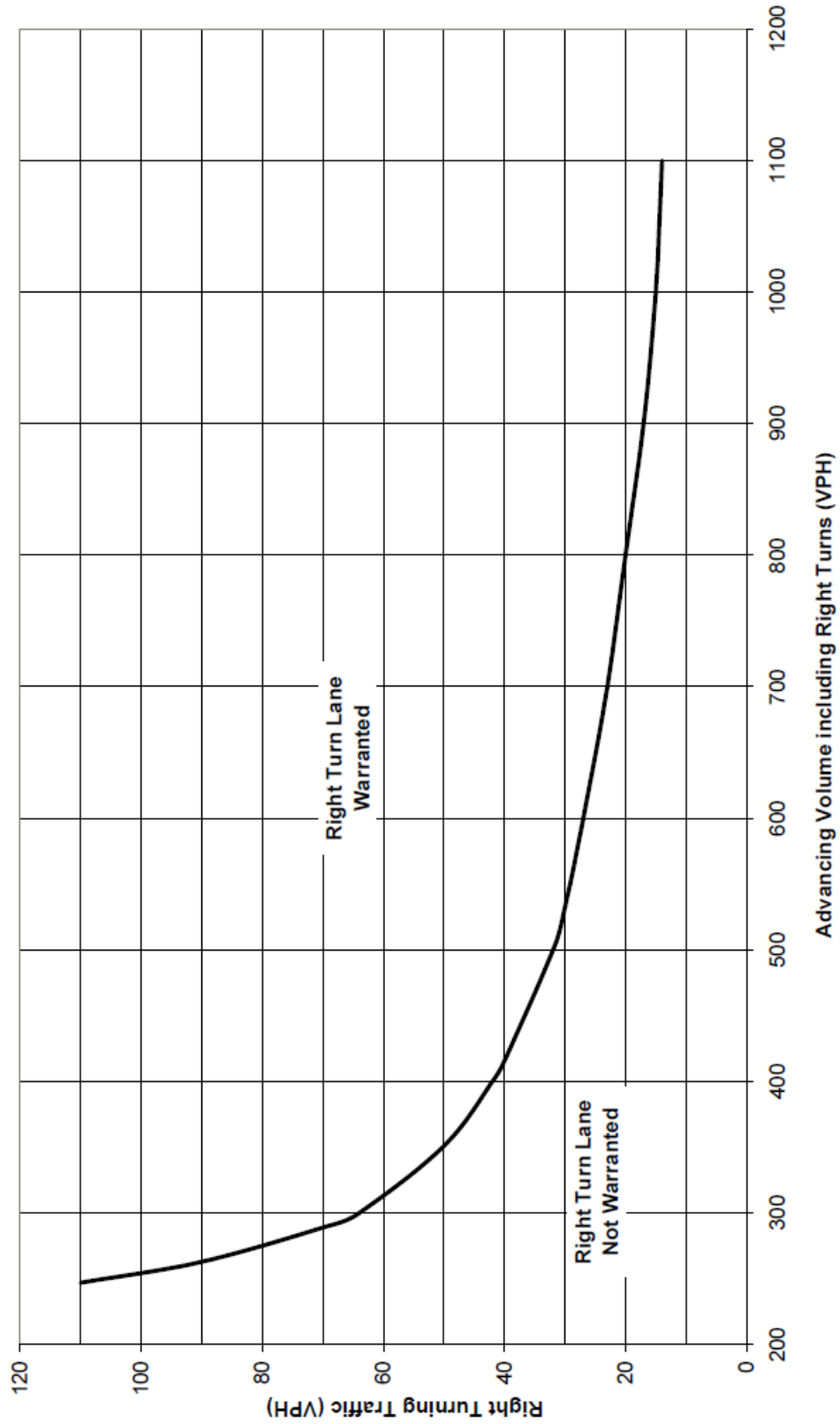

Figure 11. Warrant for right turn lanes on four-lane roadways (40 mph or lower speeds, unsignalized and signalized intersections)

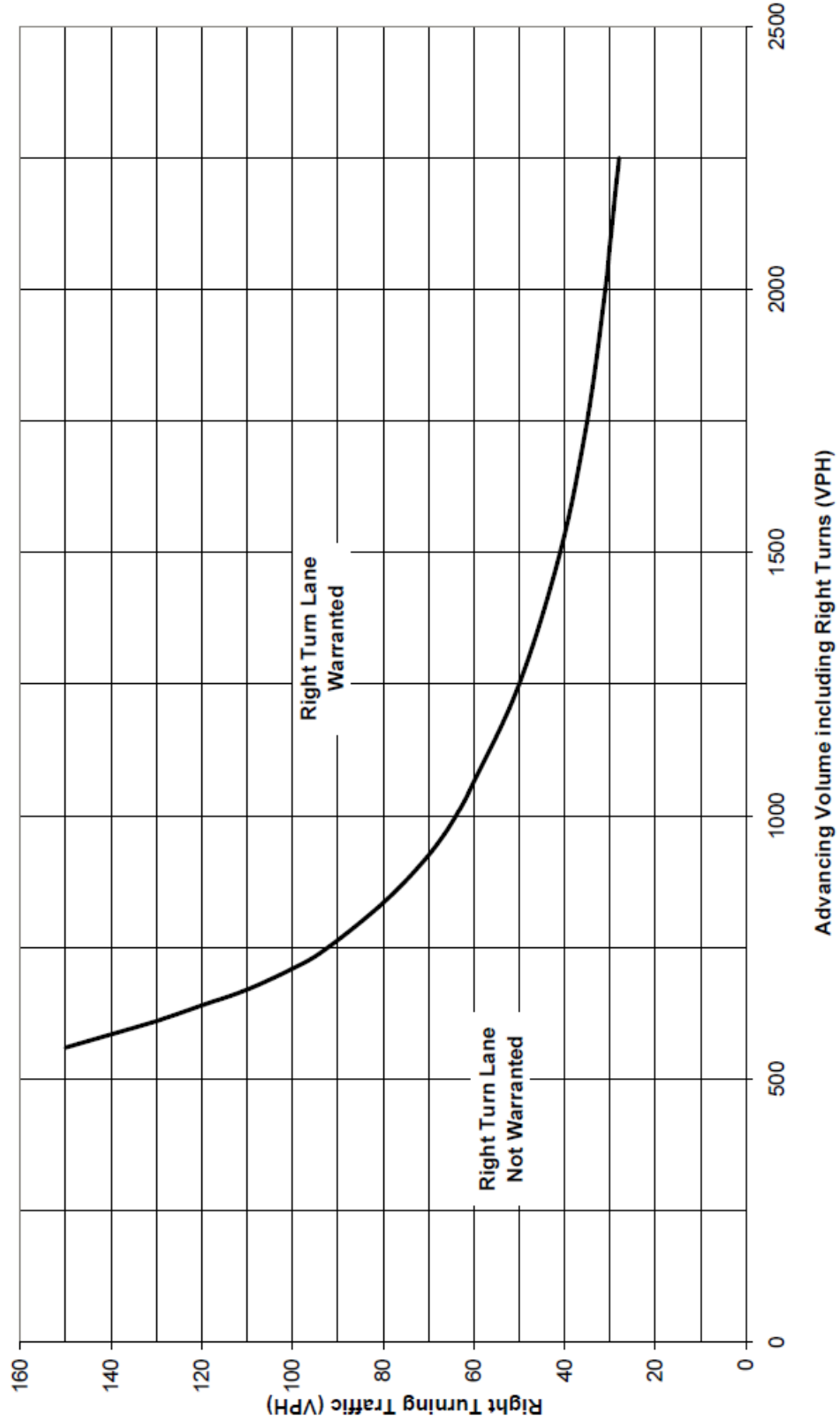
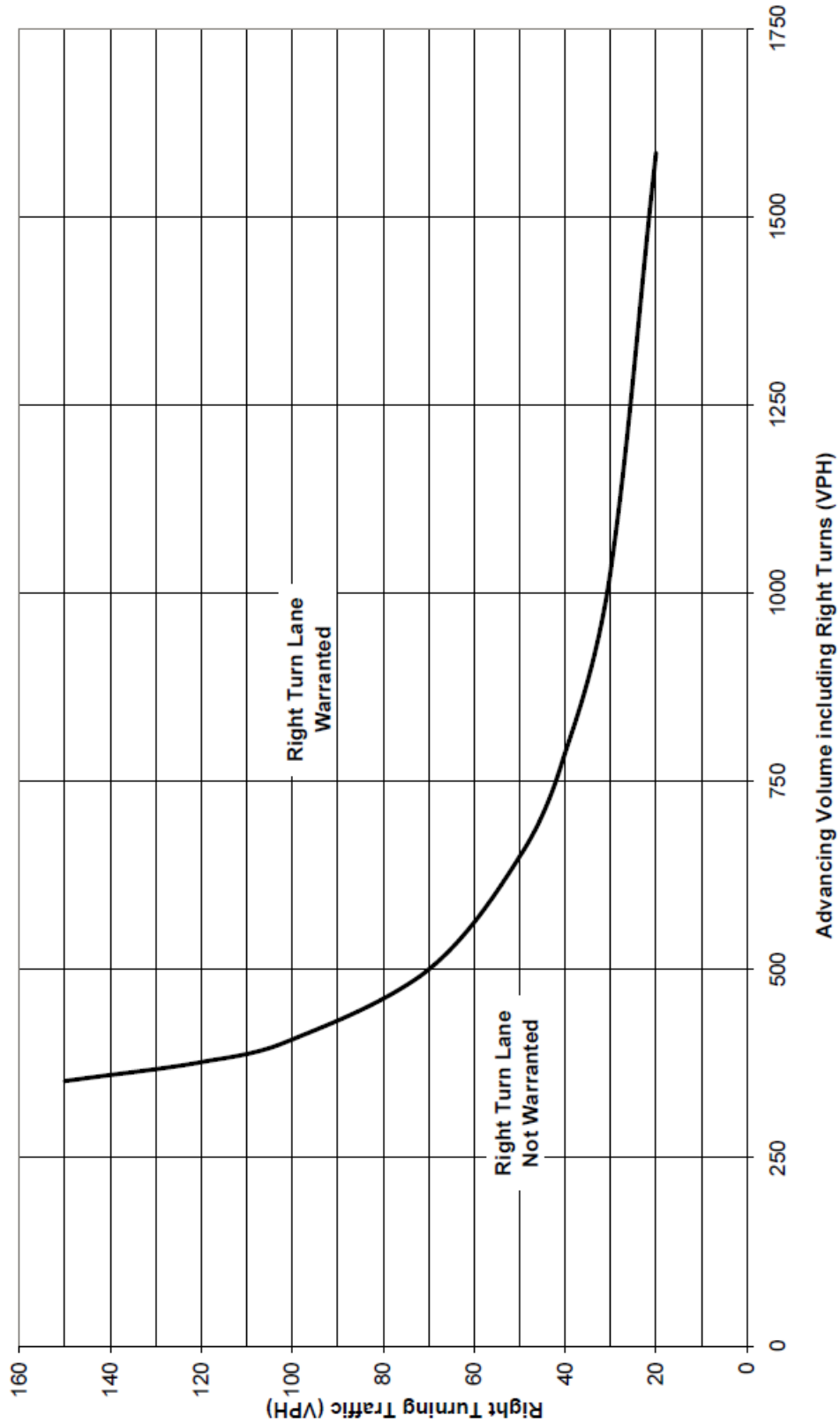

Figure 12. Warrant for right turn lanes on four-lane roadways (45 mph or greater speeds, unsignalized and signalized intersections)



## 12. TRAFFIC ENGINEERING SOFTWARE

### 12.1 General

#### Purpose

Various software packages are available for use by traffic engineers. Traffic analysis software packages are used to optimize traffic flows and capacity, or to simulate traffic flow. In general, the definition of simulation is the *“dynamic representation of some part of the real world achieved by building a computer model and moving it through time.”*

The purpose of this chapter is to summarize the Department’s position on the use of traffic engineering software.

#### Traffic Resources, Education, and Computing Support (TRECS) Group

The Department established the Traffic Resources, Education, and Computing Support (TRECS) Group to address computer hardware, software, and training issues as they pertain to the District Traffic Units and the Bureau of Maintenance and Operations (BOMO). In addition, the TRECS Group procures needed traffic engineering reference materials. The TRECS Group is comprised of representatives of every District Traffic Unit and BOMO. The Group meets on a regular basis, and it has dedicated funding within BOMO’s budget to fulfill its responsibilities.

One of the TRECS Group’s objectives is the review and evaluation of traffic engineering software packages to determine which software will be used and supported by the Department. Supported software means that the Department will continually purchase software upgrades for use by the Engineering Districts and Central Office, and that training has been, and will continue to be provided for appropriate Department personnel.

### 12.2 Specific Software

#### Supported Software

The Department supports the following traffic analysis tools, methods, and commercial software packages, which are organized according to traffic analysis tool category:

<u>Tools / Software</u>	<u>Traffic Tool Category</u>
HCM2010 Generalized Service Volume Tables	<ul style="list-style-type: none"> <li>• Sketch-Planning Tool</li> </ul>
ICU (Intersection Capacity Utilization)	<ul style="list-style-type: none"> <li>• Sketch-Planning Tool</li> </ul>
QuickZone	<ul style="list-style-type: none"> <li>• Sketch-Planning Tool</li> </ul>
PennDOT Delay Analysis Workbook (DAWB)	<ul style="list-style-type: none"> <li>• Sketch-Planning Tool</li> </ul>
FREEPLAN, ARTPLAN, and LOSPLAN	<ul style="list-style-type: none"> <li>• Sketch-Planning Tool</li> </ul>
Highway Capacity Software, 2010 (HCS2010)	<ul style="list-style-type: none"> <li>• HCM-Based Tool</li> </ul>
TRANSYT7-F	<ul style="list-style-type: none"> <li>• Optimization Tool</li> </ul>

Synchro Version 7.0	<ul style="list-style-type: none"> <li>• Optimization Tool</li> </ul>
Synchro Version 8.0	<ul style="list-style-type: none"> <li>• Optimization Tool</li> </ul>
SimTraffic Version 7.0	<ul style="list-style-type: none"> <li>• Microscopic Simulation Tool</li> </ul>
SimTraffic Version 8.0	<ul style="list-style-type: none"> <li>• Microscopic Simulation Tool</li> </ul>
SignCAD	<ul style="list-style-type: none"> <li>• Sketch-Planning Tool</li> </ul>
Trip Generation Software	<ul style="list-style-type: none"> <li>• Sketch-Planning Tool</li> </ul>

**Traffic Analysis Tool Selection Process**

Based on the recommended traffic analysis tool category or categories identified in Publication 46, Chapter 10.3, the process identified below should be used to identify the candidate software package(s) to be used when evaluating traffic capacity.

If the desired analytical or simulation software is not found within [Publication 46, Chapter 12.2](#):

- 1) A written request should be sent to the appropriate Engineering District Office for consideration;
- 2) Within the request, the reasons why an alternative analytical or simulation software should be clearly identified along with the added benefits of using the alternative software compared to the Department supported software platforms;
- 3) The Engineering District Office will evaluate each request and the District Traffic Engineer should provide a written response as to whether the alternative analytical or simulation software could be used on a particular project;
- 4) Note that an alternative analytical or simulation software analysis should not be submitted to the Department until a written response has been received by the District Traffic Engineer; and
- 5) If an Engineering District Office receives an alternative analytical or simulation software then coordination with the Bureau of Maintenance and Operations, Traffic Operations Section is recommended to ensure that an appropriate way of evaluating the accuracy of the model has been determined.

**Required Use by Department and Consultants**

Applicable work done by the Department, or by engineering consultants making submissions for Department review and approval, including but not necessarily limited to design, operational assessments, or Highway Occupancy Permit (HOP) projects, should use the 2010 Highway Capacity Manual (5<sup>th</sup> Edition) and supporting software packages as directed in Publication 46, Chapter 10 and [Chapter 12](#), unless directed otherwise in writing by the Department, and as dictated by a subject project’s scope of work.

Unless an alternative analysis tool is used, level-of-service (LOS) calculations and resultant measures of effectiveness should be calculated using the methodologies established by the 2010 Highway Capacity Manual (HCM2010) using a supported HCM-based tool identified in [Publication 46, Chapter 12.2](#). Currently, this means LOS calculations should be completed and reported using HCS2010.

---

**13 INTELLIGENT TRANSPORTATION SYSTEMS (ITS)**

Reserved Chapter